

SPIRACOUSTIC PLUS[®]

Spiral Duct Liner Installation Guide

Table of Contents

Section 1 – Spiracoustic Plus® System

State-of-the-Art Coated Lining for Spiral Duct

1-1. Introduction.....	4
1-2. Work Practice.....	4
1-3. Installation Questions.....	4
1-4. Ordering Information	4

Section 2 – Spiracoustic Plus® Spiral Liner

System Overview

2-1. Why Spiracoustic Plus® System?.....	5
2-2. Cost Savings in the Shop.....	5
2-3. Cost Savings in the Field.....	5
2-4. Additional Spiracoustic Plus® System Benefits.....	5
2-5. Where to Use Spiracoustic Plus® Liner	5
2-6. Where NOT to Use Spiracoustic Plus® System Products & Product Limitations	5
2-7. Negative Pressure Applications.....	6
2-8. Flat Oval Duct Applications	6
2-9. Specification Approval.....	6

Section 3 – System Components

3-1. Spiracoustic Plus® Spiral Liner Board.....	7
3-2. Spiracoustic Plus® Fitting Fab Board.....	9
3-3. SuperSeal® Coating Products.....	9

Section 4 – Spiracoustic Plus™ Spiral Duct

Project Estimating

4-1. A Complete System Approach.....	10
4-2. Design Sizes.....	10
4-3. Estimating Spiracoustic Plus® Spiral Liner Board	10
4-4. Estimating Tips	11
4-5. Suggested Scrap Percentages.....	11
4-6. Performing the Calculations.....	11
4-7. SuperSeal® Coating Products.....	12
4-8. SuperSeal® Availability	12
4-9. Estimate SuperSeal® Needs.....	12
4-10. Straight Duct Details for Spiracoustic Plus®.....	12
4-11. Impact of Duct Section Length.....	12
4-12. Impact of Connectors.....	12

4-13. Angle Rings	12
4-14. Proprietary Flange Systems.....	12
4-15. Slip Collars & Fitting Connections.....	12
4-16. Impact of Connectors.....	13
4-17. Tape Requirements.....	13
4-18. Estimating Tape Usage	13

Section 5 – Spiracoustic Plus® Installation in Straight Ducts

5-1. Preliminary Steps.....	15
5-2. Forming Liner Sections	15
5-3. Trial Fitting a Spiracoustic Plus® Spiral Liner Section	16
5-4. Characteristics of a “Good Fit”	17
5-5. Final Installation	18
5-6. Handling I.D. Reducing Connectors.....	19
5-7. Slip Joint Treatment	19
5-8. Liner Installation.....	20
5-9. Spiracoustic Plus® VVSD and VSD Installation....	21
5-10. Securing Spiracoustic Plus in Straight Duct.....	23
5-11. Securing Straight Sections – Vertical Duct or Risers	24
5-12. Fastening Requirements for Negative Pressure Systems	24

Section 6 – Fitting Considerations

6-1. Introduction to Fittings.....	25
6-2. Liner Securement Notes.....	25
6-3. SuperSeal Application Notes.....	26

Section 7 – Multiple Gore Elbows

7-1. Method One: Sheet Metal “Draw-band” Pattern.....	27
7-2. Method Two: Sheet Metal Elbow Gore (formed and seamed) as Pattern.....	30
7-3. Method Three: Sheet Metal Pattern, Cut in the Flat.....	30
7-4. Method Four: Miter Box/Band Saw Cutting.....	31
7-5. General Elbow Notes.....	31

Section 8 – Reducers

8-1. Method One: Concentric Conical Reducers
8" or Longer 32

8-2. Method Two: Multiple Segment Reducers..... 34

8-3. Method Three: Flat Pattern Layout..... 36

Section 9 – Branch Fittings/Tab-Ins

9-1. General Description..... 40

9-2. Liner Support Requirement for Branch Cut-Outs... 40

9-3. Straight Take-Offs..... 40

9-4. Conical Tees 41

9-5. Conical Tee Method One: "Vee" Notches
(Centerline)..... 41

9-6. Method Two: Flat Pattern Layout..... 45

9-7. Rectangular (Diffuser) Taps..... 47

9-8. Securement Options..... 47

Section 1 – Spiracoustic Plus® System Coated Liner for Spiral Duct

1-1. Introduction

Johns Manville developed the unique “snap-in” round liner concept in the mid-1990s to provide a cost-effective, user-friendly lining system for the growing spiral HVAC duct market.

Spiracoustic Plus duct liner is the original round liner system, and is protected by the following U.S. Patents: 5379806, 5487412, 5697282, 5762109, 5855154, 5953818 Other U.S. and foreign patents are pending.

1-2. Work Practice

Work practices described in this guide apply directly to JM Spiracoustic Plus System products, as proved in a wide variety of applications across North America.

Installation methods improve with each new project, but not all potential configurations are covered directly in this guide.

1-3. Installation Questions

Installation techniques for straight duct and common fittings are addressed by the information found in this Guide. It is the installing fabricator or contractor’s responsibility to ensure that Johns Manville Spiracoustic Plus System products are installed securely in the ductwork.

Please contact your Johns Manville representative regarding specific installation issues, job estimating, or applications not covered in this Guide.

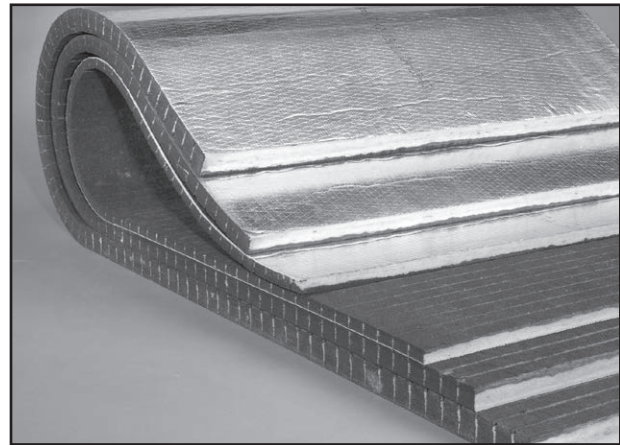

Figure 1-1. Spiracoustic Plus System

1-4. Ordering Information

Information about estimating material needs and standard product quantities is included in this guide. To order Spiracoustic Plus System products, please contact your JM Air Handling Distributor.

Order errors can be reduced or eliminated by taking extra care with notation regarding diameters. It is very common to confuse inside diameter (ID) and outside diameter (OD). For best results:

- Identify inside diameter of metal duct to be lined.
- Specify insulation thickness.
- Confirm that insulated duct inside diameter equals the thickness of the insulation (times 2) plus the ID of the duct to be lined.

For general questions about the use of Spiracoustic Plus duct liner, please contact your Johns Manville Regional Sales Office at the numbers listed on the back cover.

Section 2 – Spiracoustic Plus® Spiral Liner System Overview

2-1. Why Spiracoustic Plus® System?

JM's Spiracoustic Plus System is a complete, coated duct lining solution for a spiral air distribution ductwork.

Here's how it works: the Spiracoustic Plus system allows you to upgrade single-wall spiral ductwork to meet or exceed double-wall acoustical and/or thermal performance parameters, with reduced labor and material costs in both the shop and field.

2-2. Cost Savings in the Shop

Eliminating the perforated inner core of internally insulated spiral duct pays big dividends in the shop. Although Spiracoustic Plus duct liner is more expensive than light density wool or flexible liner, installed cost is often less than double-wall.

2-3. Cost Savings in the Field

With Spiracoustic Plus System liners, you are essentially installing single-wall duct. It offers many benefits versus double-wall, including:

- Easier material handling due to lower weight.
- Liner can be cost-effectively installed at the jobsite.
- No extra labor for double-wall connecting collars.
- Simplified field modifications and repairs.

2-4. Additional Spiracoustic Plus® System Benefits

Spiracoustic Plus duct liner offers additional key differences that make it the preferred choice over current spiral lining practices:

- No expensive perforated metal inner cores are required.
- Spiracoustic Plus System insulations are self-supporting when installed per JM directions (to 72" diameter).
- Straight sections of spiral supply duct normally require no pins or adhesive (to 72" diameter).

- Fitting applications typically require only minimal pinning and adhesive application.
- Performance is equal or superior to double-wall internally insulated duct.
- System approach eliminates the need to consider risky, expensive practice of installing flexible liner (without perforated core support) in spiral duct.
- Finally, JM stands behind the contractor, offering fitting and fabrication help in situations that are not covered within this guide.

2-5. Where to Use Spiracoustic Plus® Liner

Spiracoustic Plus liner replaces double-wall or flexible internal linings in spiral metal ductwork. The high thermal resistance (R) value of Spiracoustic Plus duct liner also allows it to replace external duct wrap, while adding acoustical performance.

2-6. Where NOT to Use Spiracoustic Plus® System Products & Product Limitations

Spiracoustic Plus System is designed to provide a durable, high performance lining system for spiral duct applications. However, there are places and circumstances where the use of Spiracoustic Plus products is not recommended, as listed in Table 2-1.

Spiracoustic Plus Spiral Duct Liner has design size range limits, as listed in Table 3-1, 3-2, 3-3, depending on the on thickness of the insulation.

Note: Do not force Spiracoustic Plus Board into duct diameters smaller than the design size!

Table 2-1. Limitations & Restrictions

The following list of limitations and restrictions is based on industry standards and good practice. Do not use Spiracoustic Plus duct liner in the following:

- In air duct systems operating continuously in excess of 250°F (121°C)
- Where velocities exceed 6,000 feet per minute (25.4 m/sec)
- In ducts used for conveying solids or particulates
- In kitchen or corrosive fume exhaust ducts
- In systems supplying hospital sensitive areas such as surgical suites, maternity wards, intensive care units and isolation areas where 90% effective (or greater) terminal filtration is not used
- Within six feet (1.8 m) of outside air intake grilles
- In air duct systems exposed to weather or buried below grade that are not sealed and protected against water incursion
- In contact with any HVAC equipment wet surface

2-7. Negative Pressure Applications

Negative pressure systems feature airflow similar to positive pressure systems and may be lined with Spiracoustic Plus System products. However, for a reliable installation it is essential to prevent air incursion, either from leakage or airflow turbulence, into the area between the metal duct wall and the FSK backing of Spiracoustic Plus spiral liner board. Due to limited air transmission of the backing, Spiracoustic Plus duct liner is subject to collapse in negative pressure applications if airflow occurs between the metal duct and the FSK backing.

Refer to Paragraph 5-12 (page 26) for installation details.

2-8. Flat Oval Duct Applications

Johns Manville does not recommend Spiracoustic Plus System products as a liner in flat oval duct.

JM has conducted several successful trial installations, but has not been able to demonstrate a significant cost benefit versus traditional double-wall in flat oval applications. Due to the flat configuration, Spiracoustic Plus System products require pins and adhesive application to ensure a reliable installation.

The flat sections are treated as panels in rectangular ductwork, with fasteners starting no more than 2" from the transition point from the radiused area. Workers must be able to gain access to apply the fasteners, which limits possible application to ducts with large aspect ratios.

2-9. Specification Approval

Spiracoustic Plus duct liner meets or exceeds mechanical code requirements for thermal/acoustical liner materials. The thermal and acoustical values of Spiracoustic Plus duct liner may allow reduced insulation thickness compared to typical light density insulations. However, because double-wall insulation thickness is typically specified to meet project-specific thermal and/or acoustical requirements, all insulation changes must be approved by the specifying authorities prior to installation.

It is the responsibility of the installing contractor to obtain specification or owner approval, preferably in writing, prior to the use of Spiracoustic Plus System products in any application.

Please contact your local Johns Manville Representative directly, or through your authorized Johns Manville Air Handling distributor, for specification assistance as needed.

Section 3 – System Components

3-1. Spiracoustic Plus® Spiral Duct Liner

For Spiral Metal Duct Applications, 6" I.D. or Greater

Spiracoustic Plus Spiral Duct Liner is a high-density coated insulation board, with factory-made kerfs, to allow installation in spiral ducts with diameters of 6" (1" thickness)

and larger (metal duct ID). Refer to product availability in Tables 3-1, 3-2 and 3-3. Prices for Spiracoustic Plus spiral duct liner are typically quoted per square foot.

Table 3-1. 1-Inch Thick Spiracoustic Plus Spiral Duct Liner

- Sheet Size - 48" x 120"
- Thermal Resistance - R-Value = 4.3
- Acoustical Absorption - NRC = 0.75

		Metal Duct OD	Finished ID
VVSD	Very, Very Small Diameter**	6" (min.) to 8"	4" (min.) to 6"
VSD	Very Small Diameter*	10" (min.) to 16"	8" (min.) to 14"
SD	Small Diameter	18" (min.) to 30"	16" (min.) to 28"
LD	Large Diameter	32" (min.) and up	30" (min.) and up

* Fabrication Note: All Spiracoustic Plus VVSD and VSD duct liner installations in metal ducts must be sized for a slip-in fit. Refer to Paragraph 5-9 Spiracoustic Plus VVSD and VSD for additional details. Minimum diameters have been established and must be observed to prevent damage to the liner during installation.

** VVSD available in 1" thickness only

Description	Package Type	Sheets/Package	Sq. Ft./Package
1" x 48" x 120" VVSD	Carton	6	240
1" x 48" x 120" VSD	Carton	6	240
1" x 48" x 120" SD	Carton	6	240
1" x 48" x 120" LD	Carton	6	240
1" x 48" x 120" Fab	Carton	6	240
1" x 48" x 120" Fab	Pallet	48	1,920
1" x 48" x 120" VVSD	Pallet	48	1,920
1" x 48" x 120" VSD	Pallet	48	1,920
1" x 48" x 120" SD	Pallet	48	1,920
1" x 48" x 120" LD	Pallet	48	1,920

Note: Fitting fab board is uncut Spiracoustic Plus Board, available for lining fittings with flat panels. Fitting fab board is available in pallets or cartons.

Table 3-2. 1.5-Inch Thick Spiracoustic Plus Spiral Duct Liner

- Sheet Size - 48" x 120"
- Thermal Resistance - R-Value = 6.4
- Acoustical Absorption - NRC = 0.85

		Metal Duct ID	Finished ID
VSD	Very Small Diameter*	14" (min.) to 20"	11" (min.) to 17"
SD	Small Diameter	22" (min.) to 38"	19" (min.) to 35"
LD	Large Diameter	40" (min.) and up	37" (min.) and up

* Fabrication Note: All Spiracoustic Plus VSD installations in metal ducts must be sized for a slip-in fit. Refer to Paragraph 5-9 Spiracoustic Plus VSD for additional details. Minimum diameters have been established and must be observed to prevent damage to the liner during installation.

Description	Package Type	Sheets/Package	Sq. Ft./Package
1.5" x 48" x 120" VSD	Carton	4	160
1.5" x 48" x 120" SD	Carton	4	160
1.5" x 48" x 120" LD	Carton	4	160
1.5" x 48" x 120" Fab	Carton	4	160
1.5" x 48" x 120" Fab	Pallet	32	1,280
1.5" x 48" x 120" VSD	Pallet	32	1,280
1.5" x 48" x 120" SD	Pallet	32	1,280
1.5" x 48" x 120" LD	Pallet	32	1,280

Note: Fitting fab board is uncut Spiracoustic Plus board, available for lining fittings with flat panels. Fitting fab board is packaged in cartons or pallets.

Table 3-3. 2-Inch Thick Spiracoustic Plus Spiral Duct Liner

- Sheet Size – 48" x 120"
- Thermal Resistance – R-Value = 8.4
- Acoustical Absorption – NRC = 0.95

		Metal Duct ID	Finished ID
VSD	Very Small Diameter*	18" (min.) to 24"	14" (min.) to 20"
SD	Small Diameter	26" (min.) to 58"	22" (min.) to 54"
LD	Large Diameter	54" (min.) and up	50" (min.) and up

* Fabrication Note: All Spiracoustic Plus VSD and 2" Spiracoustic Plus SD installations in metal ducts with inside diameters of less than or equal to 30 inches must be sized for a slip-in fit. Refer to Paragraph 5-9 Spiracoustic Plus VSD for additional details. Minimum diameters have been established and must be observed to prevent damage to the liner during installation.

Description	Package Type	Sheets/Package	Sq. Ft./Package
2" x 48" x 120" VSD	Carton	3	120
2" x 48" x 120" SD	Carton	3	120
2" x 48" x 120" LD	Carton	3	120
2" x 48" x 120" Fab	Carton	3	120
2" x 48" x 120" Fab	Pallet	24	960
2" x 48" x 120" VSD	Pallet	24	960
2" x 48" x 120" SD	Pallet	24	960
2" x 48" x 120" LD	Pallet	24	960

Note: 2" Spiracoustic Plus duct liner is a made-to-order item.

3-2. Spiracoustic Plus® Fitting Fab Board

For Flat Panel Applications in Fittings

Non-kerfed Spiracoustic Plus board for special fitting applications. Refer to product availability tables.

3-3. SuperSeal® Coating Products

SuperSeal Coating Products are water-based, air-dry versions of JM's factory-applied airstream coating designed for edge coating, resealing fabrication cuts and for repair of gaps or damage to the airstream surface of the lining. SuperSeal HV™ coating was specifically

designed with additional adhesive and fill characteristics for use with Spiracoustic Plus System insulations.

Proper application of SuperSeal coating products maintains the UL Listing, acoustical performance and code compliance of Spiracoustic Plus linings.

Use of nonrated products in lieu of Johns Manville SuperSeal coating products will void the limited warranty, and may compromise building code compliance.

SuperSeal Products are typically priced by shipping unit. Refer to product availability in Table 3-4.

Table 3-4. Spiracoustic Plus Accessory Coatings

SuperSeal Products

Product	Shipping Unit	Contents of Shipping Unit
SuperSeal Edge Treatment	Pail	One - 5 gal. pail
SuperSeal Edge Treatment	Carton	Four - 1 gal. pails
SuperSeal HV	Carton	Four - 1 gal. pails

SuperSeal Notes:

- SuperSeal prices are net per shipping unit; partial shipping units are not available.
- SuperSeal products are water-based and **MUST BE PROTECTED FROM FREEZING**; shipping restrictions may apply.

Section 4 – Spiracoustic Plus® Spiral Duct Project Estimating

4-1. A Complete System Approach

Using JM’s Spiracoustic Plus System, the full range of spiral duct diameters can be lined with durable, high-density coated insulation products.

Selection of proper Spiracoustic Plus System components is essential for an accurate estimate. This section provides important information to ease that process.

A simple example of a Material Estimating Worksheet is shown in Table 4-5, page 16.

Caution

It is the responsibility of the contractor or fabricator to determine labor requirements, material quantities and all other related project functions. As with any new product or technology, a learning curve should be anticipated for initial Spiracoustic Plus System applications.

Johns Manville provides this Guide as a service to our customers, and will not be held liable for costs or damages incurred from specification, purchase, or application of Spiracoustic Plus System products.

4-2. Design Sizes

Spiracoustic Plus spiral duct liner has limits to the design size range. See Tables 4-1, 4-2 and 4-3.

Do not force Spiracoustic Plus board into duct with diameters smaller than the design size!

Table 4-1. 1" Spiracoustic Plus Duct Liner Minimum ID*

1" VVSD	6" spiral duct (metal) ID
1" VSD	10" spiral duct (metal) ID
1" SD	18" spiral duct (metal) ID
1" LD	32" spiral duct (metal) ID

Table 4-2. 1.5" Spiracoustic Plus Duct Liner Minimum ID*

1.5" VSD	14" spiral duct (metal) ID
1.5" SD	22" spiral duct (metal) ID
1.5" LD	40" spiral duct (metal) ID

Table 4-3. 2" Spiracoustic Plus Duct Liner Minimum ID*

2" VSD	18" spiral duct (metal) ID
2" SD	26" spiral duct (metal) ID
2" LD	54" spiral duct (metal) ID

* Failure to observe minimum diameter will void Johns Manville warranties.

4-3. Estimating Spiracoustic Plus® Spiral Liner Board

Spiracoustic Plus is supplied in VVSD (very, very small diameter), VSD (very small diameter), SD (small diameter) and LD (large diameter) configurations. To accurately estimate liner requirements, it is necessary to calculate the net square feet of liner and add an appropriate scrap percentage.



Figure 4-1. Spiracoustic Plus Duct Liner

4-4. Estimating Tips

For best results, follow these guidelines:

- Calculate fitting requirements by measuring length through the centerline.
- Reducers or other fittings that change diameter should be calculated using the largest diameter.
- For most jobs, fittings and straight duct lining should be calculated separately, as scrap requirements typically differ.
- Optimize metal duct when possible to match the 120" liner board dimension.
- Note that the job estimated may require Spiracoustic Plus VVSD, VSD, SD, LD, fab board, or any combination of the products.
- It is better to have too much product than not quite enough. Work with your JM distributor to ensure sufficient inventory to complete the project.

4-5. Suggested Scrap Percentages

The percentages provided in Table 4-4 below for Spiracoustic Plus spiral duct liner are guidelines only, subject to change with experience and individual job conditions. Optimizing the job for Spiracoustic Plus products, as described in this Guide, will have a positive impact on scrap.

To minimize scrap, save drop-off sections of liner and piece them together. Scrap savings must be weighed against added labor cost.

Table 4-4. Scrap Percentages

Scrap Add-on	Shop	Field*
Straight Duct	4 - 10%	5 - 20%
Fittings	8 - 18%	10 - 25%

* Scrap is dramatically reduced by saving and sectionalizing drop-off lengths.

4-6. Performing the Calculations

Today, most shops use spreadsheets or specialized computer estimating programs. As a refresher, some basic manual calculations follow.

Step 1. Calculate duct circumference in feet. Multiply the duct inside diameter (d), in inches, by ($\pi = 3.1416$), and divide the result by 12 to convert to feet:

$$\begin{aligned} \text{circumference in feet} &= (d'' \times \pi) / 12 \\ &= (d'' \times 3.1416) / 12 \end{aligned}$$

$$\begin{aligned} \text{or use C (constant)} &= 3.1416 / 12 \\ &= .262 \end{aligned}$$

$$\text{circumference in feet} = (d'' \times C)$$

Example for a 28" diameter duct:

$$\begin{aligned} \text{circumference in feet} &= (28'' \times .262) \\ &= 7.34 \text{ feet (88 inches)} \end{aligned}$$

Step 2. Calculate amount of duct surface to be lined, in square feet. Multiply the circumference from Step 1 by the the total lineal feet (tLF) of duct with that diameter to be lined:

$$\text{Net Square Feet (nSF)} = \text{tLF} \times \text{circumference in feet}$$

Example for 108 feet of duct, 28" diameter:

$$\begin{aligned} \text{Net Square Feet (nSF)} &= 108 \text{ lineal feet} \times 7.34 \\ &= 792.3 \text{ Square Feet} \end{aligned}$$

Step 3. Add a percentage for scrap. In this case, 4% scrap (from Table 4-4 for straight duct) will be added to the nSF result:

$$\text{Total Square Feet (tSF)} = (1 + \text{scrap factor}) \text{ Net Square Feet (nSF)}$$

Example with 4% scrap

$$\begin{aligned} \text{Total Square Feet (tSF)} &= (1 + .04) \times \text{Net Square Feet (nSF)} \\ &= 1.04 \times 792.3 \text{ Net Square Feet (nSF)} \\ &= 823.3 \text{ Square Feet} \end{aligned}$$

Step 4. Calculate the Total Square Feet required for each diameter. Total the job square foot requirements of Spiracoustic Plus VVSD, VSD, SD and LD separately. Refer to the sample Material Estimating Worksheet in Table 4-5 (page 14).

4-7. SuperSeal® Coating Products

Johns Manville recommends SuperSeal products for fabrication or repair coating applications on Spiracoustic Plus System products.

Use of SuperSeal products preserves the high performance formulated into the factory-applied airstream coating, maintaining system integrity. SuperSeal products also meet NFPA 90A and 90B requirements, and comply with all North American building codes.

Use of non-rated products in lieu of Johns Manville SuperSeal products will void all product warranties and may compromise building code compliance.

4-8. SuperSeal® Availability

Complete SuperSeal product order information is described in paragraph 3-3 and Table 3-4. For technical information, please refer to Spiracoustic Plus product data sheet HVAC-444 or individual SuperSeal product data sheet HVAC-202.

SuperSeal HV coating was designed specifically for the needs of Spiracoustic Plus System liners. Available in one-gallon pails, SuperSeal HV coating performs as a mastic and filler.

4-9. Estimate SuperSeal® Coating Needs

SuperSeal coating use is difficult to estimate because requirements vary by job conditions and applicator habits. One-gallon pails, packaged four to a carton, each contain 128 U.S. fluid ounces.

A conservative estimate allows a gallon pail of SuperSeal HV coating for every 2,000 square feet of spiral duct liner. That requirement could easily double if the following guides are not observed:

- Cut fittings with care to minimize filler requirement.
- Line large diameter duct on the job site to avoid damage to the lining during transit.
- Properly seal SuperSeal pails after use.

4-10. Straight Duct Details for Spiracoustic Plus®

When estimating, detailing or ordering spiral metal duct to be lined with Spiracoustic Plus System products, some simple practices can reduce overall cost and improve installed quality.

Factors that influence Spiracoustic Plus System spiral liner installation include:

- Straight duct section length
- Type of joint connector used
- Length of fitting end gores and/or throats
- Reducer length

Fitting practice will be discussed in Section 6.

4-11. Impact of Duct Section Length

To work efficiently with the 48" net liner section length of Spiracoustic Plus liner sections, specify metal duct lengths in four-foot increments.

For example, using a 96" (8') long duct section instead of 120" (10') will allow the insulation to be inserted into the duct for a flush fit. This principle applies to any duct length. The simple rule of thumb is to fabricate duct sections in increments of four feet. Note that any length duct can be lined with Spiracoustic Plus insulation, as long as the diameter allows sufficient access to ensure a gap-free liner installation.

4-12. Impact of Connectors

In general, any connecting device (or accessory) that reduces duct ID or is secured with fasteners that penetrate the duct wall, will impact Spiracoustic Plus liner installation. The smaller the duct diameter, the greater the effect.

Note

Flange-type connections are preferred, but not required with spiral duct systems lined with Spiracoustic Plus products.

Flange connections simplify duct hanging and installation, and provide reinforcement for the duct during handling. Typically, the labor benefits gained are offset by the added cost of a flange system (compared to slip-joint collars).

4-13. Angle Rings

Angle iron rings, welded flush with the duct end or with Van Stone flanges, provide the least resistance to Spiracoustic Plus liner installation because there is no reduction of the interior dimension of the metal duct. This type of connection is not common in HVAC applications because of cost, but may be worth considering on large jobs to be lined. Spiracoustic Plus liners work well with angle iron connectors, although screws, if used, may need to be backed out or removed prior to liner installation.

4-14. Proprietary Flange Systems

The growth of spiral and oval duct systems has led to the introduction of new, proprietary flange systems. The flange systems differ somewhat in detail and application, but have two common traits that impact Spiracoustic Plus System liner installation:

- Flanges typically install into the ID of the duct, slightly reducing the ID at the ends, but not in the center.
- Flanges may be secured with screws, blind or solid rivets, spot welds or skip-tack welds. Screws and rivets, depending on length, can complicate installation and damage the FSK facing of Spiracoustic Plus Board. Screws must be backed out or rivets flattened to install Spiracoustic Plus.

In spite of the cautions noted above, several large installations have been done using proprietary flange systems.

4-15. Slip Collars & Fitting Connections

Standard connecting collar and slip-fit joints slightly reduce the inside diameter on the end of the sections. Also, slip-collar connections may snag on the FSK facing of Spiracoustic Plus spiral duct liner if precautions are not taken.

Note that any problems related to straight slip-collar connections are compounded by crimping the collar or fitting ends.

Recommendations for installing Spiracoustic Plus spiral duct liner into duct systems using slip-in connecting collars and fittings will be detailed in Section 5.

4-16. Impact of Connectors

Spiracoustic Plus VVSD and VSD duct liner is not normally affected by slip-joint or other ID-reducing duct connections. Spiracoustic Plus VVSD and VSD duct liner is not compressed prior to installation, but sized for a slip-in fit. Screws must be backed out or rivets flattened to install Spiracoustic Plus VVSD and VSD duct liner.

4-17. Tape Requirements

Johns Manville recommends UL 181 A-P pressure sensitive tape systems, UL 181 A-H heat-applied tape systems or UL Classified tape systems for use on the Spiracoustic Plus System products. Use of non-approved UL tapes will void all product warranties and may compromise building code compliance.

For VSD installations, the use of UL classified FSK facing tapes is recommended, but UL classified FSK tape is not required. We recommend UL classified FSK tape because this tape will provide additional strength during the fabrication process.

UL 181A tapes are typically referred to as “duct board tapes” and are available from authorized Johns Manville Air Handling Distributors. These high-performance tape products are more costly than standard commodity foil tapes because they are designed specifically for air duct applications and comply with all building code requirements.

4-18. Estimating Tape Usage

Tape is required for sealing the FSK facing of Spiracoustic Plus liner board and Spiracoustic Plus fitting fab board. Calculate usage as follows:

- Straight Duct: for ducts 38” in diameter and smaller, allow 6.5 feet for each 4’ liner section (includes crosstabs); for ducts larger than 38” in diameter, additional tape will be required.
- Ells or Straight-through Fittings: allow 6.5 feet for each 4’ liner section (includes cross-tabs).
- Reducing Fittings: allow 12 feet of tape for each foot of reducer length, when using Spiracoustic Plus duct liner sections.
- Scrap/Loss: figure 10% to 15% scrap for pressure sensitive, 5% to 8% scrap for thermal tape.

Table 4-5. Material Estimating Worksheet, JM Spiracoustic Plus System
 Sample estimate; 1" insulation thickness

1" Spiracoustic Plus Very Small Diameter (VSD) Duct Liner
Metal ID Range: 10" through 16"

Enter Metal Duct ID	Calculated Duct SO	Enter Duct Lin. Feet	Scrap Factor	Calculated # Ins. Sections	Calculated SF Insulation
12	37.70	140	5%	35	461.8
16	50.26	112	5%	28	492.6

1" VSD Total SF: 954.4
 Pallets: 0.5
 (or) Cartons: 5.0

1" Spiracoustic Plus Small Diameter (SD) Duct Liner
Metal ID Range: 18" through 30"

Enter Metal Duct ID	Calculated Duct SO	Enter Duct Lin. Feet	Scrap Factor	Calculated # Ins. Sections	Calculated SF Insulation
20	62.83	60	5%	15	329.9
24	75.40	200	5%	50	1,319.4
28	87.96	108	5%	27	831.2

1" SD Total SF: 2,480.5
 Pallets: 1.3
 (or) Cartons: 11.0

1" Spiracoustic Plus Large Diameter (LD) Duct Liner
Metal ID Range: 32" and larger

Enter Metal Duct ID	Calculated Duct SO	Enter Duct Lin. Feet	Scrap Factor	Calculated # Ins. Sections	Calculated SF Insulation
34	106.81	190	5%	47.5	1,775.7
40	125.66	144	5%	36.0	1,583.3
52	163.36	38	5%	9.5	543.2
60	188.49	60	5%	15.0	989.6

1" LD Total SF: 4,891.8
 Pallets: 2.5
 (or) Cartons: 21.0

Section 5 – Spiracoustic Plus® Installation in Straight Ducts

5-1. Preliminary Steps

5-1.1. Work Area. Prepare a clean, dry work area. A work table is highly recommended. Alternately, the cardboard carton or pallet top may be used for floor cutting or sectionalizing.

Note

The following instructions are for Spiracoustic Plus SD duct liner and Spiracoustic Plus LD duct liner installations. For Spiracoustic Plus VVSD and VSD duct liner installation, refer to Paragraph 5-9.

5-1.2. Determine Circumference. Obtain the actual circumference of the duct to be lined. Because duct diameters vary due to differences in metal gauge and fabrication equipment, it is important to determine internal circumference using a flat flexible tape.

Note

DO NOT place the tape on internal flange or collar connectors. Use the actual duct wall for the measurement. Internal flanges or collars that reduce ID at the ends may require additional stretchout adjustments, as described later in this section.

5-1.3. Calculate Stretchout. Initial Spiracoustic Plus liner stretchout should be cut approximately 1/2" less than the actual measured duct circumference. Use the first liner section as a trial piece, or cut a strip of liner, 4 to 6 inches wide, to verify the correct stretchout.

For stretchouts exceeding the 120" length of Spiracoustic Plus sheets, additional material must be added. Add-on sections should be taped in place in the flat before the final circumference is measured and trimmed.

Note

Determining the proper stretchout is critical for a good spiral liner installation. Do not automatically cut along the factory kerf unless that is where the measurement falls. Circumference adjustments of $\pm 1/8$ " can change a tight or loose fit to a desirable fit.

5-1.4. Connector Allowances. In the following sections of this Guide, FSK facing trim requirements and other adjustments necessary to accommodate connecting systems will be reviewed. For best results, liner trimming should be made in the flat, prior to forming into round sections.

5-2. Forming Liner Sections

5-2.1. Place the Spiracoustic Plus duct liner section on the work table, coated (airstream) side up. The example shown in Figure 5-1 is being "pre-broken" along a factory kerf, approximately in the center. Without pre-breaking, sections may crease diagonally across the kerfs when the formed section is installed in the duct.

5-2.2. For SD and LD sizes apply closure tabs (8" long (minimum) tape cross-tabs of UL 181A duct board closure

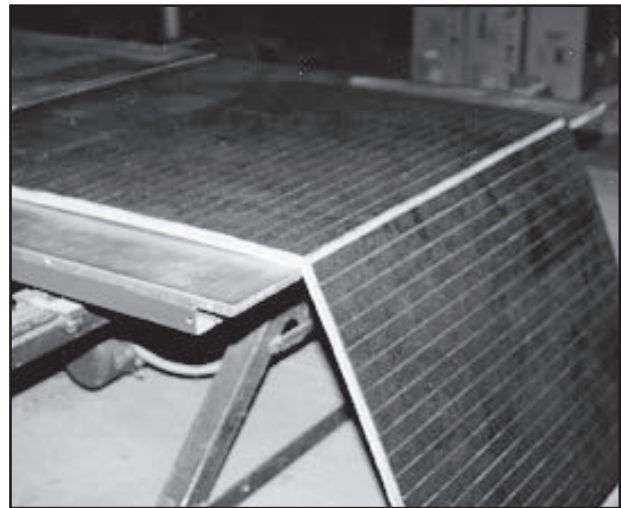

Figure 5-1. Pre-broken Spiracoustic Plus Duct Liner

tape) perpendicular to the butt-edge seam, approximately 12" (minimum) on centers, three per side, as shown in Figure 5-2. For VVSD and VSD sizes, UL classified FSK facing tape is recommended (refer to paragraph 4-17), for the cross-tabs approximately 6" (minimum) on centers, six per side to add additional strength. Alternatively, a staple flap may be used. Add 2" (min.) to the required stretchout. Clean the fiberglass from the flap, leaving the FSK facing overlap for stapling. Staples should be 1/2" (min.) outward-clench type on approximately 2" centers.



Figure 5-2. Closure tabs

5-2.3. Form the Spiracoustic Plus spiral duct liner to the measured diameter (FSK facing to the outside), and pull the butt-seam joint tightly together before rubbing down the tape tabs. Take care to align the section ends. See Figure 5-3.

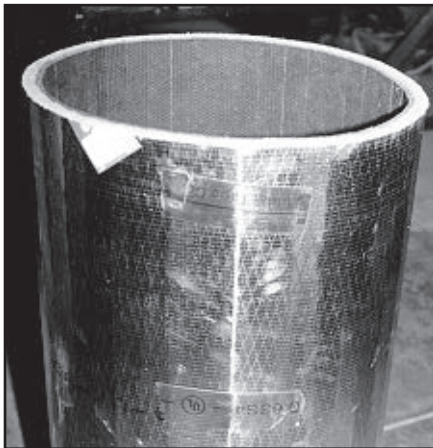

Figure 5-3. Joint taped

5-2.4. Finish either type of joint closure by covering the seam with an approved UL 181A closure, applied equally to each side of the seam. If thermal closure is used, ABI dots must be darkened by a combination of heat and pressure. If pressure-sensitive closure is used, the scrim in the liner facing must be clearly visible through the tape foil following the application, through use of a squeegee or other rubbing device. See Figure 5-4.

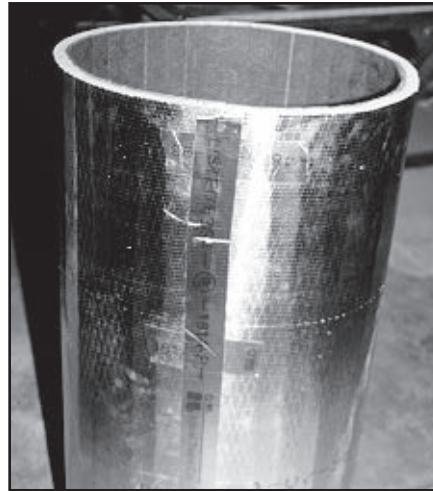

Figure 5-4. Finished joint closure

5-3. Trial Fitting a Spiracoustic Plus® Spiral Liner Section

The first section (or trial strip) should be installed into the duct far enough to clear flange or collar connectors at the duct end. Refer to Figures 5-5 through 5-9 and the following instructions.

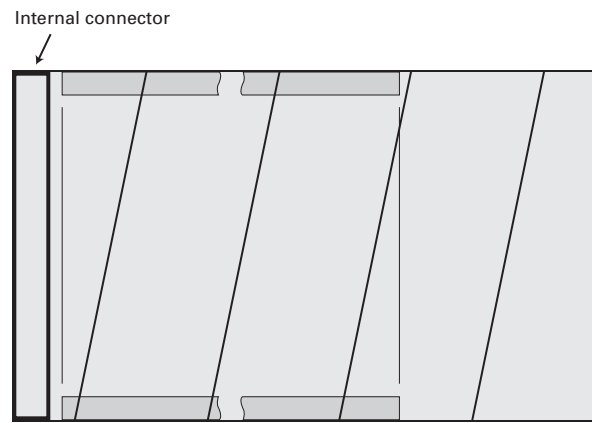

Figure 5-5. Trial fit

Note

During trial fit, make sure the insulation section is not over-lapping any connecting collars and is fitted squarely into the duct.

5-3.1. Formed liner section ready for trial fit in spiral duct is shown in Figure 5-6.



Figure 5-6. Formed liner and spiral duct

5-3.2. Collapse the formed insulation section by folding the Spiracoustic Plus duct liner inward (approximately opposite of seam) into roughly a “heart shape,” taking care not to fold diagonally across the kerfs or directly on the tape seam. See Figure 5-7.



Figure 5-7. Liner folded inward

5-3.3. Slide the collapsed liner section into the duct and locate in the desired position, taking care to ensure that the insulation is square with the duct. See Figure 5-8. The trial liner section should be positioned so that there is no interference with any internal connectors or accessories.

5-3.4. Push (“expand”) the folded portion outward until it fits tightly inside the spiral, with no ripples or overlapping sections. Check for snugness of fit. See Figure 5-9.

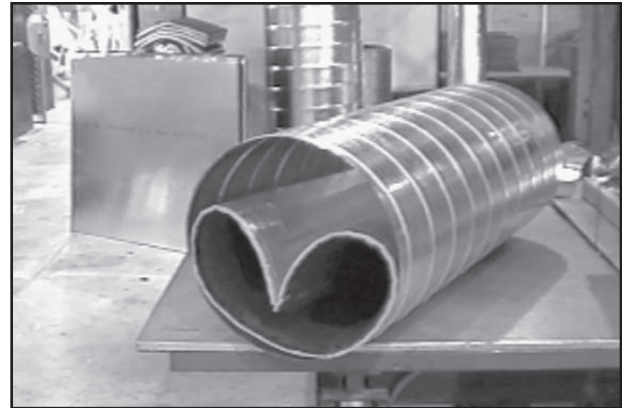

Figure 5-8. Folded liner in duct

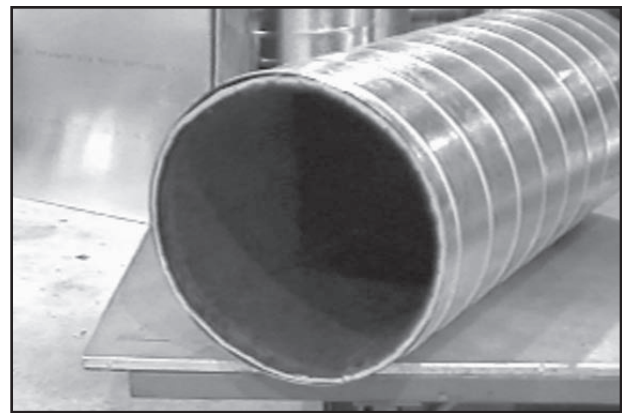

Figure 5-9. Liner expanded

5-4. Characteristics of a “Good Fit”

Spiracoustic Plus LD & SD Duct Liner Only

The insulation section should “snap” into place with little or no gap between the duct and liner. A properly sized liner requires considerable force to slide within the duct, and the segments (“blocks” of insulation) should not be wrinkled, or show overlap or misalignment of more than approximately 1/8”. See Figure 5-10.

A fit that is too tight will require force to expand the liner, and may result in visible misalignment or wrinkling of the segments. A loose fit is indicated by gaps of 1/4” or greater in one or more areas. Keep in mind that (depending on duct diameter) adding or subtracting 1/8” may provide enough adjustment if the fit is not quite right.

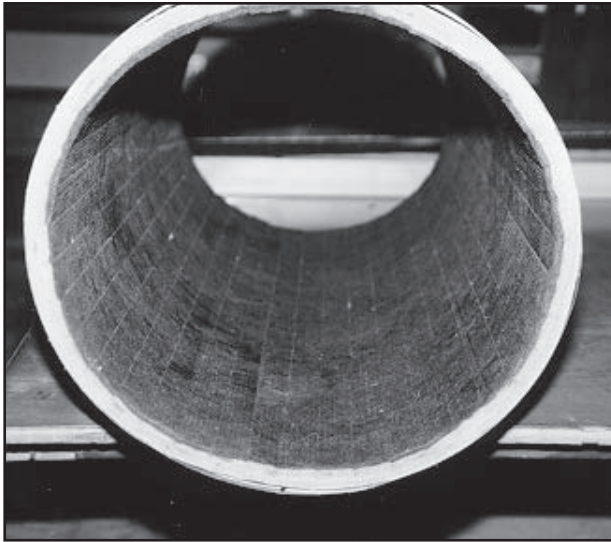

Figure 5-10. Finished duct and liner

5-5. Final Installation

Spiracoustic Plus LD & SD Duct Liner Only

With the stretchout established, consider the connector type (discussed below) and perform all necessary cutting and/or trimming in the flat for best results. Refer to Figures 5-6 to 5-11.

5-5.1. Collapse the insulation into a “heart shape,” taking care not to fold across the kerfs or directly on the tape seam. Position the section carefully into the duct, taking care to ensure that it is square and flush with the end.

With the insulation section properly aligned, release pressure and allow the Spiracoustic Plus to “snap” into place.

5-5.2. Working from the opposite end of the metal duct, where the first liner section was installed, install subsequent sections by butting securely against the preceding sections. Factory edge-coated ends do not require additional coating prior to installation.

Note

When metal duct lengths are sized to accommodate more than two liner sections, be sure the duct is large enough to allow access.

5-5.3. When the lining is completed, trim any overhangs off flush with the metal, using the flange as a guide.

5-5.4. Check for damage or gaps in the lining. Any gaps less than 1/2” should be filled with SuperSeal HV coating. Gaps or voids greater than 1/2” must be repaired by cutting and inserting a suitable patch section. The patch must be coated on all edges with SuperSeal HV coating before installation. After patching, butter the airstream surface with SuperSeal HV coating.

5-5.5. Optionally, a 1/4” bead (approx.) of SuperSeal HV coating may be applied to both liner edges prior to section assembly to ensure a sealed insulation joint.

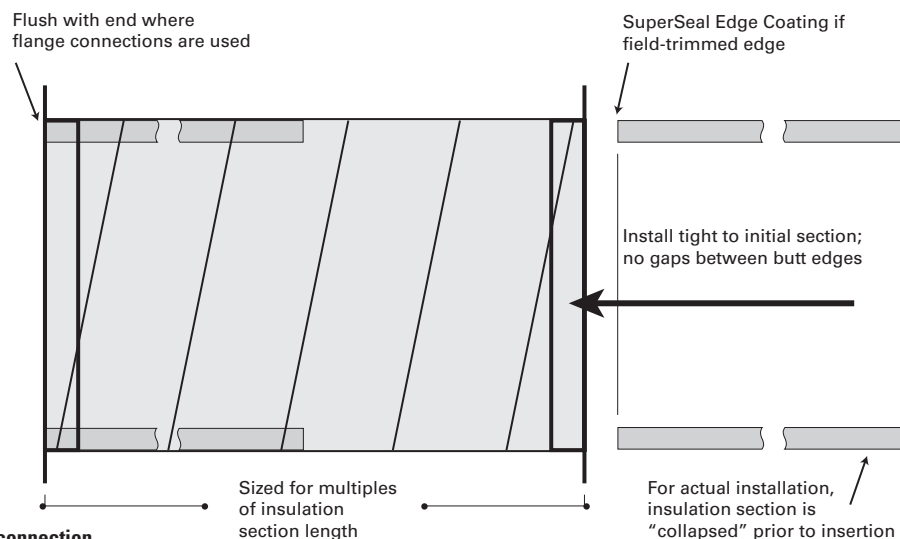

Figure 5-11. Duct connection

5-6. Handling ID Reducing Connectors

The type of duct connector being used may require additional preparation before the liner section is installed. For slip collars or other internally-lapping flange connectors, it may be desirable to trim back the facing of the Spiracoustic Plus spiral duct liner back from the joint by approximately the width of the slip collar. Refer to Figure 5-12.

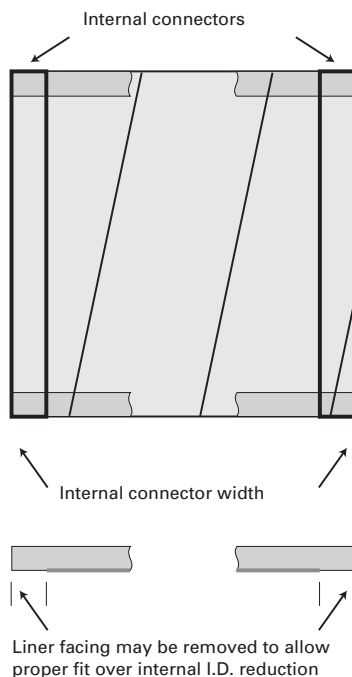

Figure 5-12. Internal connection

In general, the smaller the duct, the greater the benefit of trimming the facing. Untrimmed FSK can form a challenging barrier to a slip collar, resulting in liner damage and difficult collar assembly from the inevitable hammer attack that occurs.

Proprietary flange systems that are pre-assembled on the duct don't pose the same assembly problem, but reduce the diameter at the ends. Depending on stretchout, the fit of the Spiracoustic Plus liner can be altered by the change in diameter.

5-7. Slip Joint Treatment

If some simple precautions are not observed, the FSK facing of Spiracoustic Plus board can frustrate attempts to install slip collars or slip-in fitting ends.

5-7.1. Collar/Connector Size

Some shops undersize collars as much as 1/2," or use aggressive crimping to ease installation. This practice doubtlessly saves field assembly time with single-wall, unlined duct, but will almost certainly add time for duct lined with Spiracoustic Plus spiral duct liner.

Consider the impact of reduction of duct ID by the inside lap of the slip joints:

- Minimal ID reduction, where slip joints are accurately sized to duct diameter, typically requires only trimming the FSK facing from the liner sections in areas where the collars overlap.
- Significant ID reduction, as a result of loose-fit slip joints and/or crimping, requires facing trimming, and may also require removal of 1/8" of the fiberglass liner OD (liner-to-duct surface) in areas where the collars overlap.

5-7.2. Slip Joint Overlap

The standard overlap width of slip joint connections is normally 2" for both collars and fitting ends. For duct to be lined with Spiracoustic Plus spiral duct liner, it is important that the dimension be consistent.

5-7.3. Duct Pre-Assembly

When multiple straight duct sections will be joined using slip collars, pre-assemble the collar to one end of each duct section prior to liner installation. For best results, do not install screws to secure collars until the liner is in place.

5-8. Liner Installation

Duct With Slip Joint Connections

5-8.1. Liner sections must be prepared with FSK facing trimmed back for clearance where internal collars or fitting slip joint connections will reduce duct inside diameter. Refer to Figure 5-13. FSK facing trimming is done most effectively while insulation is still in the flat.

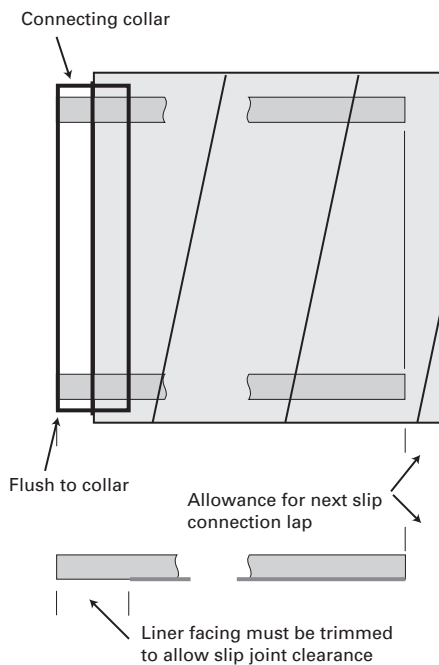

Figure 5-13. Internal collar or slip joint

5-8.2. With slip collar connectors pre-installed in one end of each straight duct, the first section (starter, or initial section) of Spiracoustic Plus duct liner should be installed with the liner flush with the installed collar.

5-8.3. Collapse the insulation into a “heart shape” (see Figure 3-7), taking care not to fold diagonally across the kerfs or directly on the tape seam. Position the section carefully into the duct. Check to assure that the insulation is square with the duct before releasing pressure and “snapping” into place.

5-8.4. Working from the opposite end of the metal duct, where the initial section was installed, install subsequent sections by butting securely against the preceding sections. Factory edge-coated ends do not require additional coating prior to installation.

Note

When metal duct lengths are sized to accommodate more than two liner sections, be sure the duct is large enough to allow access.

5-8.5. The final liner section must be cut back 2” (or the alternate width of the collar or fitting straight to be inserted into the duct for assembly) for clearance. Measure carefully from the square shoulder of the last liner section and make a straight cut on the bench before forming the liner for installation.

5-8.6. If the factory edge-coated end is trimmed off, butter the cut edge with SuperSeal HV coating, or other Johns Manville SuperSeal product prior to installation of the liner section.

5-8.7. Check for damage or gaps in the lining. Any gaps less than 1/2” should be filled with SuperSeal HV coating. Gaps or voids greater than 1/2” must be repaired by cutting and inserting a suitable patch section. The patch must be coated on all edges with SuperSeal HV coating before installation. After patching, butter the airstream surface with SuperSeal HV coating.

5-8.8. Optionally, a 1/4” bead (approx.) of SuperSeal HV coating may be applied to both liner edges prior to section assembly to ensure a sealed insulation joint.

Note

When hanging and assembling lined sections and fittings using slip collars, use care not to damage the liner with spoons or other tools. If damage occurs, repair as outlined in paragraphs 5-5 through 5-8.

5-9. Spiracoustic Plus® VVSD and VSD Installation

Spiracoustic Plus LD and SD products are typically designed for a “snap-in” installation, as illustrated in Figure 5-8. The small diameters of Spiracoustic Plus VVSD, VSD and 2” SD duct liner do not allow the material to be collapsed and installed using this method. These products must be installed using a slip-fit, with no collapsing into a “heart shape” or any additional compression.

5-9.1. The products listed below must be sized for slip-fit installation:

- 1” VVSD, all diameters in range
- 1” VSD, all diameters in range
- 1.5” VSD, all diameters in range
- 2” VSD, all diameters in range
- 2” SD, diameters of 30” or less in diameter range

5-9.2. To determine stretchout, use a flat tape and measure the circumference of the inside of the duct to be lined. Subtract 1/4” from the measurement to establish an initial stretchout for the Spiracoustic Plus VVSD and VSD insulation. Note that additional stretchout adjustment may be required, depending on diameter range.

See Figure 5-14.



Figure 5-14. Measuring for stretchout

5-9.3. After the insulation section is measured and cut, it must be formed and the seam closed securely. Forming sections can be challenging with the smallest diameters. Consider using straps or draw-bands to hold the material closed while cross-tabs of UL 181A tape closure are applied. See Figures 5-15, 5-16, 5-17, 5-18 and 5-19. A work bench with a fixed backstop is preferred, if available.

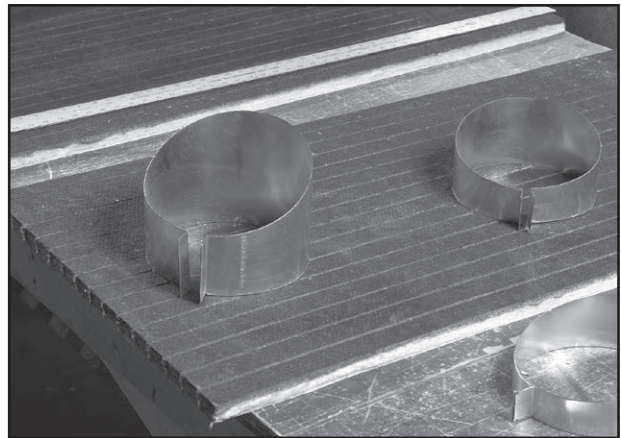

Figure 5-15. Draw-bands to hold material closed. Note the angle on the draw-bands; they also serve as a cutting guide.



Figure 5-16. First draw-band in place with clamp

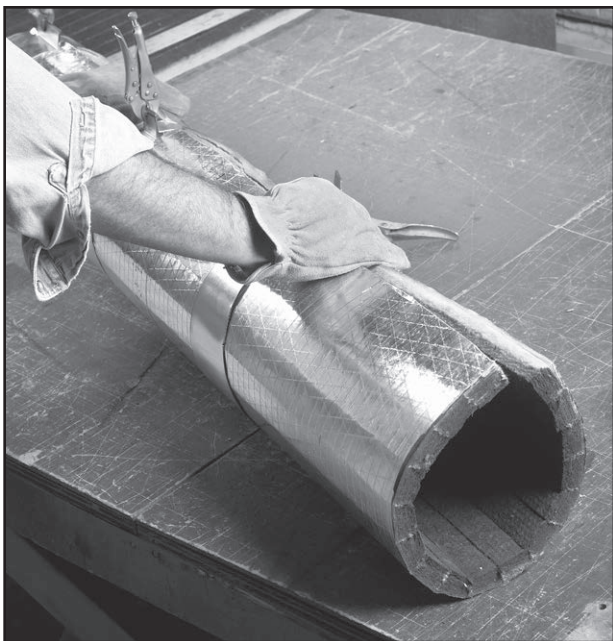

Figure 5-17. Clamping additional draw-bands

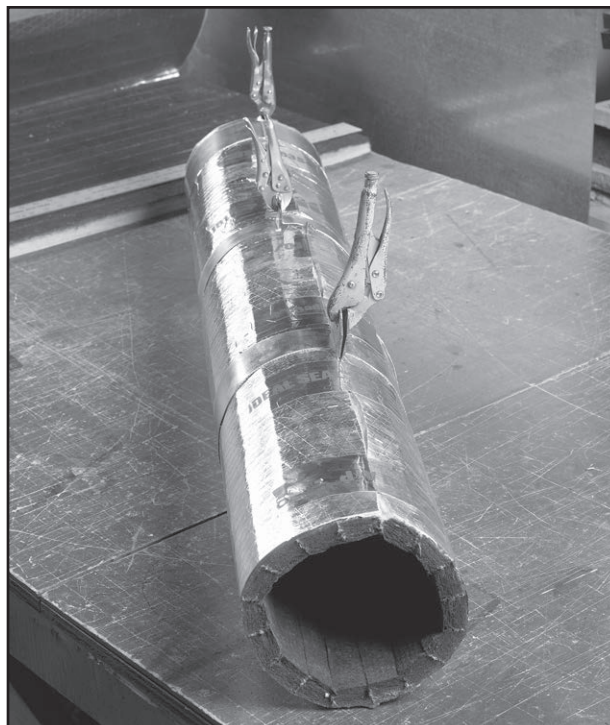

Figure 5-19. All crosstabs in place, ready to remove draw-bands



Figure 5-18. Applying crosstabs

5-9.4. Finish the closed insulation section by applying UL 181A tape down the center of the longitudinal seam. See Figure 5-20. The liner section is now ready to install, by simply sliding into the metal duct section. See Figure 5-21. A slight friction fit is desirable, but should not be so tight that the ends of the insulation are deformed during installation. Make minor adjustments to the stretchout of subsequent sections, as necessary. In the event that insulation sections slide freely in the duct, apply a bead of SuperSeal HV coating around the circumference of the end insulation sections prior to installation.



Figure 5-20. Completed insulation section with longitudinal seam taped



Figure 5-21. Slide insulation section into metal duct

5-10. Securing Spiracoustic Plus® Insulation in Straight Duct

Spiracoustic Plus liners do not normally require pins, adhesive or other types of mechanical securement in straight duct sections. However, there are several applications where fastening may be necessary:

- Spiracoustic Plus liner applications where the insulation slides easily in the duct (loose fit), as with VVSD or VSD sizes.
- In systems where high-velocity fans will be operated before the duct system installation is completed.
- In very large (> 60" ID) duct sections prior to the installation of connection flanges or reinforcement rings.
- In any duct where the round shape will not be retained after installation, such as in special clearance fittings or architectural design applications.
- Vertical runs, or other risers greater than 45° from horizontal.
- Partial liner applications, where Spiracoustic Plus System lining ends and unlined metal continues. The downstream (last) section of liner must be mechanically secured.

5-11. Securing Straight Sections – Vertical Duct or Risers

5-11.1. Mechanical Angle Clips – Install 1" x 1" x 1" long, min. 20 ga. galv. clips to the sheet metal duct, with one of the angle legs of each clip firmly against the downstream butt-edge of the lining. Fasten clips with mechanical fasteners or tack weld. Both ends may require mechanical clips with vertical return air ducts.

5-11.2. Clip Spacing – Place clips around the duct circumference, maximum 12" on center, with a minimum of three clips per liner section. Where the vertical drop exceeds 16 feet, install clips on every other liner section and finish with a row on the end section.

5-11.3. Large Diameter Securement – In addition to the clips described above, vertical duct runs of 60" ID or greater must have mechanical fasteners (weld pins or metal screws with washers) on 24" centers (max.) at the upstream and downstream edges of each liner section. The fasteners should be approximately 3" in from the ends of the liner section.

5-11.4. Alternatively, a continuous 3/4" bead of SuperSeal HV duct liner may be applied to the circumference of the liner section, approximately 3" from each end, prior to installation. The adhesive will substitute for the mechanical fasteners, but does not eliminate the need for clips.

5-12. Fastening Requirements for Negative Pressure Systems

Where negative pressure greater than 0.5" wc exist, or in any supply air duct that may be used for emergency smoke exhaust, JM requires the use of mechanical fasteners to secure Spiracoustic Plus Liner into the air duct. All other techniques and requirements in this guide also apply to all negative pressure applications, regardless of pressure or velocity. The minimum requirements for fastening are described below:

- The systems must be completely sealed against leakage to prevent airflow between the duct shell and insulation FSK backing.
- Care should be taken during installation to cut the insulation sections to the tight end of the recommended size range.
- Any leading edge of the insulation exposed to airflow by normal or emergency system operation must have a metal nosing.
- Any insulation that will be exposed to negative pressure must be secured with mechanical fasteners, 3" in from the ends of each insulation section and one row centered between the ends. The fasteners should be spaced evenly around the circumference of the duct, with the spacing not to exceed 16".

Section 6 – Fitting Considerations

6-1. Introduction to Fittings

Spiracoustic Plus System products can be used in nearly all types and sizes of air distribution fittings. In common fittings, particularly of straight-through (nonreducing) design, significant shop labor savings are attainable in comparison to double-wall metal fittings.

For projects with multiple common fittings, patterns can be made to speed up the application of Spiracoustic Plus products. If regular repeat work is anticipated, such as in a spiral fabrication shop, templates can be made to improve efficiency. Customized band saw and notching equipment is also available to simplify and speed up liner installation in fittings.

The following are general fitting guidelines:

- Unlike typical straight duct, adhesive and pins may be required to secure individual panels of insulation.
- Straight-through fittings can be lined simply, requiring only careful cutting to avoid gaps.
- Tapered fittings require liner layout and cutting. Modifications to the metal layout, particularly in taper or reducer section length, can reduce lining labor requirements.
- Gaps or voids in the insulation must be repaired before duct system assembly! This is typically done using SuperSeal HV coating on gaps less than 1/2" wide, or a combination of SuperSeal HV Coating and patch material for larger gaps.
- The thickness and density of the liner insulation mandates that fitting liner sections be carefully cut to minimize internal gaps. In many fittings, variable-angle cuts will be required. A little extra care when cutting dramatically reduces the need for filler or repair.
- All exposed internal fabrication cuts and section joint edges must be coated with SuperSeal Edge Treatment, or SuperSeal HV coating. Note that the factory kerfs do not normally require additional sealing, unless damage has occurred during shipping or installation.

6-2. Liner Securement Notes

It is the installer's responsibility to ensure that Spiracoustic Plus liner is secured in the duct sections and fittings. Although glue or mechanical fasteners are not normally required where full sections of insulation are utilized, fastening is required when the lining fit is loose or where small liner sections are used, such as in fittings.

Small (less than 2 sq. ft.) or short liner sections, or any liner section where the contractor is concerned about a secure fit, must be fixed to sheet metal parts with approved liner adhesive and/or mechanical fasteners.

The following notes apply:

6-2.1. Space pins at even intervals around the circumference at approximately 16" (max.) intervals, in a single row (perpendicular to the duct length). Pins should be installed in a factory-made kerf, with no fewer than four pins per row.

6-2.2. Rows of pins, as described above (6-2.1), shall be placed approximately 3" in from each end of the insulation section to be secured.

6-2.3. As an alternative, or in addition to pins, a 4" wide zig-zag band of SuperSeal HV coating or approved water-based duct liner adhesive between the metal duct wall and the insulation facing may be used to secure the liner, using a single band of adhesive approximately 3" in from each end of the insulation section.

6-2.4. Pins should be sized for 1/16" or less compression when installed; the high density of Spiracoustic Plus duct liner may cause shorter pins to fail.

Note

The foil facing on Spiracoustic Plus duct liner may interfere with the arc ground of pin welds. When the pin strikes the metal duct shell, press down and rotate the pin approximately one-quarter turn to penetrate the liner facing with the point of the pin. Impact pins ("Bangers") are also acceptable when installed properly.

6-3. SuperSeal® Application Notes

Johns Manville SuperSeal products are designed to replace, repair or augment the factory-applied airstream coating. To maintain the integrity and performance of Spiracoustic Plus product coatings, apply SuperSeal coatings as described in this guide.

- SuperSeal products are water-based and **MUST BE PROTECTED FROM FREEZING!**
- Where sub-freezing jobsite conditions exist, warm the application surface to at least 40°F prior to coating or repairing with SuperSeal products.
- Maintain minimum 40°F temperature for at least two hours after application to allow the product to properly cure.
- SuperSeal edge treatment must be stirred thoroughly before application, preferably with a mixing attachment on a drill motor.
- Use caution with electrical resistance or other drum heating wraps. Excessive heat applied to the drum can cause the solids to settle out of suspension or cause a partial cure.
- For spray application of SuperSeal edge treatment, treat the coating as a water-base acrylic paint, with no abrasive particulates or corrosives. Special spray equipment is not required for application. However, for best results, use an airless nozzle (rather than a pressurized spray) with an orifice of 0.026 (a range of 0.022–0.030 acceptable). Teflon seals and packings will give better long-term service, if available.
- Equipment should be cleaned immediately after use. Warm, soapy water will provide good results.
- SuperSeal products will stain cloth, upholstery and other porous surfaces; appropriate precautions should be taken to prevent spills. In the event of spills, clean up immediately with warm, soapy water.

Note

Johns Manville makes no claim regarding thermal resistance characteristics of SuperSeal HV coating or any other filler, liner adhesive or caulking-type compounds. Where thermal performance is critical, the liner insulation must be carefully installed to eliminate voids or gaps.

Section 7 – Multiple Gore Elbows

Gore elbows are easily lined using JM Spiracoustic Plus insulations. To ensure accurate fittings and good insulation coverage, JM recommends using patterns with quarter marks. Without quarter marks, misalignment can cause gaps between liner sections.

Note that this guide does not specifically address stamped or other manufactured radius elbows. Many types of radiused elbows can be lined with short throat radius sections of Spiracoustic Plus liner. However, for best results, miter cuts should be made by band saw or with a miter box. Contact your Johns Manville representative for information on band saw fitting systems.

As shown in Figure 7-1, Spiracoustic Plus board has been installed in four of the five gores of the 90° elbow. No pins or liner-to-duct adhesive have been used to secure the insulation “segments.” A bead of SuperSeal HV coating will be applied to the butt end of the insulation segment before installing the end gore.

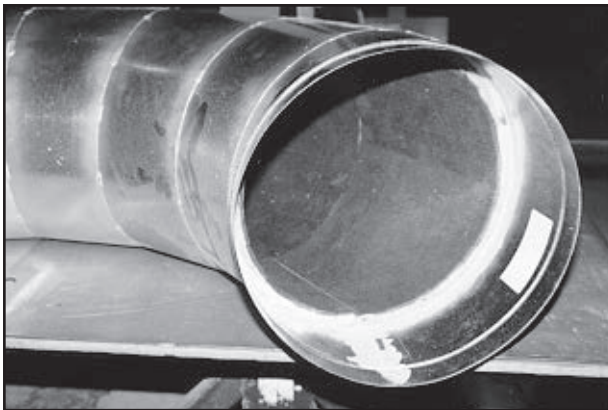

Figure 7-1. Spiracoustic Plus in 90° elbow

Several options for cutting liner segments are described in this Guide; however, use of a clamping pattern, as illustrated in the following example, works very well with small-to-medium duct diameters.

7-1. Method One: Sheet Metal “Draw-band” Pattern

This method produces consistent liner gore sections with minimal gaps. Tools required include an extra sheet metal end gore pattern (as outlined below), locking pliers and a Johns Manville insulation knife.

7-1.1. Roll the end gore pattern to the required diameter and spot weld short sections of angle to each side of the longitudinal seam (see Figure 7-2). Note that the seam should be on the side of the gore, halfway between the heel and throat marks. As shown, the draw-band gore pattern is attached to a formed round liner segment. Note the angle tacked in place to support locking pliers.

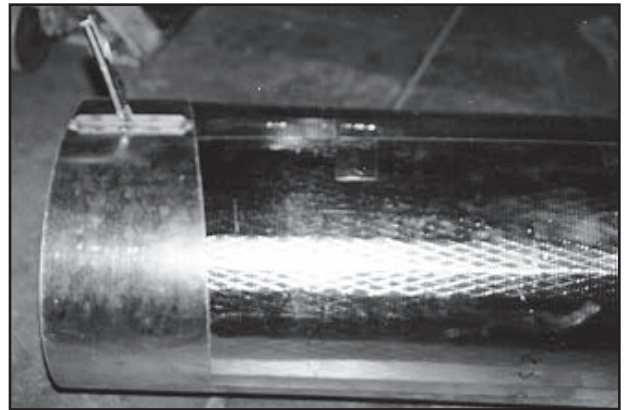

Figure 7-2. End gore pattern

7-1.2. As an alternative to the step in 7-1.1, produce the end gore pattern with extra straight length on each side of the longitudinal seam and form an angle on each seam prior to roll forming.

7-1.3. Cut a full section of Spiracoustic Plus liner to the correct circumference (or use preformed Spiracoustic Plus) to fit tightly inside the metal fitting. Figure 7-3 shows Spiracoustic Plus liner formed into a full insulation segment prior to cutting elbow gores. When used for fittings, the section should be marked with half lines (opposite seam) on FSK facing for pattern or assembly alignment.

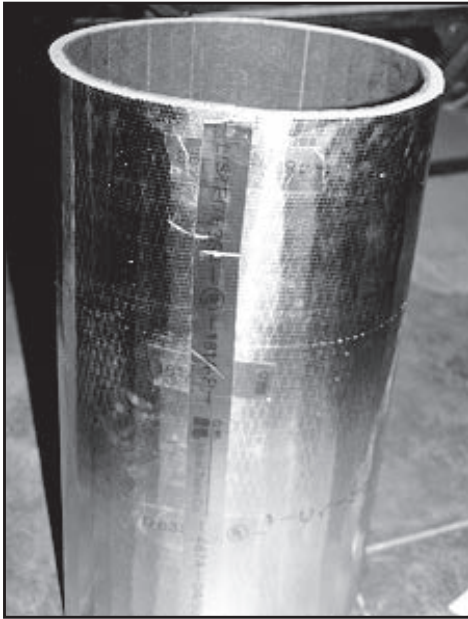

Figure 7-3. Spiracoustic Plus liner

Note

Check fitting for proper circumference, as fittings are typically made smaller in diameter than straight spiral duct.

7-1.4. Before forming, mark a centerline on the exterior FSK facing of the liner section. After forming into the round shape and taping, this mark will be opposite the liner section seam and will provide a “half” mark.

7-1.5. Place the sheet metal gore pattern around the Spiracoustic Plus liner section, using care to align the pattern seam with the half mark (or seam) on the liner section. Draw the pattern tight and clamp in place.

7-1.6. Using the pattern as a guide, cut the liner section along the miter line. Take care to keep the knife on the correct plane (or miter angle) so that the adjacent gore ends will match as closely as possible.

In Figure 7-4, note the angle of the insulation knife along the miter cut. Attention to the cut angle will minimize internal gaps and reduce the need for SuperSeal filler. Figure 7-5 shows a closeup of the draw-band pattern clamp. Note the alignment with tape insulation seam. Without compression from the clamp, the pattern will



Figure 7-4. Cut liner with insulation knife

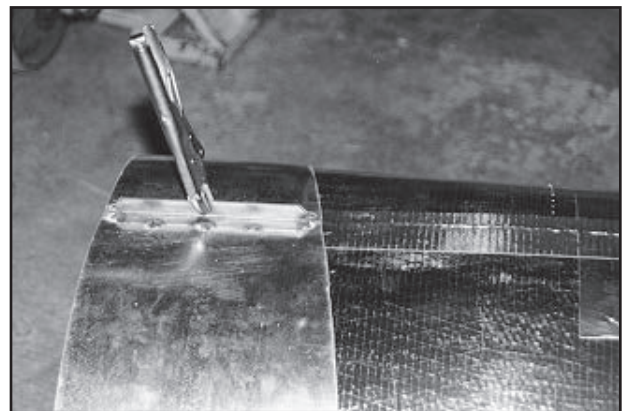

Figure 7-5. Draw-band pattern clamp

shift when cutting the miter. This tendency makes it impractical to use the actual metal gore (without clamping) as a pattern.

Note

For best results, make a shallow guide cut through the FSK facing before cutting through the full insulation thickness.

Figure 7-6 shows the finished gore insulation section with pattern clamped in place. Note the consistent miter angle of the cut. Figure 7-7 shows the Spiracoustic Plus duct liner end gore segment ready for installation.

7-1.7. As each cut is completed, shift the pattern to produce the number of gores required. End gore lengths may differ from center gores.

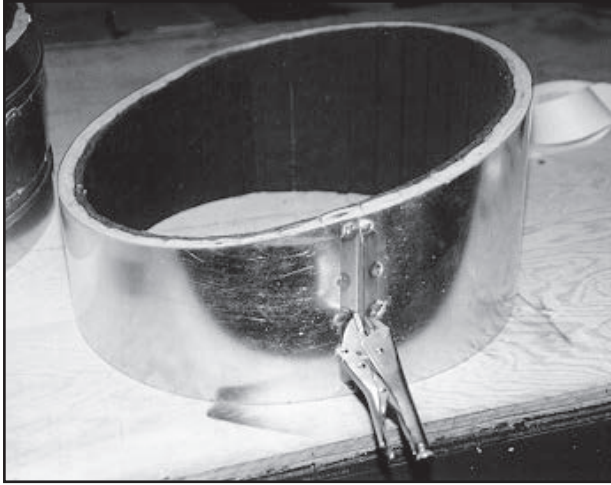

Figure 7-6. Finished gore insulation section

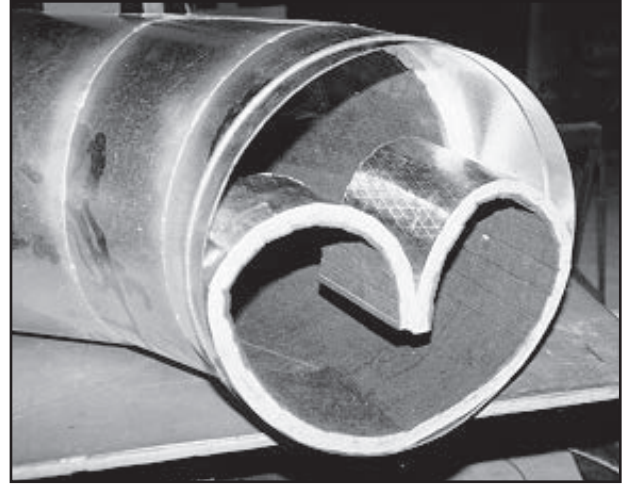

Figure 7-8. Folded gore section in ell

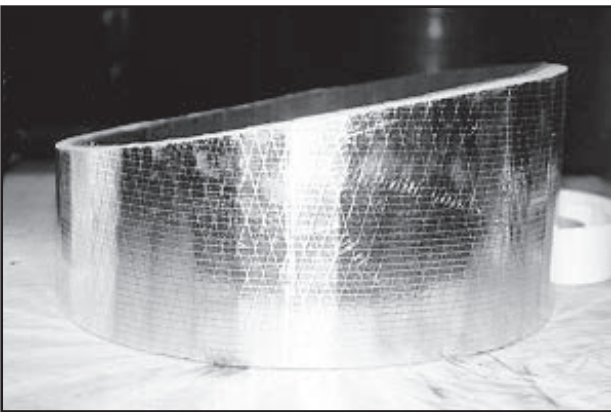

Figure 7-7. Gore section ready to install

7-1.8. Take care to ensure heel and throat dimensions match the sheet metal elbow. For best results, insert the insulation gores into the assembled metal fitting as they are cut to check for proper fit.

7-1.9. As shown in Figure 7-8, Spiracoustic Plus LD & SD duct liner end gore segments are collapsed inward for installation. VVSD and VSD gores slip in. Align seam or half mark with elbow quarter marks. Elbows with short throat radii may require pinning and/or adhesive application to secure end gores. SuperSeal HV coating is not shown in this photo, but is normally applied before segment is installed.

Finished Spiracoustic Plus lining is shown in Figure 7-9, after the last gore is installed. Note that insulation is flush with fitting end. Figure 7-10 is a closeup view of finished Spiracoustic Plus duct liner segment installation. It shows the tight fit within the metal fitting, as well as the close fit of the insulation sections. Careless cuts would require extra SuperSeal HV coating or possible replacement of some insulation gore segments.

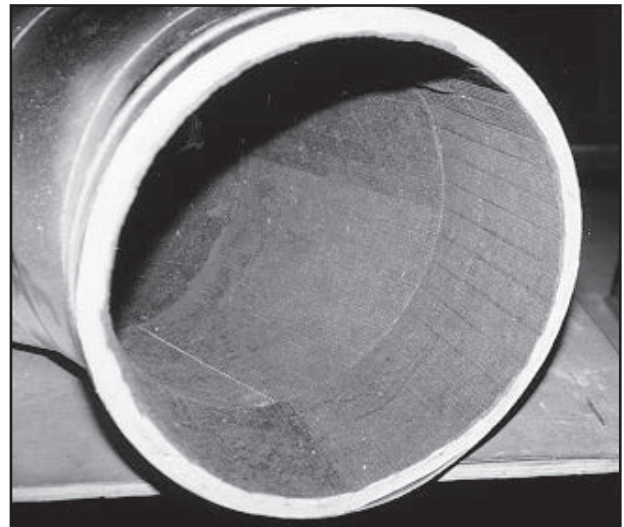

Figure 7-9. Gore section expanded

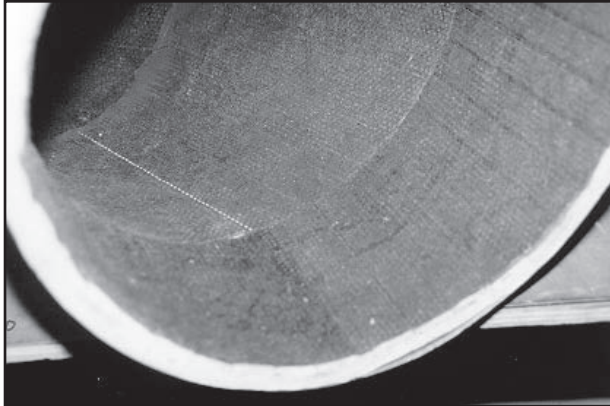

Figure 7-10. Finished gore section

7-1.10. The Spiracoustic Plus duct liner fitting shown in Figure 7-11 is ready for installation. Gore segment seams have been buttered with SuperSeal HV coating. Edge coating, as shown, may be done in the shop to guard against shipping or jobsite damage. Note that factory kerfs do not require additional coating unless damaged.

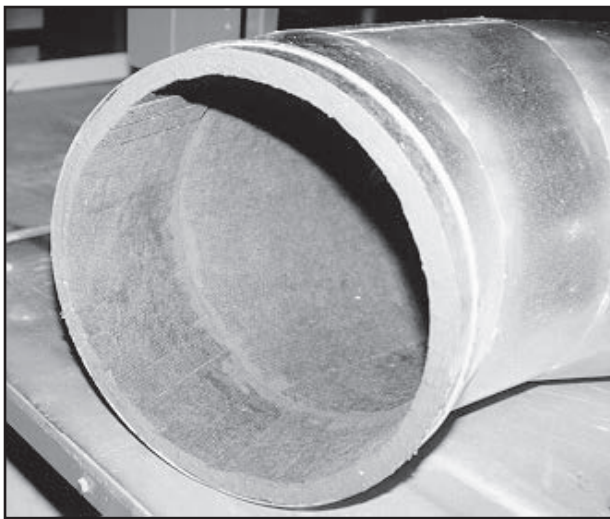

Figure 7-11. Fitting ready to install

7-2. Method Two: Sheet Metal Elbow Gore (formed and seamed) as Pattern

A rolled and seamed elbow gore can be used to cut Spiracoustic Plus liner gore sections, as outlined in method one. However, due to the tight interference fit, it is difficult to accurately align the finished sheet metal gore around a formed liner section that has been cut to the correct circumference.

The second problem is “drift” of the pattern while cutting. In spite of the interference fit, it is very awkward to make cuts and maintain pattern alignment, particularly on short-end gores.

In spite of these drawbacks, this is often the first method a new Spiracoustic Plus duct liner user will try, simply because it’s natural to use the materials at hand.

7-3. Method Three: Sheet Metal Pattern, Cut in the Flat

A flat pattern can be used to cut Spiracoustic Plus liner board gores prior to rolling and taping. This “visual” method makes alignment and cutting fairly simple. However, since it is virtually impossible to cut the Spiracoustic Plus duct liner with the correct intersecting angle for the miter, the abutting gore joints will require more SuperSeal HV filler in the throat of the fitting. For a clean fit, additional trimming may also be required at the heel.

Flat patterns work best with very large elbows, where it is impractical to handle preformed insulation sections and draw-band patterns. Flat patterns are also used where gores are so large that multiple insulation segments are required for a single gore.

7-3.1. Cut a section of Spiracoustic Plus duct liner to the correct circumference for the elbow to be lined.

7-3.2. Working on a bench or clean floor area, place the end gore sheet metal pattern on the pre-cut liner board with the straight (end) side aligned with the butt edge.

7-3.3. Using the curved edge (miter) of the sheet metal pattern as cutting guide, cut through the liner, taking care to keep the pattern securely located. The first curved (miter) cut will free the end gore and leave the first cut of the next gore, which will normally be a center gore.

7-3.4. Mark the liner with the required throat and heel dimensions for the next gore, or notch the pattern to align with the center gore length.

Note

Center and end gores almost always have different throat lengths. When cutting, take care not to confuse the dimensions.

7-3.5. Rotate or flip the pattern as required to make the required number of gores, taking care to not let the pattern slip while cutting. Make sure that the heel and throat dimensions match the finished metal elbow.

7-4. Method Four: Miter Box/Band Saw Cutting

For small diameter elbows, particularly where Spiracoustic Plus VVSD or VSD duct liner will be used, the manufacture or purchase of a “miter box” that is adjustable to the proper miter angles can be easily justified.

For any application that requires a large number of small diameter elbows (up to approximately 28” ID), a round band saw can increase productivity and produce a product that will have accurate and clean miter cuts.

7-5. General Elbow Notes

7-5.1. The most important elements of liner fit in elbows are:

- Minimal gaps between liner sections.
- Liner end gores are held securely by circumference fit, and/or pins and adhesives.
- All exposed fiberglass edges are buttered and/or filled with SuperSeal coating.

7-5.2. Metal practice often calls for the “eyeball” lining up of elbow gores prior to welding. For fittings that will be lined, consider adding tick marks or scribe lines for quarters. The more accurate the metal alignment, the better the liner will fit.

7-5.3. Run a bead of SuperSeal HV coating around each gore end prior to assembly to fill small gaps and help secure individual gore sections.

7-5.4. Where pins and/or adhesives are required, refer to Liner Securement Notes in paragraph 6-2.

Section 8 – Reducers

Spiral HVAC duct design typically uses short reducers with a steep taper angle. Normal shop practice is for a minimum reducer length of 4" and a maximum of 12," plus the collar lengths.

While reducers built to this formula can be lined with Spiracoustic Plus System products, adding length to the taper section eases liner cutting and installation. The added length will also provide a better finished appearance. JM recommends a minimum length of 10" (plus collars) for lined reducers. Also, overall collar length (slip collar plus straight) should be a minimum of 4," with 6" or more preferred.

Note

Typical short length reducers can be lined using insulation segments cut from Spiracoustic Plus fitting fab board, while longer length reducers (with taper section lengths greater than 10") can frequently be cut from the standard Spiracoustic Plus duct liner. Longer lined taper sections and straights usually require fewer mechanical fasteners and less adhesive.

8-1. Method One: Concentric Conical Reducers 8" or Longer

8-1.1. On the bench, cut a flat section of Spiracoustic Plus liner to fit the circumference of the larger diameter of the fitting.

8-1.2. This insulation section will line the large-end straight section and the taper section of the fitting. Cut the length of the insulation to match the required straight length. Referring to Figure 8-1, calculate the straight length by adding the large-end straight lap, the large-end straight and the true length of the taper, or:
Liner section length = SL + S + TL

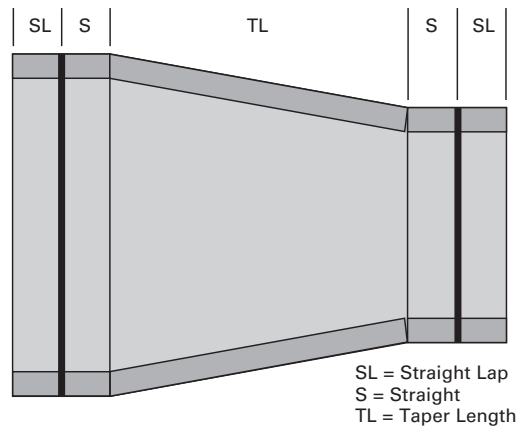

Figure 8-1. Concentric conical reducer

8-1.3. Along one edge of the insulation stretchout, mark vee-shaped cut lines centered on factory kerfs and spaced equal distance apart. See Figure 8-2. The cuts will be approximately $1/2 \pi$ (1.57" or about $1 \frac{9}{16}$ ") wide at the mouth of the vee and will extend through the true length of the taper section. To determine the number of "wedges" required, use this formula:

(Large end diameter - small end diameter) / size change, in inches

Two 1.57" wedges are required for each inch of size change.

Example:

36" to 30" reducer changes by 6," and requires 12 wedge cuts
28" to 24" changes by 4," and requires 8 wedge cuts.

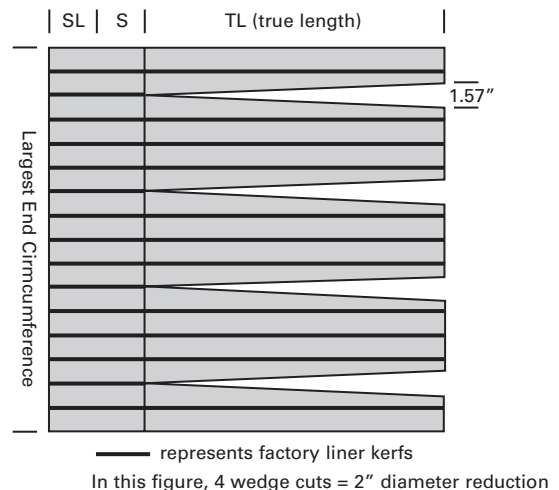

Figure 8-2. Vee-shaped cut lines

The preferred method of lining concentric reducers with Spiracoustic Plus duct liner, as described in paragraph 8-1, requires a minimum taper length of 8". Note in Figure 8-3 the marking of the required vee notches that will reduce the diameter to fit the small end.

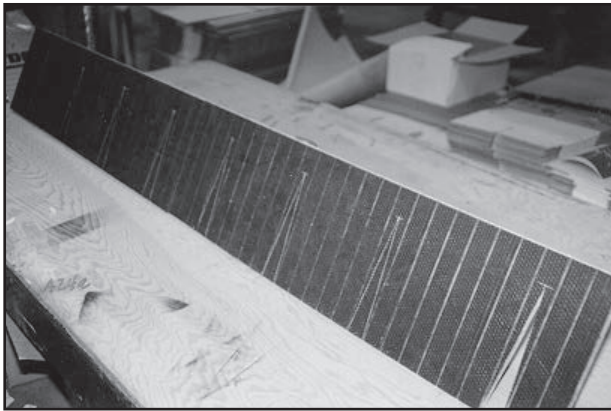

Figure 8-3. Marked "vee" notches

Note

Using the 1.57" wedge cut width will give good, repeatable results with typical length reducers. Larger cuts, such as 3.15", can result in distortion of the liner section and require extra filler and/or pins to correct the distortion and secure the liner in place. Larger wedge cut widths are suitable only where reducer taper section length is greater than 18" and the diameter is greater than 40".

The closeup photo in Figure 8-4 illustrates notch detail, the removed "wedge" and use of white crayon for marking on black coating. Notch length matches true length of fitting taper section.

8-1.4. Complete all cuts and remove the wedge sections.

8-1.5. Form and tape the Spiracoustic Plus liner section. Pull the cuts together and tape, either individually or using a "draw-band" around the insulation.

Figure 8-5 shows the Spiracoustic Plus taper liner insert with seam closed to form round section.

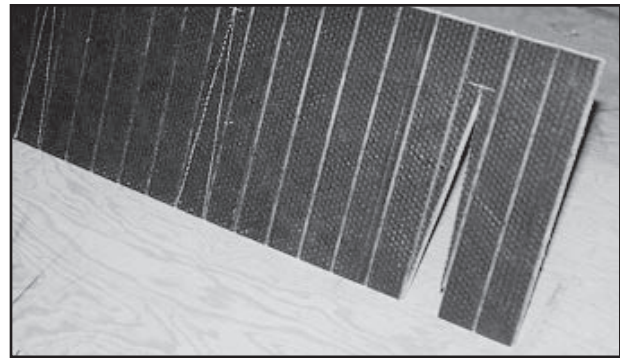

Figure 8-4. Closeup of "vee" notches

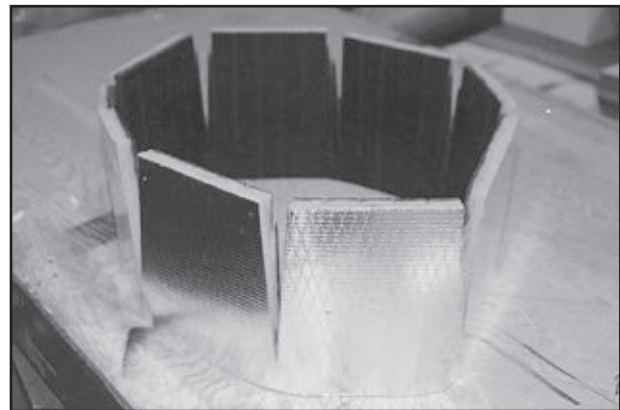

Figure 8-5. Taper insert with seam closed

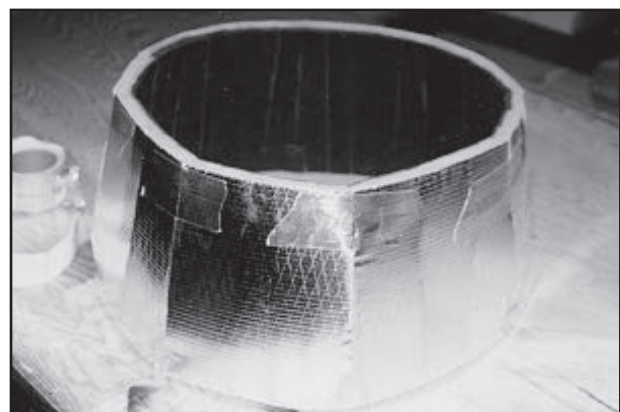

Figure 8-6. Taper insert with wedge cuts closed

Figure 8-6 shows the Spiracoustic Plus taper liner insert with wedge cuts pulled together and taped. Notch seams are not always taped prior to installation. Pressure from tapered fitting body keeps internal cuts firmly closed after installation.

Figure 8-7 Shows the liner section inserted into the metal shell from the large end to butt against small-end collar and metal shell. In most applications, SuperSeal HV coating, pins or a combination of the two will be required to secure the liner.



Figure 8-7. Taper insert in duct

8-1.6. After wedge cuts and seams are closed and taped, insert the liner section into the large end of the metal shell. The small-end collar may be added after or before the taper section installation. Note in Figure 8-8, the smooth interior and good fit, with no gaps or wrinkles.



Figure 8-8. Finished taper section

8-1.7. Apply SuperSeal filler and pins as required. Note that pins and/or adhesive will be necessary to secure collars in this fitting application.

8-2. Method Two: Multiple Segment Reducers

Conical reducers can also be lined using individual insulation segments formed to the reducer pattern. The trapezoid-shaped segments must be cut from flat sheets of Spiracoustic Plus Fitting Fab Board. The sizes of the segments are determined from the sheet metal fitting shell dimensions, as described by the example in paragraph 8-2.1.

To simplify calculations, JM recommends standardizing the large end segment width at 3.0625" (3 1/16") for all reducers with the large-end greater than 24" inside diameter. Why that constant? It represents π (3.1416) minus a segment space allowance of .079 (3/32") .

Note

While decimal fractions are shown in this section, they should be treated as approximations. Fiberglass insulation is more dimensionally forgiving than metal!

8-2.1. Fitting Example: Using multiple liner segments, line the fitting shown in Figure 8-9.

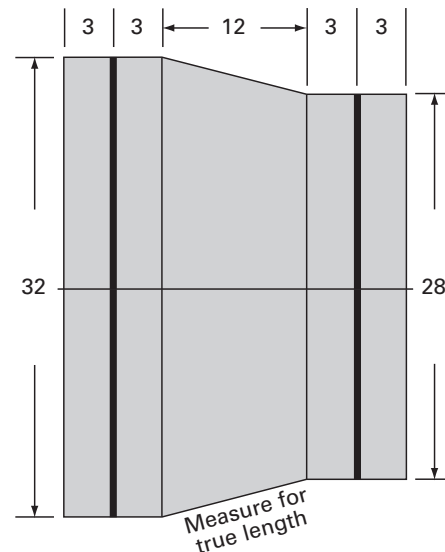

Figure 8-9. Multiple segment reducer

8-2.2. Establish the length of the segments by determining the true length of the taper slope. In this example, it is calculated by finding the hypotenuse of a right triangle with a base of 12" and a height of 2"; which gives a hypotenuse of 12.165" (approximately 12-3/16"). Calculations can be bypassed by measuring the true length directly from the metal fitting shell.

8-2.3. Determine the liner segments needed. Using the recommended large-end standard segment width (see paragraph 8-3), the number of segments required equals the diameter of the large end in inches, or 32 segments.

Note

When using the recommended standard large-end spacing of 3.0625," the number of segments required will always equal the large-end diameter in inches.

8-2.4. Determine the width of the small end of the liner segment shown in Figure 8-10. In this example, the number is 2.67" (2 11/16"). The steps of calculation are:

- a) Subtract the large diameter from the small diameter
- b) Multiply the result by π to find the difference in circumference
 $4" \times 3.1416 = 12.567"$
- c) Divide the result (12.567," in this example) by total segments to determine the circumference difference by segment
 $12.567" / 32 = 0.393"$
- d) Subtract the result from the segment large-end width to get small-end width, or
 $3.0625" - 0.393" = 2.67" (2 \frac{11}{16}")$

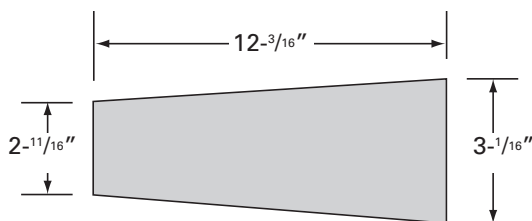

Figure 8-10. Segment Dimensions

8-2.5. Using a flat pattern (or actual flat metal body) of the taper as a guide, tape the segments (FSK facing up) together as shown in Figure 8-11, with a gap of approximately 3/32" between the segments. A piece of cardboard can be used as a spacer. Use short tape tabs to secure the sections prior to applying UL 181A tape to the segment seams.

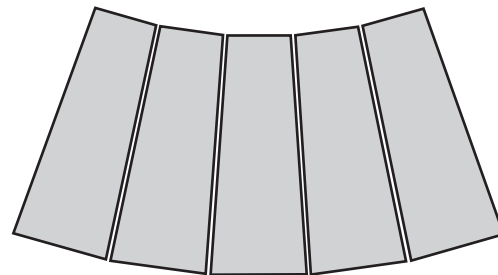

Figure 8-11. Segment Assembly

8-2.6. Trial-fit the insulation into the sheet metal reducer shell. Adjust the stretchout as required before taping the final liner seam.

8-2.7. Cut and form collars for both straight ends from Spiracoustic Plus duct liner. Before installing the end collars, butter the abutting edges with SuperSeal HV coating. Pins are required to secure the liner in this type of fitting. Refer to paragraph 6-2.

8-3. Method Three: Flat Pattern Layout

Concentric and eccentric reducers with large end inside diameters greater than 24" can be lined using this method. A flat pattern of the taper section is used with Spiracoustic Plus Fitting Fab Board to provide good installed liner appearance.

The flat pattern method allows Spiracoustic Plus System products to be used in unusual fittings such as the eccentric reducer shown on Figure 8-12. This fitting changes diameter 4" over a 4" length, and is flat on one side. For best results with Spiracoustic Plus, Johns Manville recommends using the longest practical taper length.



Figure 8-12. Eccentric reducer

This flat-patterns technique is not as "flexible" as the segment method (described in paragraph 8-2), but the process is similar. Flat pattern layout produces excellent results with reasonable installer care and allows lining of offset fitting.

8-3.1. Produce a pattern of the taper section, or use the actual flat sheet metal taper blank. Take care to accommodate any allowances for seams, laps, etc. Final circumference may also require adjustment prior to liner installation into the formed metal fitting shell.

8-3.2. Place the pattern securely on a sheet of Spiracoustic Plus Fitting Fab Board (airstream coating side up). Cut carefully around the pattern to produce the insulation blank. For best results, use a sharp knife to score through the coating, then follow with a final cut through both the fiberglass and FSK facing. Figure 8-13 shows the liner blank cut from Spiracoustic Plus fitting fab board using metal blank as a pattern. Vee groove guide marks are shown on the coated airstream surface.

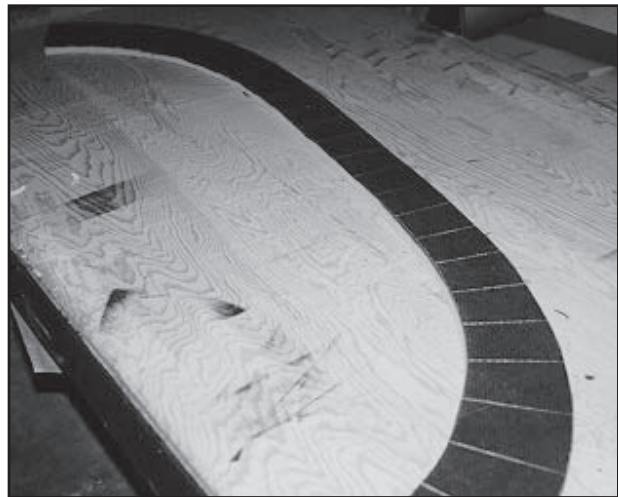

Figure 8-13. Spiracoustic Plus Fitting Fab Board

8-3.3. With the insulation blank on the bench, coated airstream surface up, make a series of marks along the large end of the blanks at approximately $3 \frac{3}{16}$ " (π) intervals.

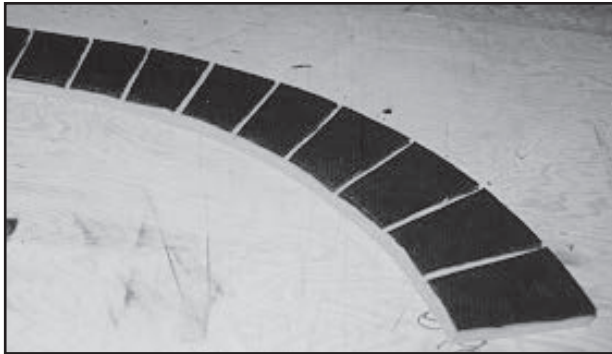

Figure 8-14. Radial grooves

8-3.4. Using a 15° V-groove hand tool (Amcraft “White” 15° tool), cut radial grooves as shown in Figure 8-14. The V-grooves should be 3/4” to 7/8” deep and should not score the FSK facing. It is helpful to mark the radial grooves prior to cutting, particularly with eccentric reducer blanks.

Factory-kerfed Spiracoustic Plus duct liner was not used for this application because the extreme angles at the end of the insulation blank would result in excessive compression of the factory kerfs, possibly leading to delamination of the fibreglass.

Note

There is a strong temptation to make “freehand cuts” rather than measuring and marking. While an experienced fabricator can usually obtain satisfactory results on large reducers without marking the insulation blanks, “freehand cuts” generally increase scrap and SuperSeal HV coating usage at a rate that offsets any labor savings.

Figure 8-15 shows the formed and taped insulation insert for the taper section. The collars (not shown) are also cut from Spiracoustic Plus duct liner.

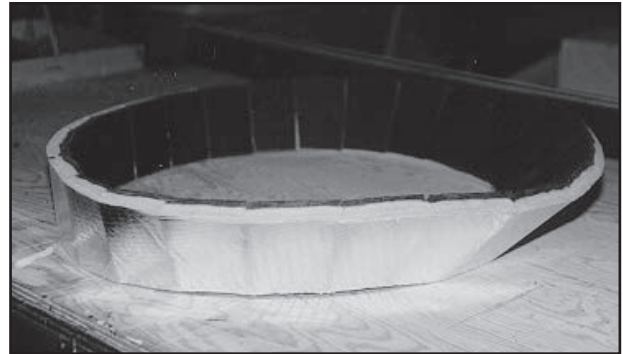

Figure 8-15. Formed and taped insert

8-3.5. Trial-fit the finished insulation blank into the sheet metal reducer shell. Make circumference adjustments as required before taping the final liner seam. Trimming, shown in Figure 8-16, is necessary for a tight fit with minimal gaps. The tapered liner blank must be trimmed to butt against the straight collar without excessive gaps. Note that lengthening the metal taper shell reduces or eliminates the need to trim. Apply SuperSeal HV coating to any rough or damaged grooves prior to final taping.

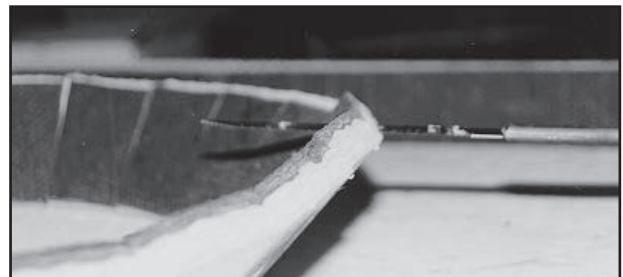

Figure 8-16. Trimming the insert

8-3.6. Cut and form straight collars for both ends from Spiracoustic Plus duct liner. Before installing insulation sections, butter the abutting edges with SuperSeal HV coating. Pins are required to secure the liner in this type of fitting (refer to paragraph 6-2).

Figure 8-17 shows the tapered liner section installed in the shell. For clarity, SuperSeal HV coating was not applied in this example. The small diameter collar, shown in Figure 8-18, is installed in the fitting shell. Note the obvious gap left by this cutting method. Adding length to the tapered section of the fitting would reduce the angles and the resulting gap significantly.



Figure 8-17. Tapered section installed

The gap that is evident in Figure 8-19 could also have been reduced (without added taper length) by producing a metal pattern with 1" additional length on the small end to allow trimming. A pattern is useful when a number of identical fittings are involved. It is also possible to "eyeball adjust" and add length to the small diameter side of the liner blank while cutting. Note that the final trim in either case is made more difficult by the need to remove FSK as well as fiberglass. Figure 8-20 shows all insulation sections installed in metal shell.

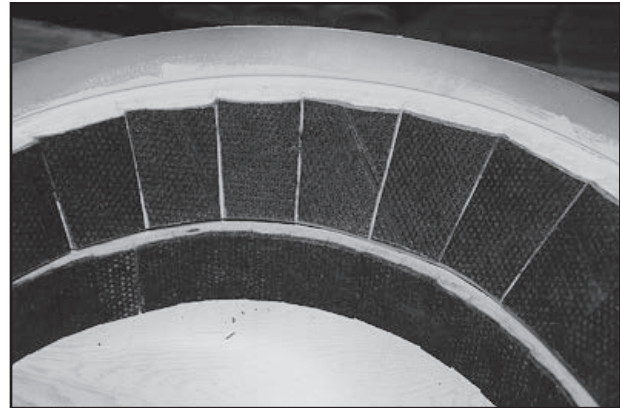

Figure 8-18. Small diameter collar installed

Short Spiracoustic Plus collar sections require pins per JM installation recommendations in paragraph 6-2. Figure 8-21 shows SuperSeal HV coating liberally buttered on the seams, with extra care taken to fill the gap between the tapered insulation section and the small end collar.

The finished Spiracoustic Plus System liner application, Figure 8-22, provides a neat appearance and needs only edge-coating before installation. When SuperSeal HV coating is used to fill deep or wide gaps, as was the case in this example, additional drying time is required for a complete cure and some shrinkage may occur. Again, note that lengthening the taper section of a reducer improves virtually all aspects of this type of fitting.

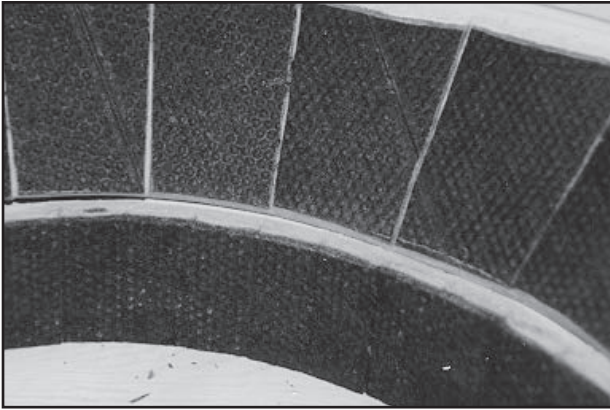

Figure 8-19. Large gap between taper and collar

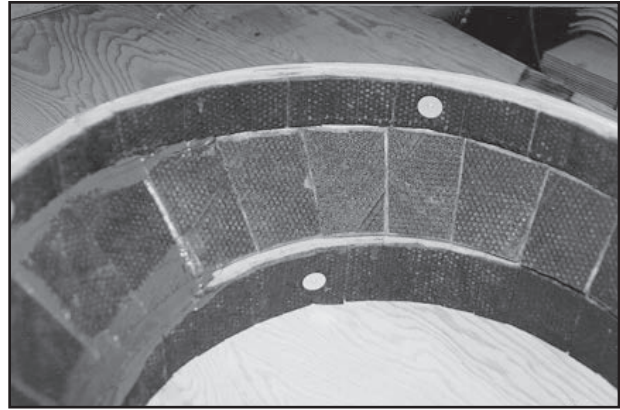

Figure 8-21. Pinned collar sections



Figure 8-20. All sections installed

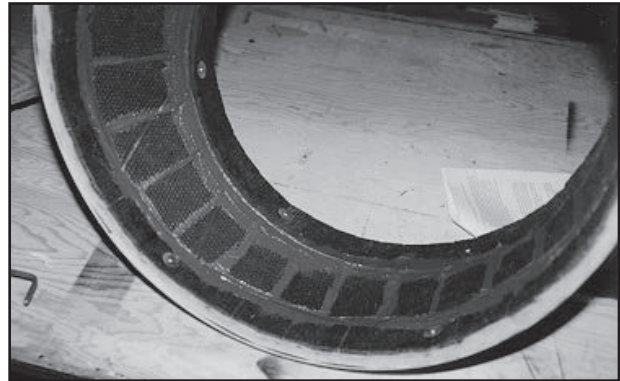

Figure 8-22. Finished liner

Section 9 – Branch Fittings/Tap-Ins

9-1. General Description

This section outlines several methods for applying Spiracoustic Plus duct liner to branch fittings. There are many variations of this type of fitting, with almost as many different descriptive names.

In this section, we are referring to:

- Straight-through fitting bodies with straight branch taps or take-offs.
- Straight taps intersecting the body at any angle, but typically between 30° and 90°.
- Straight-through fitting bodies with conical tee laterals.
- Fittings with taps intersecting the body on center or tangentially.
- Fittings with taps of equal or smaller size than the body.
- Straight rectangular taps serving as duct take-offs or diffuser supports.

A single diameter straight or angle tap on a single diameter straight body is the simplest of this type of fitting.

9-2. Liner Support Requirement for Branch Cut-Outs

Branch fittings and tap-ins require removal of Spiracoustic Plus duct liner in the opening created by the tap. Cuts longer than 12" overall (measured along the duct length) must be supported by mechanical fasteners, channels, or Z-clips to retain the liner integrity.

Securement Options:

- Mechanical fasteners must be spaced approximately 12" (max.) on center around the tap-in opening, 2" (min.) in measured from the cut. Fasteners may be approved liner pins or screws through washers against the insulation airstream.

- If conditions permit the use of Z-clips, the clips must be spaced approximately 12" (max.) on center and overlap the liner surface by the thickness of the liner.
- For rectangular taps, channel or Z-bar with a minimum liner surface overlap equal to the thickness of the liner is preferred over pins or mechanical fasteners.

9-3. Straight Take-Offs

9-3.1. Cut a section of Spiracoustic Plus duct liner to fit the diameter and/or circumference of the branch portion of the fitting, allowing approximately 6" extra material for the liner section length. A large-diameter tap on a large-diameter body may require extra material length to fit properly.

9-3.2. Spiracoustic Plus liner should be formed into a round liner segment and taped at the seam before proceeding. Figure 9-1 shows Spiracoustic Plus duct liner applied to a non-reducing angled tap on a straight-through body.

9-3.3. Install the liner section into the branch of the assembled fitting, flush with straight end. The round liner section must extend past the intersection with the tee body.



Figure 9-1. Angled tap on straight-through body

9-3.4. Using the fitting body (also called trunk or barrel) as a guide, position the knife blade against the inside diameter of the body and trim the excess liner material from the tap liner section, taking care to cut the liner with the correct angle/contour. This is most readily accomplished by holding the knife blade flush with inner surface of the body of the tee.

9-3.5. Cut and install a section of Spiracoustic Plus liner to fit the main body of the fitting. The length should equal the overall fitting body length, end to end.

9-3.6. Using the branch, with liner in place as a guide for the knife blade, cut the opening in the body liner section. Use care not to cut into the branch liner material as the cut is made.

9-3.7. Carefully butter all fabrication cuts with SuperSeal HV coating. The airflow characteristics and steep cut angles of taps make this step critical.

Note

A long-bladed, sharp knife is preferred for cutting branch fitting intersections. Care must be taken not to delaminate the “blocks” of insulation when penetrating the interior of the liner from the exterior (FSK facing) side.

Using standard, formed liner sections fabricated from Spiracoustic Plus duct liner, the tap was lined and trimmed first, followed by the body insulation. See Figure 9-2. Allow sufficient tap length for trimming. Please refer to Figures 9-6 and 9-7 for liner intersection trimming details.

9-4. Conical Tees

Conical tee practice varies by shop. For common industry practices please refer to the SMACNA HVAC Duct Construction Manual.

This type fitting can be made from flat Spiracoustic Plus Fitting Fab Board, using a reducer a pattern. Before starting liner layout, verify slope and length.

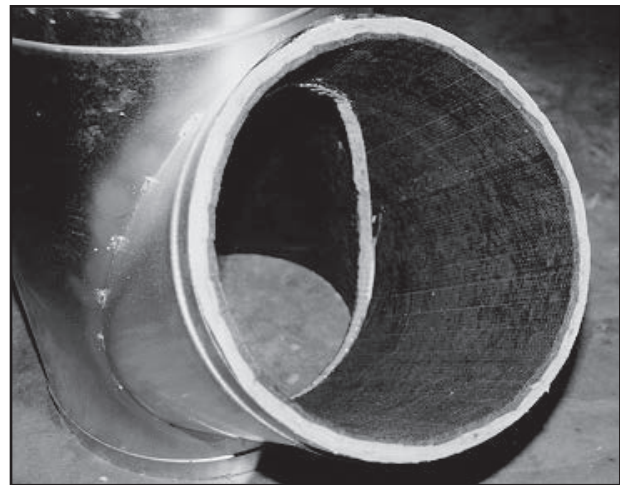

Figure 9-2. Tap lined and trimmed

9-5. Conical Tee Method One: Vee Notches (Centerline)

The following outline assumes that the conical tee slopes 1” on each side, or 2” total.

9-5.1. On the bench, cut a section of Spiracoustic Plus duct liner with a circumference sized to fit a diameter 4” larger than the branch collar size. For length, allow 2” straight, plus at least twice the conical tee length (measure).

9-5.2. Along the collar circumference edge, mark cut lines for 8 V-shaped wedges, centered on factory kerfs, and spaced equal distance apart. The cuts will be approximately $1/2 \pi$, which is about 1.57” (1 9/16”) and twice the length of the conical reducer taper.

Figure 9-3 shows Spiracoustic Plus duct liner on a bench with V-notches cut. Approximately 2” of material was added to the maximum true length to allow trimming to the fitting body after insertion into the tap.

9-5.3. Remove the wedge sections by completing the cuts and form the Spiracoustic Plus liner section. Pull the wedge cuts together with tape, either individually or using a “draw-band.”

9-5.4. Trial-fit the liner into the sheet metal shell. Make circumference adjustments as required before taping the final liner seam. Apply SuperSeal HV coating to any rough or damaged grooves prior to final taping. Finished tapered liner section for tap, ready to install is shown in Figure 9-4. Crosstabs were used to pull the notches closed and all seams were sealed with UL 181 A-P pressure-sensitive acrylic tape.



Figure 9-3. Liner board on bench with V-notches

Note

It is necessary to make and install a straight collar section to finish out conical taps. These short sections must be pinned and buttered with SuperSeal HV coating.

The finished conical tap lining (see Figure 9-5) is inserted into the tap from inside of the assembled metal fitting. Apply pressure to full seat the insulation. Notice the close fit and added length that will allow trimming to the radius of the fitting body.

9-5.5. Using the fitting body as a guide, position the knife blade against the inside diameter of the body and trim the excess liner material from the conical tap liner section. Take care to cut the liner with the correct

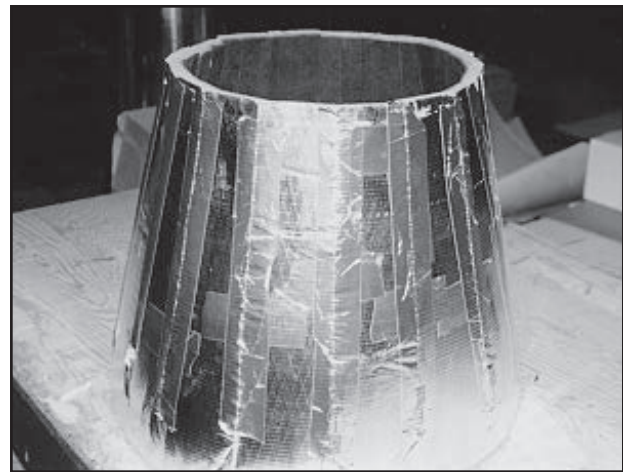

Figure 9-4. Tapered liner ready to install

angle/contour. This is most readily accomplished by holding the knife blade flush with inner surface of the body of the tee.

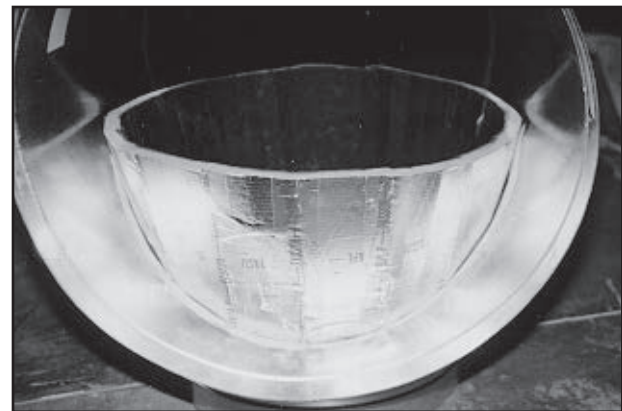

Figure 9-5. Conical tap lining inserted from inside

Figure 9-6 shows the excess length of the liner section carefully trimmed away, using the metal fitting shell as a guide for the cutting tool. A little extra care will produce a final cut contour that will have very few gaps.

A closeup of the specialized cutting tool (see Figure 9-7), often referred to as “serrated-blade kitchen knife.” A sawing motion is necessary to cut through the fiberglass and the FSK facing cleanly.

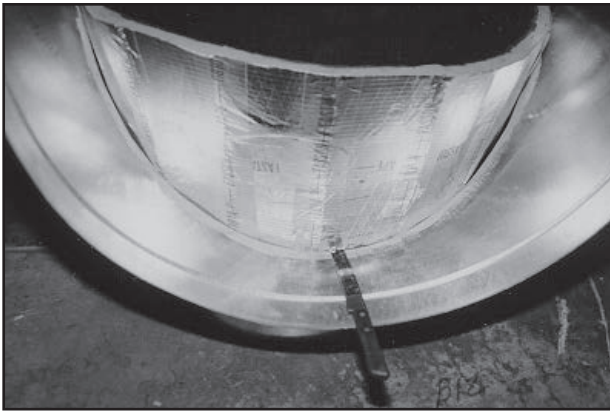

Figure 9-6. Trimming excess lining

The finished contour cut along tap edge exposes a large area of fiberglass due to the steep blade angle (see Figure 9-8). When the body of the fitting is lined, the cut will be completely covered by the insulation in the main body, which will also hold the tap securely in place.

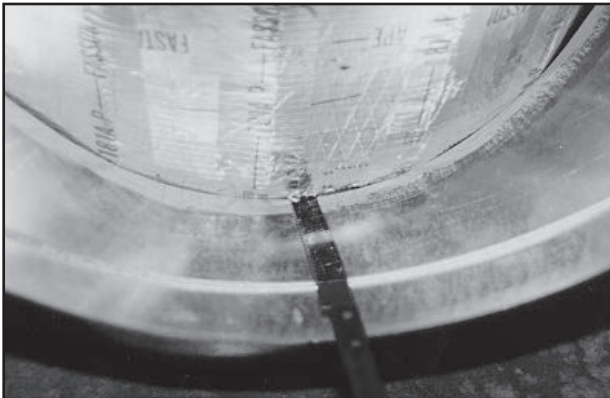

Figure 9-7. Closeup of serrated cutting tool

9-5.6. Cut a section of Spiracoustic Plus liner to fit the circumference of the main body of the fitting, allowing enough extra to be trimmed flush on each end. Form the Spiracoustic Plus duct liner into the round lining segment and tape the seam.

9-5.7. Using the branch, with liner in place as a guide for the knife blade, cut the opening in the body liner section. Use care not to cut into the branch liner material as the cut is made.

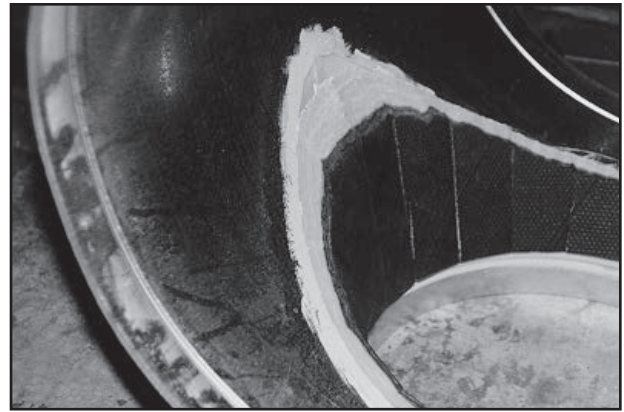

Figure 9-8. Finished contour cut

9-5.8. Carefully butter all fabrication cuts with SuperSeal HV coating. The airflow characteristics and steep cut angles of taps make this step critical.

Note

A long-bladed, sharp knife is preferred for cutting branch fitting intersections. Care must be taken not to delaminate the “blocks” of insulation when penetrating the interior of the liner from the exterior facing side.

Figure 9-9 is a closeup of cut contour, insulation removed from tapered tap for clarity. The radical angle of the cut will minimize gaps, ensure consistent insulation thickness and reduce the need for SuperSeal HV coating filler during final assembly.

Another view, Figure 9-10, shows cut tap insulation contour clearly. The angle of the cut follows the radius of the fitting body. Note how the exposed fiberglass is distinguishable from the coated airsteam surface and the metal. When the installation is complete, no fiberglass will be exposed.

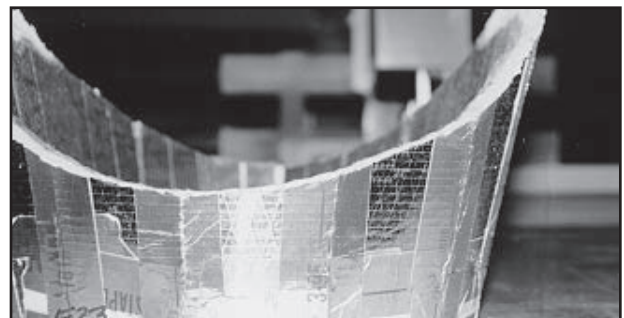

Figure 9-9. Closeup of contour cut, removed from tap

With the tap insulation completed (see Figure 9-11), a straight section of Spiracoustic Plus duct liner is installed in the main body of the fitting. This application is identical to a straight duct lining, with the exception that the fitting liner is cut to the length of the fitting body



Figure 9-10. Finished contour cut

Figure 9-12 shows the lined tap now used as a cutting guide for the opening in the body liner section. Note that the installer is reaching in through the tap. As previously shown, the cutting tool is held against the lined tap body to produce a cut with the correct contour. Use care not to damage the previously installed liner during this operation.

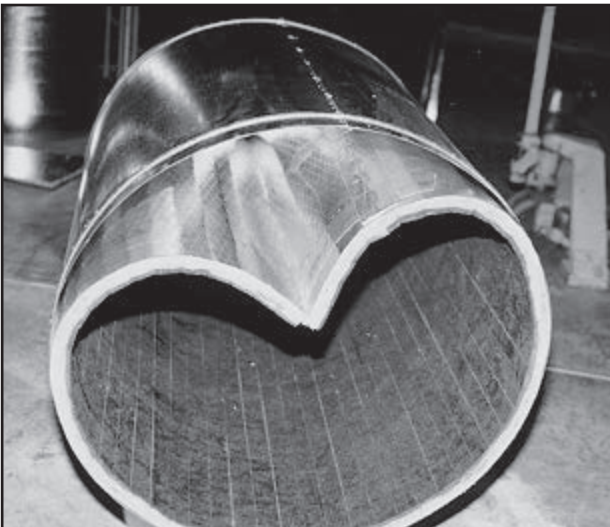

Figure 9-11. Installing straight section

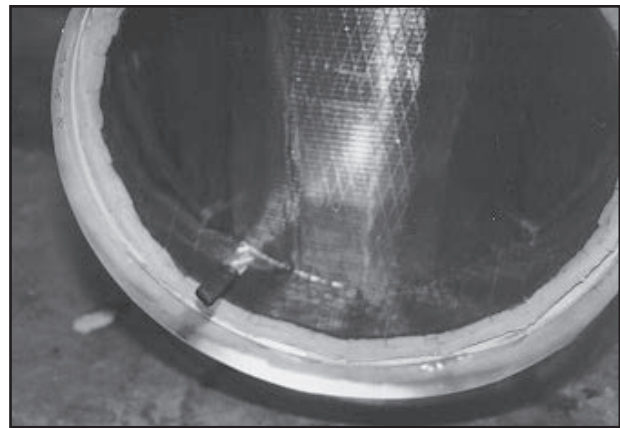

Figure 9-12. Use tap section as a guide to cut straight section

Figures 9-13 and 9-14 show views of the intersection of the tap and body from opposite sides. The high-density fiberglass closely conforms to the metal fitting body. The collar has not been installed in the tap. Completed fitting insulation is shown in Figure 9-15, with SuperSeal HV coating applied to all gaps and exposed fiberglass. Note that entire lining area is now coated and sealed. Also note that the liner body insulation holds tap insulation in place and tap insulation supports collar.

Figure 9-16 shows the tap of completed fitting. Raw edge may be buttered during fabrication to protect against damage during shipping and will be sealed with an additional bead of SuperSeal HV coating prior to installation. The collar may be pinned, secured with SuperSeal HV coating or installed with a buttered end bead of SuperSeal HV coating. Adjacent insulation section will completely lock collar in place.

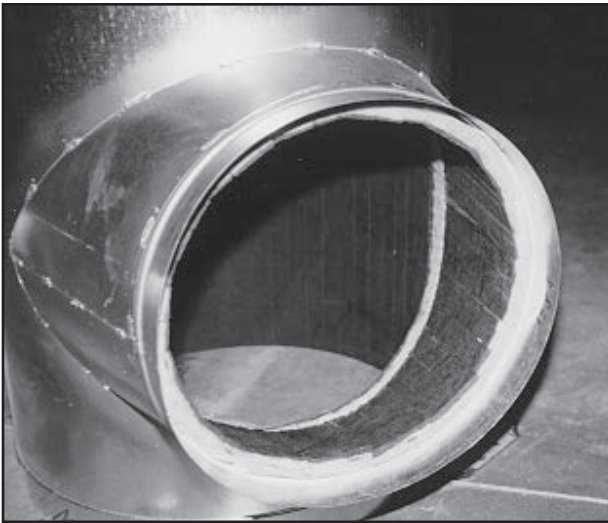

Figure 9-13. Outside view of tapered tap



Figure 9-14. Inside view of tapered tap

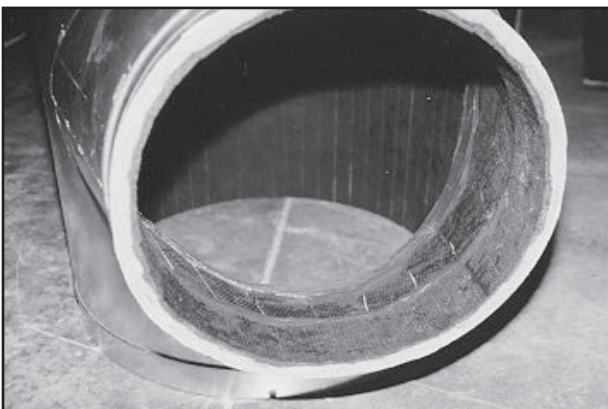

Figure 9-15. All gaps are sealed

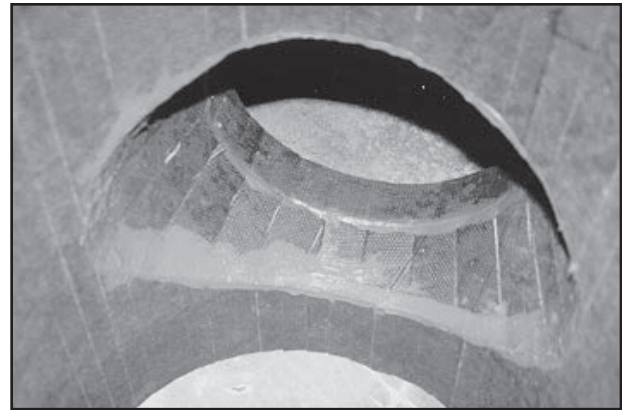

Figure 9-16. Finished fitting

9-6. Method Two: Flat Pattern Layout

This method is adaptable to most fitting types and generally reduces trim scrap over other methods. The trade-off is that more initial labor is necessary.

The selection of liner board versus fitting fab board is usually based on overall length of the reducer (applies to all reducers). With Spiracoustic Plus duct liner, the factory kerfs do not remain aligned with the airflow. When the misalignment exceeds 30°, fitting fab board must be used with segmented fittings, similar to that shown in the following example.

Using flat patterns is generally reserved for large fittings or where multiple identical fittings are being lined. Figure 9-17 shows flat pattern placed on bench with Spiracoustic Plus fitting fab board. The pattern was produced using a plasma cutter. Note the layout tick marks that will produce cutting guide lines.

9-6.1. Produce a sheet metal pattern (or the unformed blank) for the conical tee and secure the pattern on a sheet of Spiracoustic Plus fitting fab board. Note that the addition of tick marks or other layout marks on the pattern will improve the accuracy of the final insulation piece.

Figure 9-18 shows the fitting fab board with pattern marks transferred and partially cut. A white or red pencil works well for marking the black acrylic airstream surface.

9-6.2. Cut the insulation using the pattern as a guide. If the pattern is a duplicate of the sheet metal fitting or a blank, it may be necessary to accommodate allowances. Leave 1" - 2" of extra material on the intersecting portion of the tee liner for trim. For best results, begin by scoring the surface. Then follow with a final cut through the fiberglass and FSK facing.

9-6.3. With the Fitting Fab Board blank on the bench with the coated airstream surface up, transfer the tick marks or other layout marks from the pattern. Alternately, make a series of marks along the large end of the blanks at approximately $3 \frac{3}{16}$ " (π) intervals.

9-6.4. Using a 15° V-groove hand tool (Amcraft "White" 15° tool), cut radial grooves, approximating the layout shown in Figure 8-11. The vee groove should be $\frac{3}{4}$ " to $\frac{7}{8}$ " through the fiberglass and should not score the facing. It's good practice to mark the radial grooves prior to cutting. This is especially helpful when grooving eccentric reducer blanks.

Figure 9-19 shows the radial grooves hand cut using an Amcraft "White" 15° tool. The conical liner section may now be formed and taped for insertion into the tap.

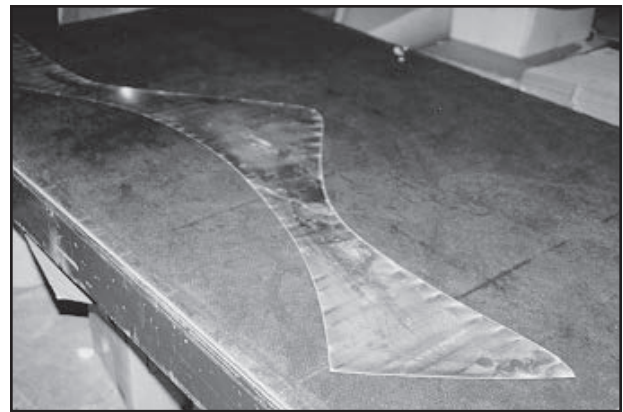

Figure 9-17. Flat pattern on bench

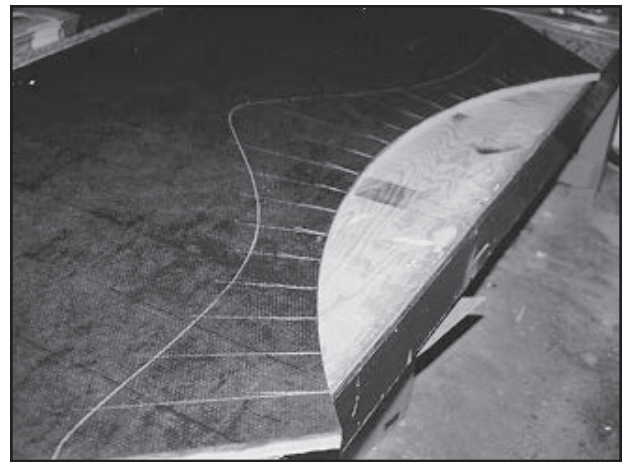

Figure 9-18. Partially cut Fitting Fab Board

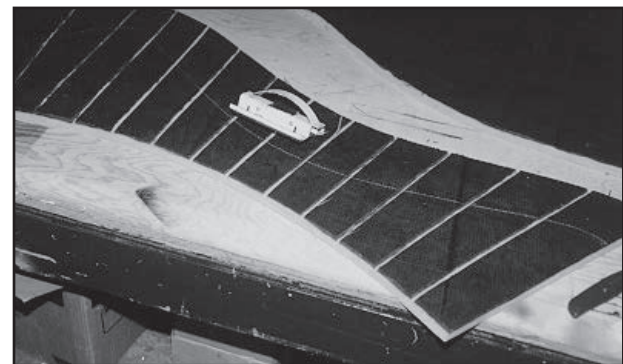

Figure 9-19. Hand-cut radial grooves

9-6.5. To complete the fitting, follow the steps in paragraphs 9-5.5 through 9-5.8. Following installation into the tap, the insulation contour cut is made (see Figure 9-20). As standard practice, the tap is always cut first, so that the fitting body insulation will support the tap insulation. Compare this photo with Figure 9-5. The flat pattern method used in this example may require less material. On the other hand, the setup requirement is more time consuming. This method is most effective on very large fittings or where multiple identical fittings are required.

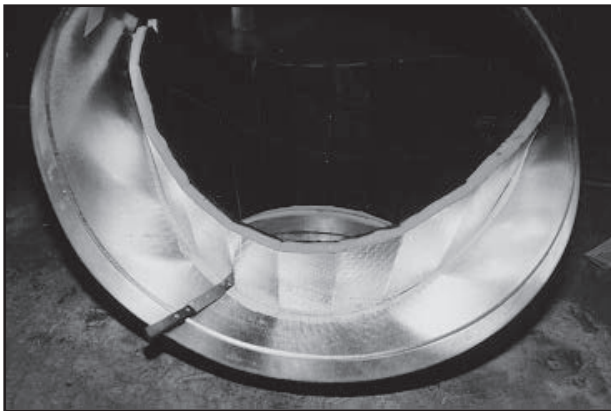

Figure 9-20. Cutting the insulation contour

9-7. Rectangular (Diffuser) Taps

Rectangular taps are frequently used for direct mount diffusers or grills. Several different mounting methods may be used, but all require securing the liner. As noted in paragraph 9-2, branch fittings and tap-ins require removal of Spiracoustic Plus duct liner in the opening created by the tap. Cuts longer than 12" overall (measured along the duct length) must be supported by mechanical fasteners channels, or Z-clips to retain the liner integrity.

9-8. Securement Options

9-8.1. Mechanical fasteners must be spaced approximately 12" (max.) on center around the tap-in opening, 2" (min.) in measured from the cut. Fasteners may be approved liner pins or screws through washers against the insulation airstream.

9-8.2. If conditions permit the use of Z-clips, the clips must be spaced approximately 12" (max.) on center and overlap the liner surface by the thickness of the liner.

9-8.3. For rectangular taps, channel or Z-bar with a minimum liner surface overlap equal to the thickness of the liner is preferred over pins or mechanical fasteners.

Figure 9-21 shows a lined section of duct with short rectangular tap attached. The length of tap varies. Longer taps weaken both liner and metal duct shell.

Interior view of tap is shown in Figure 9-22. Cutout edges of liner are secured with channel on longitudinal cuts and washers with screws on circumferential cuts. Note that spiral seams of metal duct have been retained to ensure structural integrity and dimensions of duct.

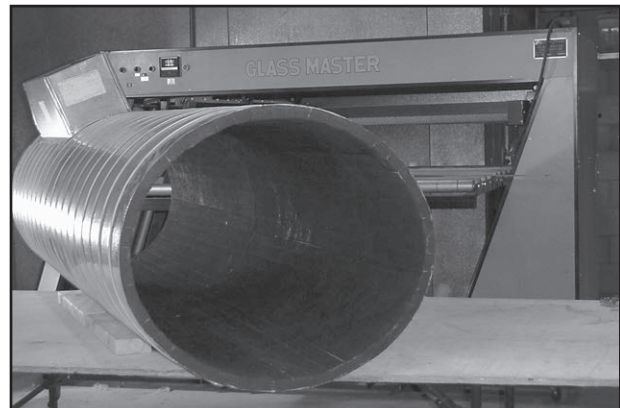

Figure 9-21. External view of rectangular tap

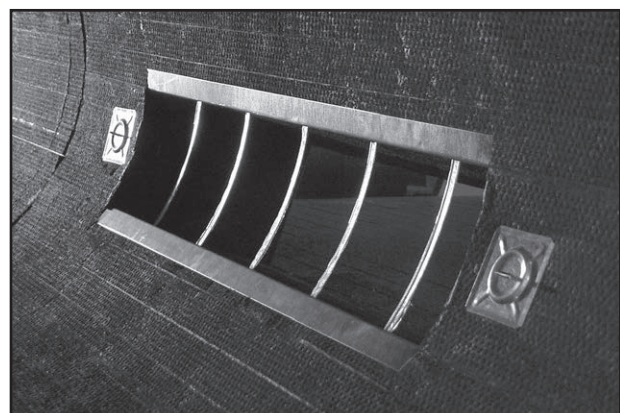

Figure 9-22. Internal view of rectangular tap



717 17th St.
Denver, CO 80202
800-866-3234
JM.com

**North American Sales Offices,
Insulation Systems**

Eastern Region and Canada

P.O. Box 158
Defiance, OH 43512
800-334-2399
Fax: 419-784-7866

Western Region

P.O. Box 5108
Denver, CO 80217
800-368-4431
Fax: 303-978-4661

Technical specifications as shown in this literature are intended to be used as general guidelines only. Please refer to the Safety Data Sheet and product label prior to using this product. The physical and chemical properties of the products listed herein represent typical, average values obtained in accordance with accepted test methods and are subject to normal manufacturing variations. They are supplied as a technical service and are subject to change without notice. Any references to numerical flame spread or smoke developed ratings are not intended to reflect hazards presented by these or any other materials under actual fire conditions. Check with the Regional Sales Office nearest you for current information.

All Johns Manville products are sold subject to Johns Manville's standard Terms and Conditions, which includes a Limited Warranty and Limitation of Remedy. For a copy of the Johns Manville standard Terms and Conditions or for information on other Johns Manville thermal insulation and systems, visit www.jm.com/terms-conditions or call (800) 654-3103.