



Johns Manville



Hot Asphalt



Adhered



Hot Air Weld



Mechanically
Fastened



PVC Roofing Systems

Commercial Roofing Application Guide

Table of Contents

Section One

Roof Insulation Application Guide	1-1
Roof Insulation Fastener Placement	1-3
Roof Insulation Detail Patterns	1-10

Section Two

PVC Membrane Application Guide.....	2-1
-------------------------------------	-----

Section Three

PVC Mechanically Fastened Fastening Patterns	3-1
--	-----

Section Four

PVC Membrane Flashing Details	4-1
-------------------------------------	-----



Download a free QR Reader app on your smart phone. When you see a QR code, use your phone to scan the code. It will then redirect your phone to a specific video or detail. These codes will allow you to view step by step instructional videos and will allow you to zoom in on details for better readability. If you are viewing this booklet online you can click on these codes to direct you to the online videos and details as well.

Disclaimer:

The PVC Roofing Systems Commercial Roofing Application Guide is intended as a guide only; actual conditions encountered during installation may vary from jobsite to jobsite. By providing this guidance, Johns Manville assumes no responsibility for quality of installation, field workmanship, building code compliance, or job safety. Johns Manville Material Safety Data Sheets (MSDS) are available with specific product safety information. For information on other Johns Manville thermal insulations and systems, call (800) 922-5922 or visit JM.com.

1

Roof Insulation Application Guide, and Fastening Patterns

Insulation Installation Considerations

It is important to know that all Johns Manville polyiso boards are printed with installation directions of "This side down". This installation method is required for adhered systems and recommended when used under mechanically attached membranes.

Foam insulation products are combustible and should be properly protected from exposure to fire during storage, transit, and application.

Storage

JM roof insulations (polyiso, Invinsa[®], and FESCO[®]) are shipped with plastic shrouds that are intended to temporarily protect the insulation while in transit. JM continues to work on improving the packaging of our JM cover boards and insulation products. There are two packaging methods (plastic wrap or plastic bag) that are used depending upon the product and the manufacturing facility. No matter how packaged, JM insulation should not be stored in or around standing water. Since all packaging is 5-sided, the pallets should be elevated and stored on a finished surface rather than on dirt or grass. Exercise care during handling to prevent insulation damage; avoid pushing pallets off the truck, rolling pallets on the ground or roof, and removing the package support feet. No more insulation should be installed than can be completely covered with membrane on the same day.

- **Plastic Wrap Packaging** is shipped to the job site with tarps. At the job site this packaging is adequate for outside storage without tarps provided the insulation arrives intact with the original undamaged weather-tight plastic wrap, for two weeks or less.



For storage greater than two weeks, JM recommends slitting the plastic shrink wrap prior to covering the pallet with a breathable tarpaulin, to allow for venting. For storage greater than one month, insulation should be stored indoors in a dry, well-ventilated warehouse.

- **Plastic Bag Packaging** is shipped to the job site without tarps as this packaging protects the insulation during shipment. For storage less than two weeks, the packaging is adequate for outside storage without tarps provided the insulation arrives intact with the original undamaged weather-tight plastic bag. For storage greater than two weeks, JM recommends slitting the plastic shrink bag prior to covering the pallet with a breathable tarpaulin, to allow for venting. For storage greater than one month, insulation should be stored indoors in a dry, well-ventilated warehouse.

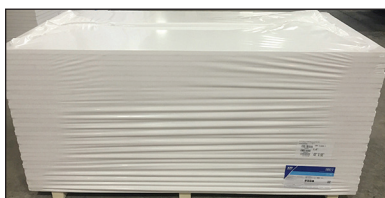

Installation

Insulation must be independently fastened to the roof deck in mechanically attached and adhered systems. Adhering certain insulations in hot asphalt or cold adhesives is sometimes acceptable for adhered systems (only for 4x4 boards). For specific requirements, contact the JM Technical Services Group.

Always cut insulation to fit closely around all roof penetrations. Around drains, and primary scuppers, taper insulation a minimum of 36" x 36" (91.44 cm x 91.44 cm) for proper drainage.

Apply rigid insulation directly over fluted steel decks to provide smooth, continuous membrane support. Insulation should be installed with long edges parallel to the direction of the deck and supported by the deck flange. When butting insulation layers, do not allow the edge of either board to overlap an open flute. Cut the

insulation so the edge of the board is about at the center of, and supported by, the flange. Any gaps between insulation greater than 1/4" should be filled.

Double Insulation Layers.

Installing roof insulation in multiple layers provides the designer with improved thermal performance. It also contributes to the overall performance of the roof system for the following reasons:

- Recent studies indicate that as much as 8% of the thermal efficiency of the insulation can be lost through the insulation joints and exposed insulation fasteners of single layer installations. Insulation joints that are staggered in multiple layer installations block the flow of heat.
- Multiple layer insulation installation reduces the stress accumulation of a thick, single insulation joint and distributes the stress more evenly over the multiple, thinner insulation joints.
- The bottom side of the membrane is protected from physical damage from insulation plates and fasteners by the second layer of insulation if the top layer is adhered.
- Roof decks may be stiffened.



Asphalt Temperatures

JM endorses the guidelines established by the NRCA and ARMA for heating asphalt for proper insulation applications. Asphalt should be applied at the Equiviscous Temperature (EVT), $\pm 25^{\circ}\text{F}$ ($\pm 14^{\circ}\text{C}$).

Cold Weather Application

Hot asphalt chills rapidly at 40°F (4°C). To avoid problems associated with "cold" asphalt application, insulation may be applied with mechanical fasteners. Another method when using hot asphalt may be the "mop and flop" method. The "mop and flop" method entails mopping the back of the insulation so that the asphalt retains its adhesive qualities for a longer period. When adhering insulation, including hot asphalt, board size shall not exceed $4' \times 4'$ ($1.22 \text{ m} \times 1.22 \text{ m}$). Care should be taken in any application below 40°F (4°C).

Mechanical Application to Steel Decks

Mechanical attachment of insulation to steel decks is the only acceptable attachment method. For current information regarding Factory Mutual requirements over insulated steel decks, please check with a JM Technical Services Specialist, or the current FM ApprovalsSM RoofNav[®].

Adhesive Application

JM insulations may be installed in Insulation Adhesives:

- Two-Part Urethane Insulation Adhesive (2P-UIA)
- One-Step Foamable Adhesive
- Roofing Systems Urethane Adhesive

Board sizes shall not exceed $4' \times 4'$ ($1.22 \text{ m} \times 1.22 \text{ m}$). Refer to product data sheets for adhesive coverage rates.

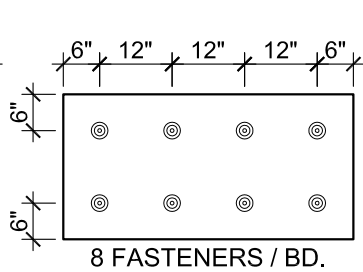
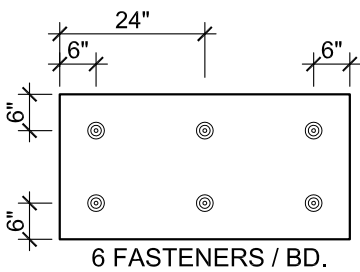
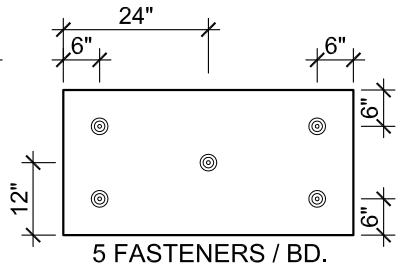
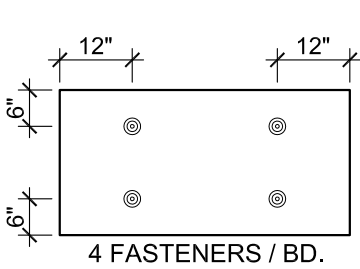
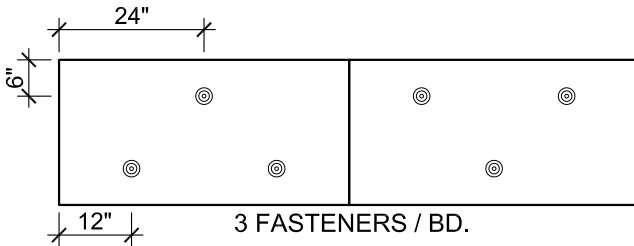
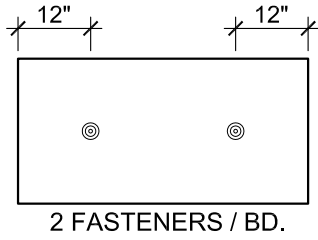

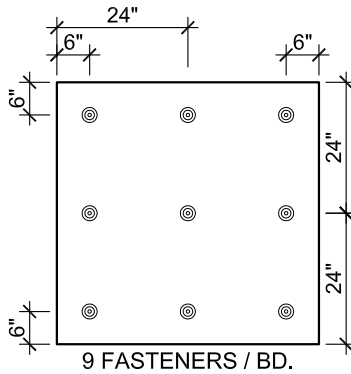
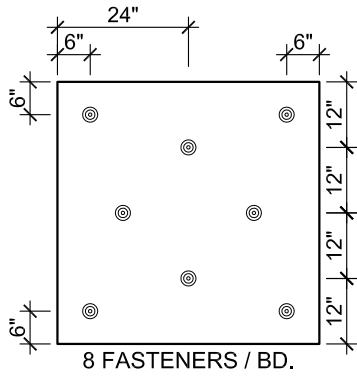
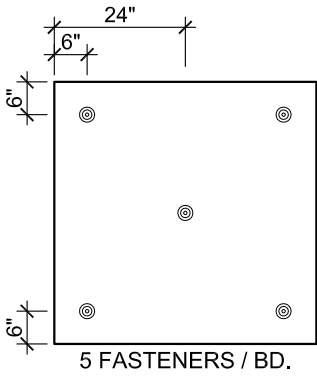
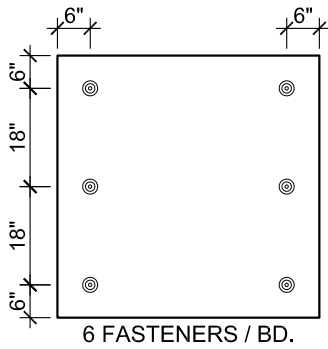
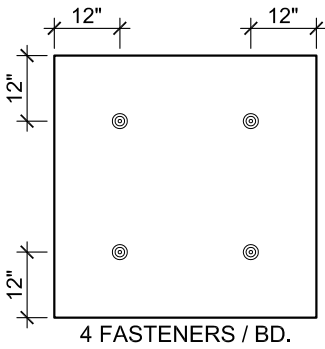

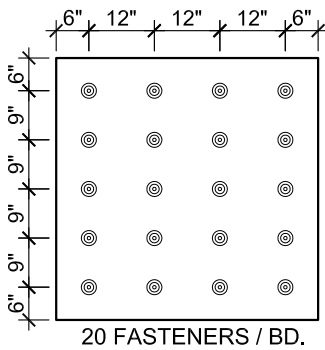
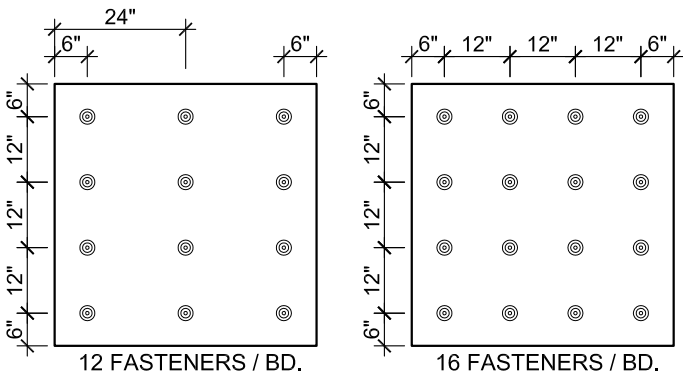
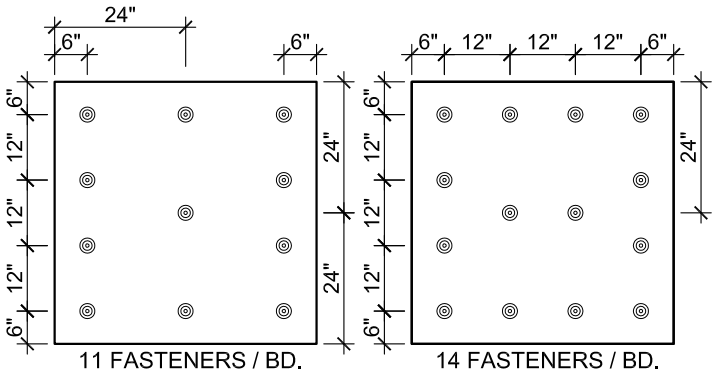

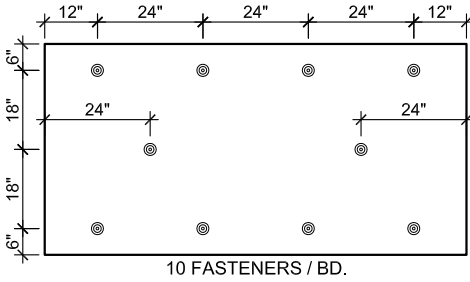
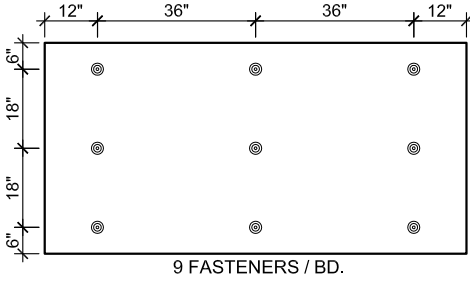
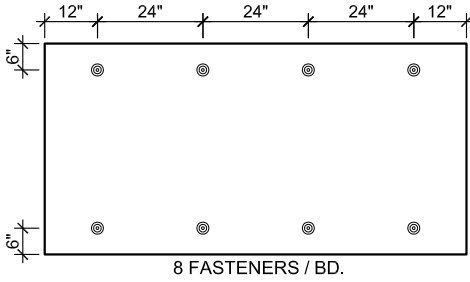
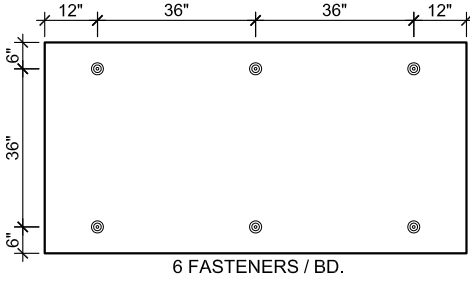
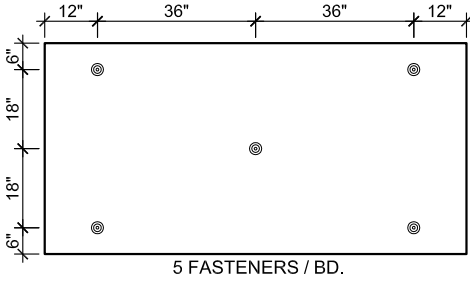

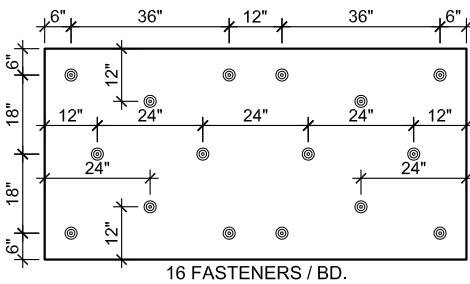
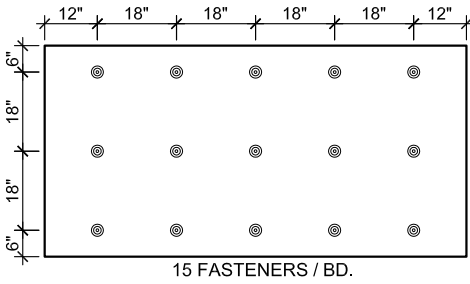
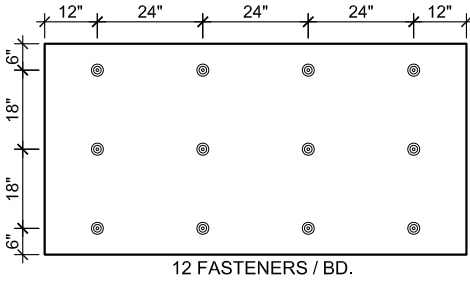
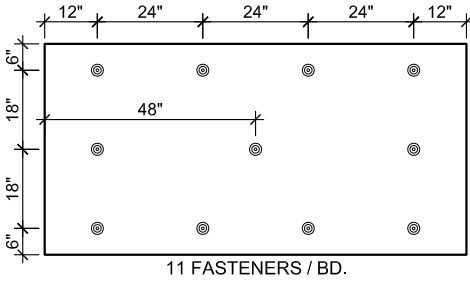

Roof Insulations Fastener Placement

4' x 8' (1.22 m x 2.44 m) Boards

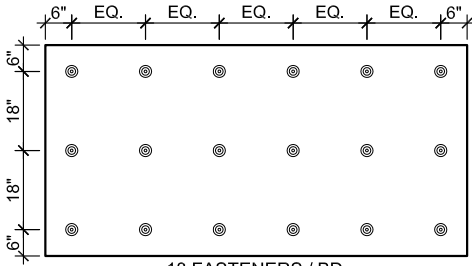

18 FASTENERS / BD.

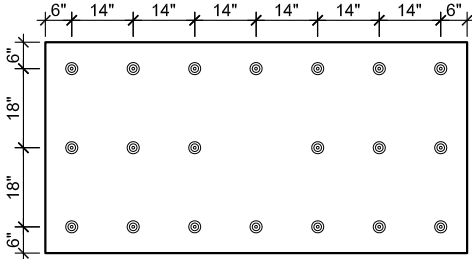

20 FASTENERS / BD.

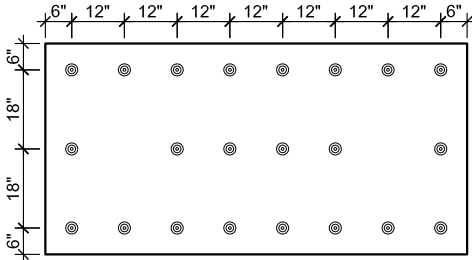

22 FASTENERS / BD.

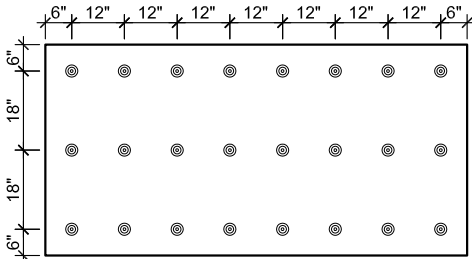

24 FASTENERS / BD.

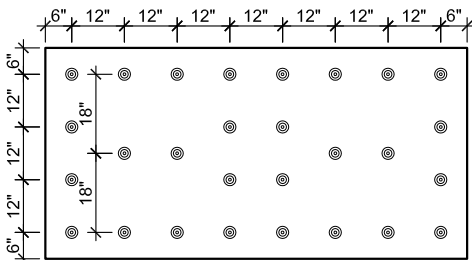

28 FASTENERS / BD.

Roof Insulations Fastener Placement

4' x 8' (1.22 m x 2.44 m) Boards

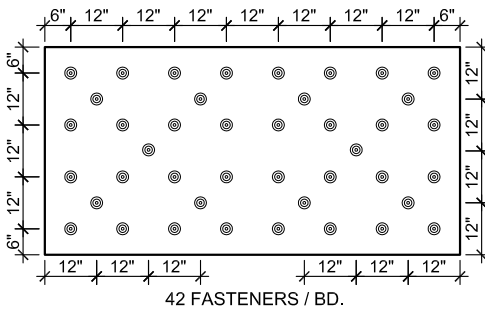
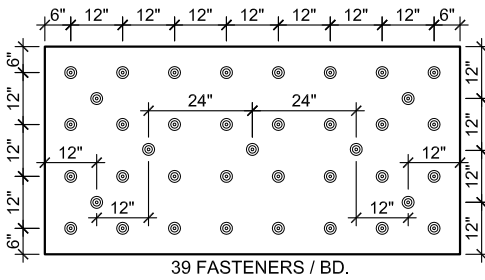
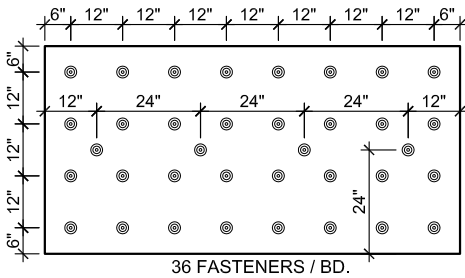
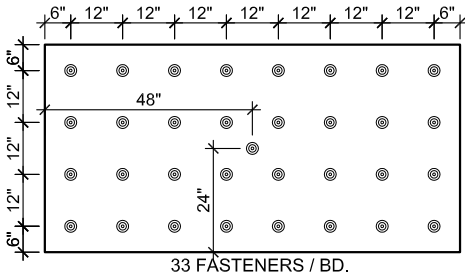
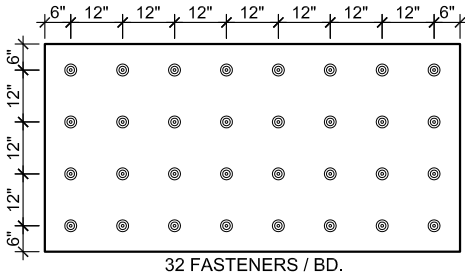

BOARD LAYOUT

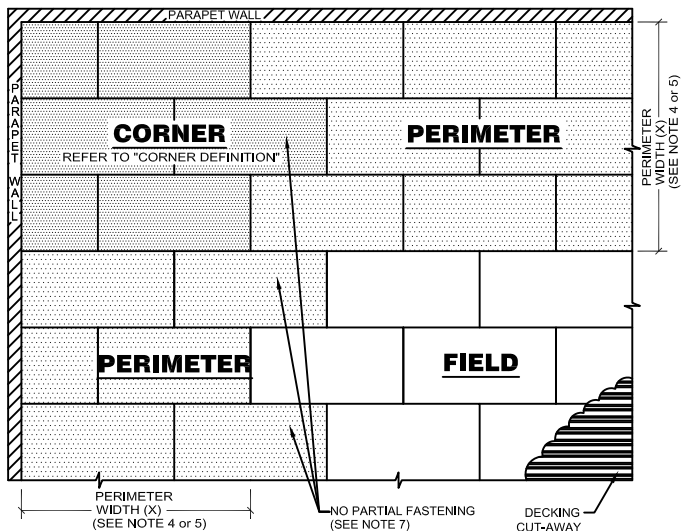

8 FASTENERS (1:4 FT²)

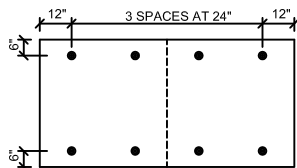

FIELD

16 FASTENERS (1:2 FT²)

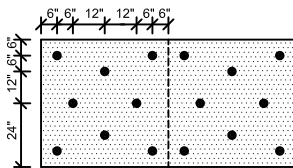

PERIMETER

32 FASTENERS (1:1 FT²)

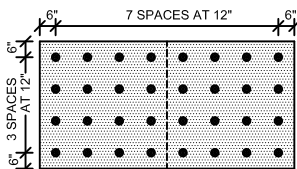

CORNER

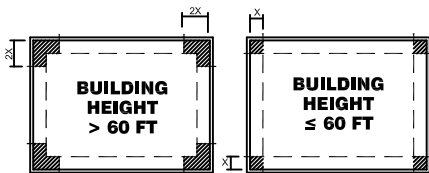

CORNER DEFINITION

(SEE NOTES 4, 5 & 6)

NOTES

1. CALCULATE UPLIFT DESIGN PRESSURES IN ACCORDANCE WITH ASCE-7.
2. INSTALL INSULATION WITH LONG JOINTS IN A CONTINUOUS STRAIGHT LINE WITH END JOINTS STAGGERED.
3. ROOF HEIGHT \leq 60 FT, THE PERIMETER (X) IS THE SMALLER DIMENSION OF:
 - 10% OF THE SHORTEST SIDE (PLAN VIEW)
 - OR
 - 40% OF THE ROOF HEIGHT,
 - BUT
 - NOT LESS THAN 4% OF THE SHORTEST SIDE (PLAN VIEW) OR 3 FT.
4. ROOF HEIGHT > 60 FT, THE PERIMETER (X) IS:
 - 10% OF THE SHORTEST SIDE (PLAN VIEW) BUT NOT LESS THAN 3 FT.
5. THE CORNERS MAY BE TREATED AS PERIMETERS IF THE PARAPET IS GREATER THAN OR EQUAL TO 3 FT ON ALL SIDES ACCORDING TO ASCE-7.
6. IF ANY PORTION OF THE BOARD LIES IN A PERIMETER OR CORNER ZONE, ENHANCE THE FASTENING OF ENTIRE BOARD.

BOARD LAYOUT

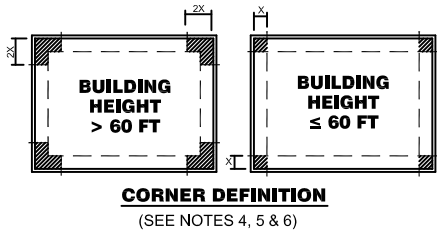
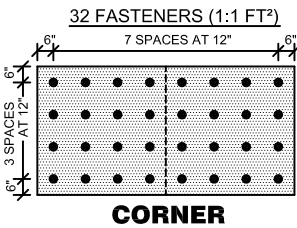
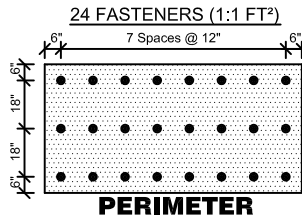
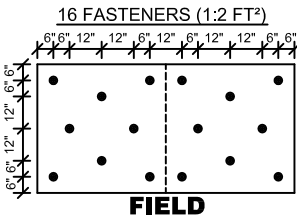
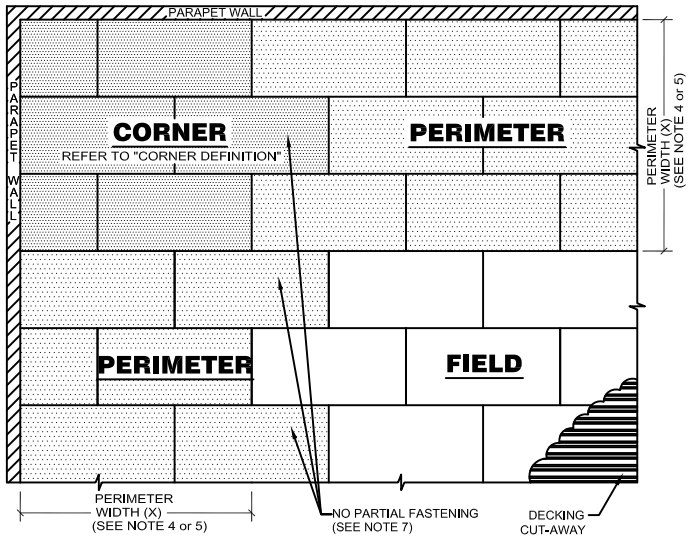

NOTES

1. CALCULATE UPLIFT DESIGN PRESSURES IN ACCORDANCE WITH ASCE-7.
2. INSTALL INSULATION WITH LONG JOINTS IN A CONTINUOUS STRAIGHT LINE WITH END JOINTS STAGGERED.
3. ROOF HEIGHT \leq 60 FT, THE PERIMETER (X) IS THE SMALLER DIMENSION OF:
10% OF THE SHORTEST SIDE (PLAN VIEW)
OR
40% OF THE ROOF HEIGHT,
BUT
NOT LESS THAN 4% OF THE SHORTEST SIDE (PLAN VIEW) OR 3 FT.
4. ROOF HEIGHT $>$ 60 FT, THE PERIMETER (X) IS:
10% OF THE SHORTEST SIDE (PLAN VIEW) BUT NOT LESS THAN 3 FT.
5. THE CORNERS MAY BE TREATED AS PERIMETERS IF THE PARAPET IS GREATER THAN OR EQUAL TO 3 FT ON ALL SIDES ACCORDING TO ASCE-7.
6. IF ANY PORTION OF THE BOARD LIES IN A PERIMETER OR CORNER ZONE, ENHANCE THE FASTENING OF ENTIRE BOARD.

INSTALLATION NOTES:

- A. ALL INSULATION/COVER BOARDS SHOULD BE 4'-0" x 4'-0".
- B. WHEN APPLYING MULTIPLE LAYERS OF INSULATION, IT IS REQUIRED TO RUN THE BEADS PERPENDICULAR TO THE PRECEDING LAYER WHEN USING 1-PART JM URETHANE ADHESIVE. IT IS OPTIONAL WITH JM 2-PART URETHANE ADHESIVE.

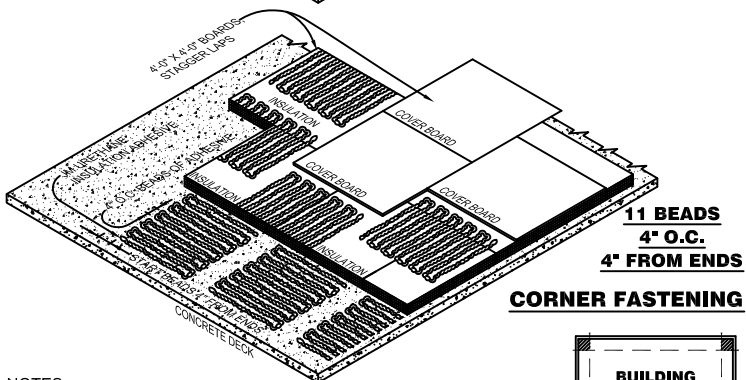
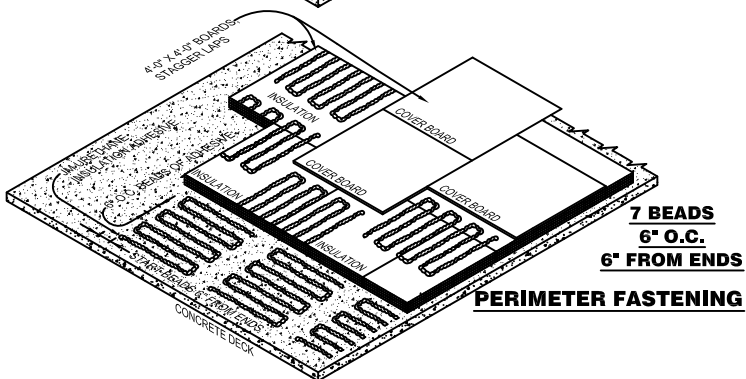
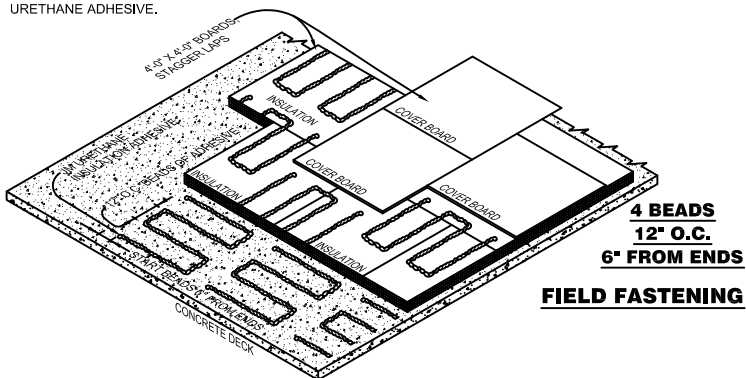

NOTES:

1. UPLIFT DESIGN SHOULD BE IN ACCORDANCE WITH ASCE-7.
2. UPLIFT RESISTANCE SHOWN IS BASED ON FMG 1-29 REQUIREMENTS AND RECOMMENDATIONS.
3. SYSTEM COMPONENTS AND DESIGN MUST BE VERIFIED TO BE IN ACCORDANCE WITH THIS LAYOUT.
4. ASCE-7 DEFINES THE PERIMETER (X) AS THE LESSER OF 10% OF LEAST HORIZONTAL DIMENSION OR .4 x THE HEIGHT, BUT NOT LESS THAN 4% OF LEAST HORIZONTAL DIMENSION OR 3 FEET FOR BUILDINGS UNDER 60 FT. IN HEIGHT. OVER 60 FEET IN HEIGHT, ASCE-7 DEFINES THE PERIMETER (X) AS THE LESSER OF 10% OF LEAST HORIZONTAL DIMENSION ONLY.
5. THE CORNERS MAY BE TREATED AS PERIMETERS IF THE PARAPET IS GREATER THAN OR EQUAL TO 3 FEET ACCORDING TO ASCE-7.

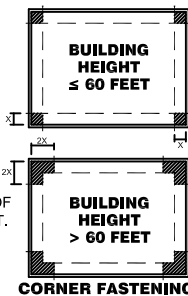

INSTALLATION NOTES:

- A. ALL INSULATION/COVER BOARDS SHOULD BE 4'-0" x 4'-0".
- B. WHEN APPLYING MULTIPLE LAYERS OF INSULATION, IT IS REQUIRED TO RUN THE BEADS PERPENDICULAR TO THE PRECEDING LAYER WHEN USING 1-PART JM URETHANE ADHESIVE. IT IS OPTIONAL WITH JM 2-PART URETHANE ADHESIVE.

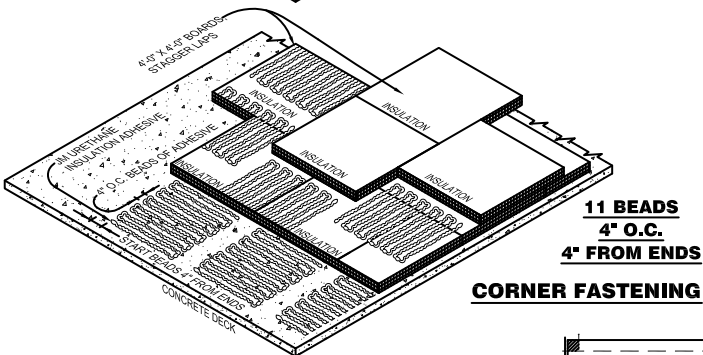
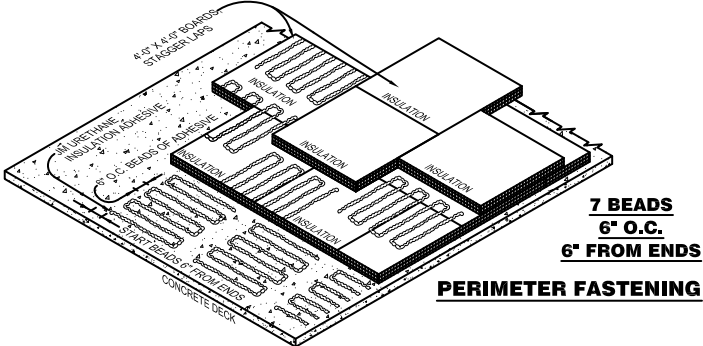
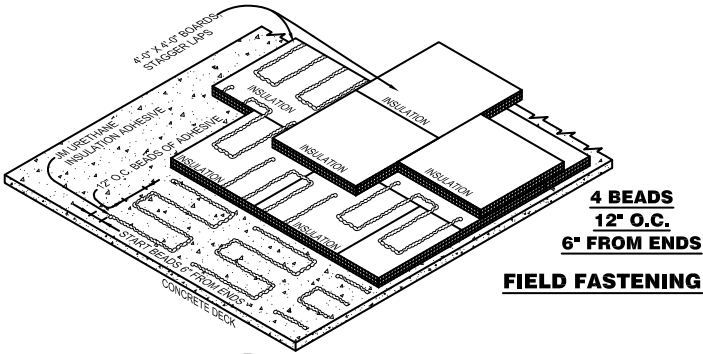

NOTES:

1. UPLIFT DESIGN SHOULD BE IN ACCORDANCE WITH ASCE-7.
2. UPLIFT RESISTANCE SHOWN IS BASED ON FMG 1-29 REQUIREMENTS AND RECOMMENDATIONS.
3. SYSTEM COMPONENTS AND DESIGN MUST BE VERIFIED TO BE IN ACCORDANCE WITH THIS LAYOUT.
4. ASCE-7 DEFINES THE PERIMETER (X) AS THE LESSER OF 10% OF LEAST HORIZONTAL DIMENSION OR .4 x THE HEIGHT, BUT NOT LESS THAN 4% OF LEAST HORIZONTAL DIMENSION OR 3 FEET FOR BUILDINGS UNDER 60 FT. IN HEIGHT. OVER 60 FEET IN HEIGHT, ASCE-7 DEFINES THE PERIMETER (X) AS THE LESSER OF 10% OF LEAST HORIZONTAL DIMENSION ONLY.
5. THE CORNERS MAY BE TREATED AS PERIMETERS IF THE PARAPET IS GREATER THAN OR EQUAL TO 3 FEET ACCORDING TO ASCE-7.

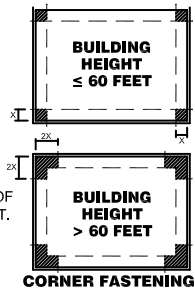

2

JM PVC Membrane Application Guide

Section Two Contents

1.0 Introduction	2.2
2.0 Roof Substrate Materials and Deck Preparation	2.3
3.0 Mechanically Fastened Systems	2.5
4.0 Adhered Systems	2.8
5.0 PVC Membrane with Redundant Bituminous Ply Sheets (Hybrid Systems)	2.14
6.0 Seaming, T-Joints, Penetrations, and Other Considerations	2.21



Download a free QR Reader app on your smart phone. When you see a QR code, use your phone to scan the code. It will then redirect your phone to a specific video or detail. These codes will allow you to view step by step instructional videos and will allow you to zoom in on details for better readability. If you are viewing this booklet online you can click on these codes to direct you to the online videos and details as well.

Disclaimer:

The PVC Roofing Systems Commercial Roofing Application Guide is intended as a guide only; actual conditions encountered during installation may vary from jobsite to jobsite. By providing this guidance, Johns Manville assumes no responsibility for quality of installation, field workmanship, building code compliance, or job safety. Johns Manville Material Safety Data Sheets (MSDS) are available with specific product safety information. For information on other Johns Manville thermal insulations and systems, call (800) 922-5922 or visit JM.com.

1.0 Introduction

This guide is designed for your convenience. These step-by-step instructions and illustrations should answer your installation questions and help you maintain top-quality craftsmanship when applying a JM PVC roofing system.

JM PVC Membranes are manufactured to meet a wide range of roof construction requirements. These membranes are used for mechanically attached, adhered, and induction welded roofing systems and are not intended for ballasted roofs.

Each membrane sheet is marked along the edge with lap lines. These lap lines indicate the minimum overlap required for mechanically fastened systems. A minimum 1½" (3.81 cm) welded seam is required for all systems.

Equipment

The following equipment may be needed to install JM PVC roofing systems:

Power Equipment

- 10,000 - 12,000 Watt Generators
- 100' 120V or 240V Extension Cord
- Screw Guns
- Hand-Held Hot Air Welder
- Robot Welder
- Hammer Drill
- Electric Drill
- Rhinobond Induction Welder and Magnets

Required Hand Tools and Equipment

- Brooms (Soft and Stiff)
- Gloves
- Measuring Tape
- Eye Protection
- Caulk Gun
- Scissors
- Silicone Rubber Roller
- Wire Brush
- Chalk Line
- Lawn Or Linoleum Roller
- Drill Bits (Carbide, Steel)
- Seam Probe
- First Aid Kit
- Utility Knives
- Rags
- Writing/Marking Instruments
- Rollers and Brushes
- Site Specific PPE

Misc Tools

- Rivet Gun
- Snips
- Hammer
- Pull-Out Tester
- Reciprocal and Circular Saw
- Hand Saw
- Metal Crimpers
- Vise-Grip Pliers
- Pliers
- Ladder
- Screwdriver Set
- Aluminum Tape
- Adhesive Applicator Gun or Cart
- T-Square
- Rubber Mallet
- Stirring Sticks
- Paddle Mixer
- Silicone Rubber Roller
- Shovels
- Tongs



2.0 Roof Substrate Materials and Deck Preparation

The primary function of a roof deck is to provide structural support and restraint for the roofing system. The deck must have adequate strength and rigidity to support all anticipated live and dead loads, foot or construction traffic, wind, rain and snow loads. The deck must have adequate strength and rigidity to carry the weight of the roofers and their equipment during construction, without deflecting to the point where roofing components rupture, delaminate or are weakened.

Some decks are designed to furnish inside appearance as well as sound control; however, JM's concern is for the roof deck as a base for the roofing system. To perform this function, the deck must be rigid. It must be smooth and free of large cracks, holes or sharp changes in elevation of the surface. It must be able to receive the roof system by some method which will hold the system securely, either by adhesion, ballast or mechanical fasteners. Before roofing work is started, the deck should be inspected carefully by the roofing contractor, the deck contractor and the owner's representative, to determine that it satisfies these conditions. The roofing contractor and JM are only concerned that the surface of the deck will accept the roofing system. Neither JM nor the roofing contractor have any responsibility regarding the adequacy of the deck from a structural standpoint.

Surface preparation should include filling and smoothing all holes, depressions, irregularities, etc., before the roof is applied.

Roof-mounted equipment should not rest on the deck or roofing system. It should be supported by the structural framing of the building. Leaks resulting from improperly mounted rooftop equipment are excluded from coverage under the JM Peak Advantage® Guarantee. **By such acceptance, JM accepts no responsibility of the structural adequacy or performance of the deck.**

To be a satisfactory substrate for any roofing system, a roof deck must have:

1. Proper construction, following the deck manufacturer's instructions.
2. Proper design to carry maximum anticipated live and dead loads which may be encountered during and after construction, without excessive deflection.
3. Positive drainage which will not allow water to pond. (See Roof Drainage paragraphs in this section.)
4. Expansion joints to allow for movement of the structure without causing strain on the roofing membrane. To be effective, expansion joints must extend through all elements of the roof and structural system.
5. A smooth, dry and properly cured surface to which the roofing system can be installed.
6. A solid, rigid assembly when using precast deck units. Units must be securely fastened to supporting members to prevent movement.
7. A continuous, uninterrupted surface. Installation of conduits on the top surface of a roof deck is not acceptable, unless the area between the conduits is filled with an acceptable roof insulation, properly secured, and a full thickness of roof insulation is installed over the conduits.
8. A clean surface. Before roofing application is started, the deck should be free of all dust, dirt, debris and foreign material. Only the roofer's tools and equipment should be allowed on the deck during roof application.
9. The proper resistance to wind uplift to prevent rupture of the roof membrane.
10. Adequate means of membrane securement. Provisions for special attachment procedures must be made on steep-slope decks.
11. Appropriate termination details. Under certain conditions, consideration should be given to isolating the roof membrane from stresses caused by deck or structural movement. This can be accomplished by securing base flashing to curbs attached to the structural deck. (See System Application section for flashing details.)

Any decks or substrates not listed in the current JM Commercial Roofing Product Manual must be approved by a JM Technical Services Specialist in writing prior to the installation of a roof which is to receive a Peak Advantage® Guarantee. Such approval only indicates that JM accepts the deck surface to receive a JM roofing system.

Nailers

After properly preparing the roof deck, install wood nailers when required. Place nailers on the perimeter of the roof, along the top of parapet walls and, where required, around roof penetrations and along roof expansion joints. Set the height of the nailers slightly lower than the height of the roof insulation (approx. ¼"). This will promote positive drainage across the edge where necessary and reduce the possibility of ponding at the edge of the building.

Space fasteners for wood nailers per the job specifications, but not greater than 24" (60.96 cm) o.c. with at least three fasteners per nailer, depending on nailer length. Each fastener must resist a minimum pull-out force of 200 lb/ft (298 kg/m) in any direction. Refer to FM data sheet 1-49 for wood nailer securement design considerations.

JM PVC-Coated Metal Flashings are fastened to wood nailers. When using membrane flashings, fasten the field sheet to the deck with a fastener/plate system.

Vapor Retarders

Vapor retarders prevent moisture or condensation from entering the building or passing from the building into the roof system. To provide an effective shield against water vapor, seal off all vapor retarders at roof edges and penetrations.

Air Barriers

Air barriers should be considered on jobs where high internal air pressure exists, such as airport hangars or distribution warehouses with many outside openings (such as loading docks), outdoor amphitheaters, etc.

Insulation

Refer to Roof Insulation Application Guide in Section One for details.

Slip sheets

When a slipsheet is used under the membrane on a mechanically attached system fasten with the sufficient amount of fasteners to keep all laps and edges secure. It should be neatly cut to fit closely against roof edges and around penetrations.

Coal Tar Pitch

Coal tar pitch roofs give off vapors which can affect JM PVC roofing membranes. You must separate coal tar pitch roofs from the JM PVC Membrane in the following manner:

- Place insulation with a minimum thickness of 1½" (3.81 cm) atop the roof, with the joints of the insulation butted together at all four sides.

Roof Preparation (Re-Roofing)

Proper roof substrate preparation is essential to simplify installation and prevent future conditions that may lead to roof leaks.

First, complete a moisture scan and ensure that any wet materials are clean and dry. Provide protection of the adjacent roof areas. Carefully sweep all roof surfaces to remove all debris and dirt. Make sure the roofing area is completely smooth. Be sure to power wash the substrate prior to installation especially in adhered systems. Cut out large blisters on asphalt or coal tar pitch roofs. Repair holes or cracks in concrete, greater than ¼" (6.35 mm) wide with non-shrink grout.



3.0 Mechanically Fastened Systems

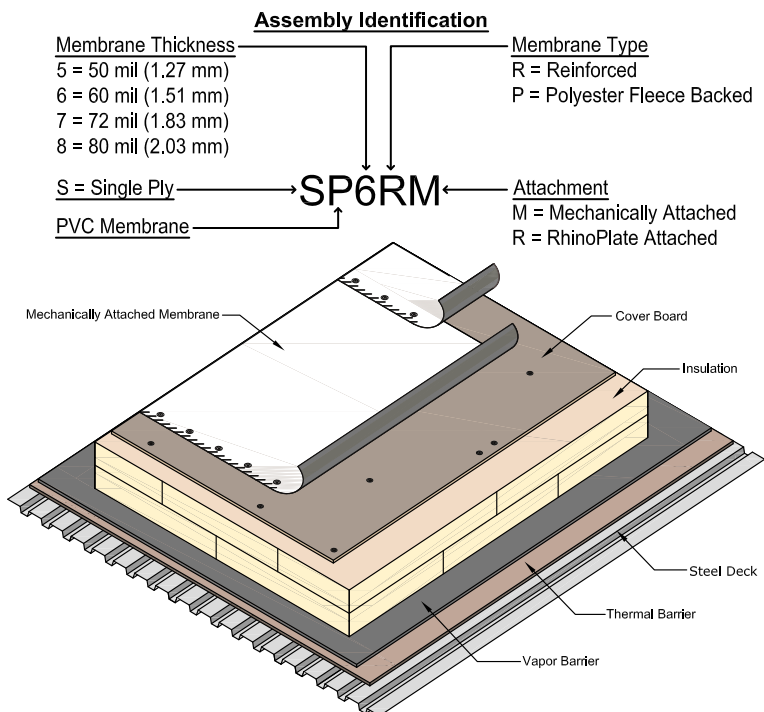

NOTE: For additional assembly plate variations, check out our interactive form online.

Installing Membranes

Unroll the JM PVC Membrane and position without stretching. Allow the membrane to relax at least 15 minutes when the temperature is above 60°F (16°C), or 30 minutes when the temperature is below 60°F (16°C), prior to installation. Inspect for any damaged membrane. Remove sections of the membrane that are creased or damaged. Pay special attention to membrane creasing at temporary tie-ins as this will be permanent.

Install all roof deck materials (vapor retarders, insulation and slip-sheet) in complete sections, and cover with the membrane immediately to produce weather-tight sections each day. **Phased construction is not permitted.**

For mechanically attached systems on steel decks, the membrane sheets must be applied **perpendicular** to the flutes of the deck.

To prevent wind uplift and secure the membrane on mechanically attached roofs, fasten the membrane to the roof deck with metal plates and acceptable fasteners.

Perimeter Areas

Refer to the local code requirements, project specifications, JM guarantee requirements, or FM Global® requirements when determining fastener rates. The requirements to calculate perimeter areas are as follows:

1. **Roof Height \leq 60 ft**, the perimeter is the smaller dimension of: 10% of the shortest side (plan view), or 40% of the roof height, but not less than 4% of the shortest side (plan view) or 3 feet.
2. **Roof Height $>$ 60 ft**, the perimeter is: 10% of the shortest side (plan view) but not less than 3 feet.
3. For mechanically fastened systems, spacing between fastener rows should be no greater than 60% of the width of the field sheets in the perimeters.
4. For induction welded systems, fastener rate (contributory area) shall be no greater than 60% of the field fastener rate.

Corner Areas

All corners shall be the intersections of the perimeter areas. Refer to the local code requirements, project specifications or FM Global requirements when determining corner layouts for perimeter sheets. If parapets are greater than 36" continuous the corners may be treated as a perimeter. Typically, one of the following layouts is used in the corners:

1. The perimeter rolls should be fastened all the way into the corner. The other perimeter sheets are fastened up to the previously installed perimeter sheets, and then the fastener rows are continued to the corner through the top of the previously installed sheets. Install a cover strip of reinforced membrane extending 2" (5.08 cm) on each side over the fasteners for a watertight seal. This method is commonly referred to as "picture framing".
2. The perimeter rolls should be run perpendicular to the flutes in steel deck applications. Additional fasteners should be installed in rows that are no greater than 40% of the width of the field sheets. These fastener rows should then be stripped in with reinforced JM PVC Membrane or JM PVC Reinforced Cover Strip. This method is commonly referred to as the "finger" method.
3. For induction welded systems, fastener rate (contributory area) shall be no greater than 40% of the field fastener rate.
4. For roof heights $>$ 60 ft (18m), "a" is 0.1 times the building lesser plan dimension, but not less than 3 ft (0.9m). Zone 3 is an ell with dimensions "2a".

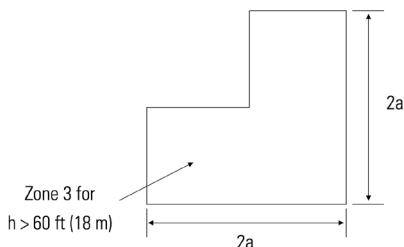

General Suggestions to Avoid Problems in Cold Weather (Below 50°F [10°C])

1. Store all JM PVC materials in warm 60°F – 80°F (16°C – 27°C), dry area away from sparks and open flames, to avoid condensation problems that could affect weld quality. Protect from freezing.
2. Take at least twice the usual number of seam samples to test for shear strength, since the possibility of inferior welds is greater.
3. Thoroughly dry all weld surfaces prior to welding.

4. Exercise caution when walking on dew, frost, ice or snow covered roofs, since the membrane may be extremely slippery.
5. Allow membrane to relax for a longer period of time.
6. Allow for extended adhesive flash off times.

In-Lap Mechanically

Fastening

The In-Lap Method

1. Roll out one roll of membrane over the acceptable substrate. Let it relax 15 to 30 minutes or as needed to compensate for any residual roll tension.
2. Secure the plate along the edge of the membrane, maintaining at least a ½" (1.27 cm) distance from the edge of the plate to the outer edge of the roll. Fastener and plate spacing is per FM Global requirements and/or job specifications or to meet JM guarantee requirements.
3. Tightly screw down the plates (do not overdrive the fastener) using an appropriate screw gun unit with adjustable clutch. Make certain to drive the fastener perpendicular to the surface of the substrate and to properly penetrate the deck surface. On steel decks, the screws must be fastened into the top flanges of the metal deck.
4. After securing the edge of the first membrane roll, roll out the next adjacent roll of membrane. Position this roll so that its common edge fully overlaps the row of plates and fasteners just installed. Maintain a minimum overlap of 6" (15.24 cm) (depending on plate size) to cover the plates, and leave the required ½" (3.81 cm) minimum for the seam weld.
5. Weld the overlap seam. Apply a bead of liquid JM PVC Edge Sealant along all cut edges of the seam.



Induction Welding

Insulation Attachment

Insulation must be fastened to the roof deck in PVC induction welded roof systems per the appropriate fastening pattern details, depending on membrane type and uplift requirements. For specific requirements, contact your JM Technical Services Specialist at (800) 922-5922. **NOTE: JM PVC induction weld plates must be used in JM PVC systems; JM TPO and JM PVC induction weld plates are not interchangeable. Note that PVC induction weld plates are black.**

Do not overdrive the plate and fasteners, as this will lead to poor bonding adhesion to the membrane when applied.

Take caution to ensure there is **no moisture on the board or membrane** prior to application. Any water or dew will decrease the bonded welding circumference. Induction weld plates are only approved for PVC membranes that are 60 mil thick and greater.

Induction Weld Method

1. Roll out one roll of membrane over the acceptable substrate. Let it relax 15 to 30 minutes or as needed to compensate for any residual roll tension.
2. Perform calibration and set up as detailed by the induction welder's owner's manual. Refer to the induction welder's owner's manual for setup, calibration and welding.



- Center the induction welder over the first plate in the pattern and activate the weld. **WARNING:** The induction welder must be centered over the plate to create a 100% bond. If an error occurs during activation, refer to the induction welder owner's manual for corrective action.
- Immediately place a cooling magnet over the welded plate. **WARNING: Keep magnet in place for at least 45 seconds while the assembly cools.**
- Repeat process for each plate.

To increase the pace, work across the sheet, moving cooling magnets from one row to the next as needed. It is best to work in the direction of the aligned rows.

To eliminate damage to the membrane, keep the magnets and surface of membrane clean and free from debris or contamination both prior and during the induction welding process. Always wipe the magnet clean when moving to the next plate. When removing the magnet do not twist it off, as it may damage the membrane.

To determine if a weld has been made, place the plunger next to a welded plate and create enough suction to lift the membrane. If welded, you will see a complete round outline of the plate. If the assembly is not welded, the membrane will lift up from the plate. Mark any plates that are not welded as a reminder to complete the weld.

Safety Guidelines: Induction welding requires special safety precautions prior to, during and after installation. When working with welding equipment, contractors must use extra care and extreme caution to prevent accidents. Carelessness can lead to loss of life, injury and loss of property. Installers should always reference the manufacturer's user manual for how to properly use the equipment.



4.0 Adhered Systems

Assembly Identification

Membrane Thickness

- 5 = 50 mil (1.27 mm)
- 6 = 60 mil (1.51 mm)
- 7 = 72 mil (1.83 mm)
- 8 = 80 mil (2.03 mm)

Membrane Type

- R = Reinforced
- P = Polyester Fleece Backed

S = Single Ply

PVC Membrane

SP5RA

Attachment

- A = Adhered
- U = Urethane Adhesive

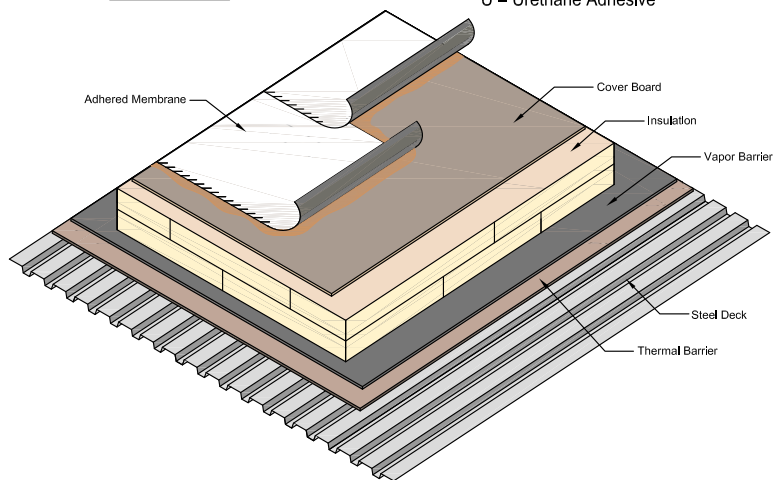

NOTE: For additional assembly plate variations, check out our interactive form online.

All membranes and substrates to be adhered must be approved by Johns Manville. Both surfaces must be clean, smooth, dry, compatible and free of contaminants and grease/oil. All fasteners, if required, must be properly seated and plates flush, leaving an acceptable surface to receive adhesive.

1. Roll out one roll of membrane over the acceptable substrate. Let it relax 15 to 30 minutes or as needed to compensate for any residual roll tension.
2. Position the membrane with a minimum 2" (5.08 cm) overlap between sheets. Fold membrane back one-half of the length of the first sheet's length to expose its bottom side.
3. Make sure adhesive container is sealed. Turn upside down and wait a minimum of five minutes then turn containers right side up. Carefully open and vigorously stir until adhesive is a uniform color and all solids are dispersed, with NO SWIRLS.
4. Saturate roller by dipping into can. Roll adhesive onto substrate and membrane for smooth-backed membrane, and substrate only for fleece-backed membrane.
NOTE: For solvent-based adhesives, the appearance of a spider web effect will occur with stringers off the roller when the roller needs to be redipped into the adhesive. It will also be hard to push the roller.
5. When adhesive is ready, carefully roll the membrane into the substrate avoiding wrinkles. Apply even pressure with a broom to ensure good contact between the membrane and substrate. Go back over the membrane with a lawn or linoleum roller (minimum 75 lb [34 kg]) to ensure no air pockets or voids occur.

Do not apply adhesive in the seam area; seams are to remain clean and dry. Avoid puddling of adhesive. With adhesives, more is not necessarily better. "Over-coating" adhesives will lead to poor adhesion.

Do not use in direct contact with polystyrene foam.

Adhesive coverage, open time and dry time rates can vary dramatically depending on the particular substrate and environmental conditions. Coverage rate charts, stated herein, are approximate only. If FM Global or UL® approval is required, please consult the specific RoofNavSM or UL Certification Directory for specific application rates.

General Suggestions to Avoid Problems in Cold Weather (Below 50°F [10°C])

1. Store all JM PVC materials in warm 60°F – 80°F (16°C – 27°C), dry area away from sparks and open flames, to avoid condensation problems that could affect weld quality. Protect from freezing.
2. Take at least twice the usual number of seam samples to test for shear strength, since the possibility of inferior welds is greater.
3. Thoroughly dry all weld surfaces prior to welding.
4. **Exercise caution when walking on dew, frost, ice or snow covered roofs, since the membrane may be extremely slippery.**
5. Allow membrane to relax for a longer period of time.
6. Allow for extended adhesive flash off times.

Use our Roof TechXpert app on your phone to get more accurate flash time estimates based on your current location.



Roof Tech Xpert

DOWNLOAD THE FREE APP



Suggested Coverage Rate Ranges				
Adhesive	Ft ² /gal (gal/sq)			
PVC Membrane Adhesive (Low VOC)	90 (1.11)	80 (1.25)	70 (1.43)	50 (2.0)
JM PVC Water Based Membrane Adhesive	180 (0.56)	160 (0.63)	140 (0.71)	120 (0.83)
Insulation & Cover Boards	← Less Adhesive / More Adhesive →			
	InvinSA/CGF			
	Gypsum*			
	ENRGY 3 (glass reinforced facer)			
				RetroPlus

*Gypsum includes SECUROCK Gypsum-Fiber, DensDeck Primed, and DEXcell FA

Notes: 1. Listed rates are for finished areas 2. See JM requirements for correct application method. 3. One-sided Applications (water based): Apply the full amount to the substrate only 4. Two-sided Applications (all adhesives): Apply approximately half the listed rate to the membrane and the remaining amount to the substrate. For porous substrates such as wood and gypsum, apply more adhesive on the substrate.



Two-Sided Application for Plain-Backed (Smooth-Backed) Membranes

Apply solvent-based adhesive in a smooth, even, thin coat to both membrane and approved substrate at the rates listed on specific product data sheets. Most applications apply approximately half the listed rate to the membrane and the other half to the substrate.

For porous substrates such as wood and gypsum, apply more adhesive on the substrate.



Do not allow adhesive on both sides to dry completely; if no longer tacky it cannot be used. PVC systems require adhesive to become tacky to the touch on both surfaces without stringers. Time will vary depending on the ambient temperature and humidity.

Cold Weather Application

Solvent and Low VOC/Solvent-Based Adhesives Cautions below 40°F

- **JM Membrane Bonding Adhesive should NOT be applied**
 - When ambient temperatures are 25°F (-3.8°C) or colder.
 - Adhesive temperature is at/below 32°F (0°C).

- Adhesive containers must be stored in a warming hut 60°F – 80°F (16°C - 27°C) when ambient temperatures are at or below 40°F (4.4°C). Protect from freezing.
- Opened adhesive being installed in cold weather applications that drops in temperature to the freezing point shall be restored to room temperature prior to continued use.
- In high relative humidity or when the dew point is within 10° degrees of ambient temperature.



Water-Based, Two-Sided Application for Plain-Backed (Smooth-Backed) Membranes

Apply water-based adhesive in a smooth, even, thin coat to both the membrane and approved substrate at the rates listed on specific product data sheets. Most applications apply approximately half the listed rate to the membrane and the other half to the substrate. For porous substrates such as wood and gypsum, apply more adhesive on the substrate.

Adhesive should be tacky at point of assembly: approximate time will vary depending on the environmental conditions. Once the adhesive begins to feel tacky, but with no stringers (as with the solvent adhesive), carefully roll the membrane to the substrate. Avoid capturing air or creating wrinkles during this process. If adhesive is completely dry or too wet, adhesion will be compromised. Apply even pressure to ensure good contact between the membrane and substrate.



Water-Based, One-Sided Application for Fleece-Backed Membranes Only

Apply the full rate of water-based adhesive to the substrate ONLY. Do not apply adhesive to the membrane. DO NOT apply to the membrane or in the weld area; keep both surfaces clean and dry. Assemble membrane and substrate while adhesive on the substrate is still wet. Apply even pressure with a lawn or linoleum roller (minimum 75 lb [34 kg]) to ensure good contact between the membrane and substrate.

• Water-based adhesives should NOT be applied:

- At temperatures below 40°F (or 5°C).
- At very high (>90%) relative humidity or when rain is expected.
- When the dew point* and the ambient temperature does not have a separation of more than 10° F and is not expected to be more during application time.
- When temperatures can be expected to fall below the dew point during application and/or up to 6 hours post application.
- When temperatures are expected to fall below freezing within 48 hours of application.

* Dew point definition - the temperature below which the water vapor in a volume of humid air at a given constant barometric pressure will condense into liquid water at the same rate at which it evaporates. Condensed water is called dew when it forms on a solid surface. The dew point is a water-to- air saturation temperature.

- Do not over apply. Use the coverage rate chart in this section; too much adhesive will result in curing issues.



JM Urethane Adhesive Installation Instructions

All applications must be approved by Johns Manville.

All surfaces must be clean, smooth, dry, compatible and free of dirt, debris, oil/grease and gravel. All fasteners, if required, must be properly seated and plates flush, leaving an acceptable surface to receive adhesive.

Packaged in 1,500 ml Cartridges

Remove the molded cap at the top of the cartridge and attach the supplied static-mixing nozzle to the threaded mixing head. Place the cartridge into the appropriate applicator.

Packaged in 5-Gallon Bladder

Remove bladder from box. Remove the white disc closure from the top of the packaging and extend quick-connect spouts in both Part 1 and Part 2 boxes. Invert bladder and place in appropriate tray on the approved application rig.

Box labeled "Part 1" must be in area of tray labeled "Part 1" and box labeled "Part 2" in area labeled "Part 2."

- Connect the black Part 1 fitting to the black inlet hose fitting
- Connect the gray Part 2 fitting to the gray inlet hose fitting
- Operate pump according to manufacturer's instructions
- On a scrap piece of material, dispense a small amount of RSUA. Let rise to ensure equipment and adhesive are on-ratio

For Membrane Application

1. Unroll the membrane and allow it to relax at least 15 minutes before applying adhesive; longer time may be necessary in colder weather.
2. Position the membrane with a minimum 2" (5.08 cm) overlap between sheets.
3. Fold membrane back one-half of the length of the first sheet's length to expose its bottom side.

For Board and Membrane Application

Apply directly to the substrate and allow it to begin to rise and build body before placing fleece-backed membrane or board stock into the adhesive.

- **Membrane attachment requires the membrane be rolled with a 150 lb roller to ensure positive contact between membrane, adhesive and substrate.**
- Board stock attachment requires the board stock to be walked in to ensure positive contact between the board stock, adhesive and substrate.
- Do not allow the adhesive to skin over. Eliminate uneven surfaces to ensure positive contact between the insulation board/ membrane and substrate.

Typical Lock-Down/Tack-Free Times

Ambient Temperature	Lock Down/Tack Free Time
40°F	9-10 minutes
60°F	6-7 minutes
80°F	4-5 minutes
100°F	3-4 minutes

Unused material can be applied at a later date by simply plugging the cartridges (with provided caps) and using a new static mixing nozzle. When using the box packaging, properly clean dispensing wand and pump unit according to the pump manufacturer's recommendation.

Coverage — Fleece-Backed Membranes

Bead spacing: 12" o.c. • Applied bead size: 3/4" min.

Packaging	Typical Coverage Rates		
	per package*	ft ² /gal	gal/100 ft ² *
Cartridge	600 ft ² /case	189	0.5
5 gal	2,000 ft ² /set**	200	
15 gal drum	6,000 ft ² /set**		
50 gal drum	20,000 ft ² /set**		

Coverage — Fleece-Backed Membranes

Bead spacing: 6" o.c. • Applied bead size: 3/4" min.

Packaging	Typical Coverage Rates		
	per package*	ft ² /gal	gal/100 ft ² *
Cartridge	300 ft ² /case	94	1.1
5 gal	1,000 ft ² /set**	100	1.0
15 gal drum	3,000 ft ² /set**		
50 gal drum	10,000 ft ² /set**		

Coverage — Fleece-Backed Membranes

Bead spacing: 4" o.c. • Applied bead size: 3/4" min.

Packaging	Typical Coverage Rates		
	per package*	ft ² /gal	gal/100 ft ² *
Cartridge	200 ft ² /case	63	1.59
5 gal	667 ft ² /set**	67	1.49
15 gal drum	2,000 ft ² /set**		
50 gal drum	6,667 ft ² /set**		

* Coverage rates are approximate and may vary based on substrate type and application. Approved substrates include structural concrete decks, JM Vapor Barrier SA, ENRGY 3, RetroPlus, DuraBoard, Invinsa, Securock, DensDeck, DensDeck Prime, smooth modified asphalt membranes and granulated asphalt membranes. Please contact JM Technical Services for other approved substrates.

** A set is defined as an equal Part 1 and Part 2.



NOTE: For additional assembly plate variations, check out our interactive form online.

These specifications are also for use over JM roof insulations (Fesco[®], Tapered Fesco[®], Fesco[®] Foam, Tapered Fesco[®] Foam, ENRGY 3[®], Tapered ENRGY 3[®], ½" [13 mm] Retro-Fit™ Board, or approved gypsum cover board) or other approved insulations that offer a suitable surface to receive the roof. These specifications are not to be used over lightweight insulating concrete decks or over a fill made of lightweight insulating concrete.

Non-nailable specifications are denoted by an "I" as the third character in the specification designation (e.g., 4GIT).

PVC Membrane with Redundant Bituminous Systems Over Nailable Decks

These specifications are for use over any type of structural deck (with or without insulation) which can receive and adequately retain nails or other types of mechanical fasteners recommended by the deck manufacturer. Examples of such decks are wood and plywood. Certain specifications are eligible for use over lightweight insulating concrete decks or over fill made of lightweight insulating concrete. Contact a JM Technical Services Specialist for approval of the lightweight fill to be used.

General Guidelines for Application of Materials

5.1 The proper application of roofing materials is as important to the satisfactory performance of the roof membrane as the materials themselves. JM suggests the following guidelines for application of all roofing materials.

1. Don't use wet or damaged materials.
2. Never apply any roofing materials during rain or snow, or to wet surfaces. Moisture trapped within the roofing system as a result of this can cause severe damage to the roof membrane and insulation. Any product that has moisture contamination or is wet should be removed and discarded.
3. Review the guidelines for application of roofing, roof insulations, coatings and accessories shown in the current JM Commercial Roofing Product Manual.
4. Always start application at the low edge of the roof per the individual specification diagram.
5. Good roofing procedure restricts the application of hot asphalt to a maximum of 6' (1.83 m) in front of the roll.
6. When using mechanical felt laying equipment, be sure that all orifices are open.
7. All roofing ply felts should be well broomed into the hot asphalt utilizing a broom or some other device.
8. Take special care when applying BUR coated felts in cold weather. Check the temperature of the asphalt at the mop, asphalt spreader, and cart to determine that it is at the proper application temperature.
9. Roll or scroll SBS modified bitumen sheets into a full mopping of hot asphalt. Back mopping and flopping into a full coating of asphalt is also acceptable for certain SBS products. SBS base sheets with polyester reinforcement must be allowed to relax in an unrolled position prior to installation.
10. Roll out and cut all thermoplastic fleece backed membranes to specified lengths and allow them to relax.
11. Do not mix different grades of asphalt or dilute asphalt with any material.
12. Heat the asphalt according to the manufacturer's recommendations. Check the temperature of the asphalt at the kettle and at the point of application. Have accurate thermometers on all roofing kettles. Adhere to the guidelines for the heating of asphalts in this section of the manual.
13. Always install water cutoffs at the end of each day's work to prevent moisture infiltration into the completed work area. Water cut-offs should be completely removed prior to resuming work.

14. Read the cold weather application procedures on page 2-20 of this section.
15. It is essential that traffic be minimized on a freshly laid roof, while the asphalt is still fluid. Asphaltic displacement through the porous fiber glass ply felts, SBS modified bitumen, and under the thermoplastic fleece backed membrane can result from rooftop traffic during asphalt "set" time. Depending on specific job factors, this set time can be as little as 45 minutes. Asphaltic displacement can result in "phantom" leaks and blistering of the membrane.
16. **Always comply with published safety procedures for all products being used. See the SDS and container labels for health and safety recommendations.**

Roofing Felts (Base and Ply Sheets)

JM manufactures different fiber glass roofing felts for a variety of roofing needs: vapor retarders, roof plies, base sheets and special felts for venting.

Roofing felts are furnished in rolls consisting of one or more squares. A "factory" square of roofing contains sufficient material to cover 100 ft² (9.29 m²) of roof surface accounting for nominal side and end laps.

For more information on these products, refer to Section 2 of the current JM Commercial Roofing Product Manual.

PVC Fleece-Backed

JM PVC Fleece Backed for hot asphalt application has a 8oz polyester fleece for staining protection against the asphalt. The membrane is furnished in 60 and 80 mil thickness and delivered in 76" or 144" widths. 60 mil membrane is 90' (27.43 m) long, and the 80 mil membrane is 75' (22.86 m).

Roofing Asphalts

JM BUR, SBS modified bitumen, and thermoplastic fleece back products are designed to be installed with hot asphalt (refer to the table on page 2-18).

PermaMop[®], coal tar pitch and coal tar asphalt are not permitted.

Asphalt can come from a variety of crude sources. Many of these sources produce high-quality mopping grade asphalts and many do not. Various physical properties of asphalts can affect the performance of the roofing system. For this reason, JM qualifies asphalt sources throughout the country and requires that only these asphalts be used to assure good performance and compatibility with the roofing products being used.

JM requires the use of approved asphalt within systems which require a JM Peak Advantage[®] Guarantee. These approved asphalts are periodically tested to assure conformance to both ASTM and JM asphalt specifications. For the names of approved asphalt suppliers in your area, contact a JM sales representative.

Health and Safety

See Section 1 of the JM Commercial Roofing Product Manual for health and safety information.

JM recommends the use of only two grades in BUR and SBS modified bitumen with thermoplastic fleece backed specifications — Type III and Type IV. The slope of the roof, as well as the climate, governs the grade of asphalt to be used. The success or failure of a roofing system depends greatly on the use of the proper grade of asphalt, as called for in the roofing specification.

Heating

Asphalts are susceptible to damage from overheating. Overheating, even for short periods, can "crack" or degrade the asphalt (a drop in softening point and slight oiliness is a symptom). Fall back in softening point can result in slippage of felts in the roofing system. As the softening point decreases, the viscosity or "holding power" of the interply asphalt decreases, resulting in slippage. If the overheating is more gradual, the asphalt may "age" prematurely, losing the beneficial light oils that help the roofing system weather and stay waterproof. Since asphalts are thermoplastic,

their viscosity varies with temperature. Application temperature must be in the range which will permit an adequate film of asphalt, whether applied by mop or machine. The JM Technical Center, in conjunction with the National Roofing Contractors Association (NRCA) and the Asphalt Roofing Manufacturing Association (ARMA), have been involved in considerable research developing guidelines for the proper heating and application of hot asphalt. These guidelines use the principle of Equiviscous Temperature (EVT).

In conjunction with these guidelines, the following information is printed on the cartons of asphalt, or on the bill of lading for asphalt shipments.

1. The Softening Point as determined by ASTM D 312.
2. The Minimum Flash Point (FP) of the asphalt as determined by ASTM D 92.
3. The Equiviscous Temperature. As currently defined by ASTM, this is the temperature at which the asphalt viscosity is 125 centistokes. Asphalt applied within $\pm 25^{\circ}\text{F}$ ($\pm 14^{\circ}\text{C}$) of the EVT at the point of application will provide a nominal 23-25 pounds of asphalt per 100 ft² (1.12 - 1.22 kg/m²).
4. The Finished Blowing Temperature (FBT). This is the temperature at which the blowing of the asphalt is completed.

NOTE: Work done by NRCA has shown that different EVT values should be used for mop-applied asphalt and machine-applied asphalt. Mop applied asphalt should be applied at an EVT based on 125 centipoise, while machine-applied asphalt should be applied using an EVT based on 75 centipoise. ASTM is currently evaluating incorporating this information into its specifications. Some asphalt suppliers are now including both EVT values on their product. If only the 125 centipoise (centistokes) value is provided, then for machine application, the asphalt should be applied at a 25°F (14°C) higher temperature than the 125 centipoise values. JM requires adherence to the following guidelines when the above information is furnished:

1. Use the proper softening point asphalt as specified for the roof slope, type of roofing system and climate.
2. For optimum application, the asphalt should be at the Equiviscous Temperature, $\pm 25^{\circ}\text{F}$ ($\pm 14^{\circ}\text{C}$), at the point of application. **However, SBS modified bitumen products require installation in asphalt with a minimum temperature of 400°F (204°C) at point of application.**
3. Never heat the asphalt to or above the Flash Point, to avoid danger of fire.
4. Heating above the Finished Blowing Temperature shall be strictly regulated, never for longer than four hours to preclude excessive asphalt degradation.

The characteristics per ASTM D 312 of the various grades of asphalt are as follows:

Product	ASTM Type	Softening Point		Flash Point
		Min.	Max.	C.O.C.** Min.
140°F (60°C) (dead level)	I	135°F (57°C)	151°F (66°C)	475°F (246°C)
170°F (77°C) (flat)	II	158°F (70°C)	176°F (80°C)	475°F (246°C)
190°F (88°C) (steep)	III	185°F (85°C)	205°F (96°C)	475°F (246°C)
220°F (104°C) (special steep)	IV	210°F (99°C)	225°F (107°C)	475°F (246°C)

** Cleveland Open Cup Method.

Penetration (dmm)

Product	32°F (0°C) 60 Sec. 200g.		77°F (25°C) 5 Sec. 100g.		115°F (46°C) @ 5 Sec. 77°F 50g.		Ductility (25°C) 5 cm/Min.
	Min.	Max.	Min.	Max.	Min.	Max.	
140°F (60°C)	3	—	18	60	90	180	10.0
170°F (77°C)	6	—	18	40	—	100	3.0
190°F (88°C)	6	—	15	35	—	90	2.5
220°F (104°C)	6	—	12	25	—	75	1.5

If Equiviscous Temperature is not available, nominal heating temperature guidelines of the asphalt are as follows:

Recommended Temperatures

Asphalt Type	Heating	Application for BUR
140°F (60°C)	425°F (218°C)	335°F to 405°F (168°C to 207°C)
170°F (77°C)	450°F (232°C)	350°F to 415°F (177°C to 213°C)
190°F (88°C)	500°F (260°C)	365°F to 435°F (185°C to 224°C)
220°F (104°C)	500°F (260°C)	400°F to 475°F (204°C to 246°C)

Use of insulated buckets, high boys, and circulating lines for cold weather application can help maintain a proper EVT when temperatures are low and the distance from the asphalt source to the point of application is great.

When asphalts are applied within the EVT temperature ranges, the proper amount of asphalt will be placed between the plies. The recommended quantity of asphalt has been indicated on each specification in the current JM Commercial Roofing Product Manual. Regardless of the exact quantity of asphalt applied, it is important that the asphalt be continuous, so felt does not touch felt, and that there be full adhesion between all plies of the system. JM considers a $\pm 25\%$ deviation from the asphalt quantity of 22 pounds per square listed to be acceptable.

Hot Asphalt Application

The BUR and SBS Modified Bitumen sheets must be firmly and uniformly placed in a full mopping of hot asphalt, without voids, and with all edges well sealed.

The thermoplastic fleece backed membrane must be firmly and uniformly placed in a full mopping of hot asphalt, without voids. **Asphalt must not be applied to the selvage edges of the thermoplastic fleece back membrane to allow a minimum 1.5" (38.1 mm) weld.** If the weld is not 1.5" (38.1 mm), then the entire seam must be stripped-in using a detail strip.

There are several application techniques that can be used when the asphalt is installed by mopping. The modified bitumen sheet can be rolled or flopped into the asphalt. Regardless of the application technique employed, the crucial factor is that the SBS modified bitumen sheets and thermoplastic fleece backed membrane make complete contact and embed in the hot asphalt. This can be accomplished by lightly brooming the modified bitumen sheet immediately after it has been



installed. It is also good roofing practice to “scuff in” the side and end laps to assure that they are completely sealed.

Rolling Technique

When rolling the modified bitumen sheet or the thermoplastic fleece backed membrane into the asphalt, the mechanic should mop no more than 6' (1.83 m) in front of the roll to ensure that the temperature of the asphalt does not cool and fall below the temperature necessary for good embedment. If the asphalt is allowed to cool too much, an inadequate bond may result. In addition, the viscosity of the asphalt increases, which can result in a wavy appearance or excessive quantities of asphalt. Excessive asphalt can increase the potential for slippage of the membrane. When using this application technique, brooming of the modified bitumen sheet and thermoplastic fleece backed membrane is especially important at the end of the sheet where there may not be sufficient weight from the roll to provide the necessary pressure to embed the sheet into the asphalt. Thermoplastic fleece backed roll is aligned and installed using typical hot asphalt technique.

Mechanically Applied Asphalt

The asphalt can be applied using a mechanical asphalt spreader, which can increase productivity. Some contractors have found that installing the material with a felt layer can also improve production.

Heat Welding Thermoplastic Fleece Backed Seams

This section describes welding and fastening methods used to install JM PVC roofing systems. Included: hot-air welding membrane sections, prefabricated JM PVC Coated Metal parts, and asphalt application of the membrane.

Before welding, ensure area is clean and dry. Remove dirt or contamination before welding by using low sudsing soap and water followed by membrane cleaner, or just membrane cleaner. As a last resort, cut away the affected sheet section and replace with new material. Hot air welding equipment is required to make all field seams. Welding speeds will be slower in high humidity conditions or at low temperatures.

Hot air welding works by applying very hot air to the membrane surfaces, softening and fusing the surfaces together, thereby creating a permanently fused, bonded sheet. One of the major advantages of hot air welding is the fact that the seam comes to full weld strength immediately.

Membranes can be hot air welded in many different conditions, including cold weather. A hand-held hot air welder is especially useful when welding membrane sections at corners or on vertical surfaces. Hand-held hot air welders are also used to weld membrane sections together or to weld membrane to JM PVC Coated Metal, which has factory-laminated PVC membrane on its top side and a protective coating on the back.

With either method, perform a test weld before beginning each day's application and any time the hot air welder has been turned off for any length of time to check peel strength, consistency, weld width, etc. and to adjust the welder. First, adjust the temperature of the hot air welder to produce a shiny membrane surface without burning the membrane. Fully insert the nozzle tip of the hot air welder into the seam, moving it slowly backwards. As the membrane softens, press the membrane surfaces together with a silicone rubber roller from the inside edge to the outside edge of the seam. Take care to produce a continuous weld with no air pockets.

If the membrane surface is overheated, a good weld cannot be achieved. The burned or discolored membrane must be patched. To repair a burned section, cut away the damaged material at least 1" (2.54 cm) beyond the burned edges. Patches should be cut to extend at least 3" (7.62 cm) beyond all damaged edges. Allow for a minimum 1½" (3.81 cm) weld width on all sides. Center the patch over

the cut area and weld to the membrane, using normal welding procedures. Cut all patches in a square or rectangular shape with round corners for a neat, finished roof appearance.

The T-joint occurs where three layers of membrane overlap. Voids may occur along the edge of the middle layer of membrane. To close the void, gently lift the upper membrane sheet and apply sufficient hot air to heat the membrane surfaces. Then, using the edge of a silicone rubber roller, roll and fuse the upper membrane surface into the lower membrane. A crease developed along the intersection of the two surfaces indicates a proper weld. JM recommends patching all T-joints – to include base flashing – using a JM PVC T-Joint Patch.

Hot air welded seams may be tested as soon as the seams cool. After welding, carefully test every seam and t-joint along its entire length. Do this by running a blunted scratch awl, cotter key puller, or other round-tipped blunted tool along the seam edge while applying firm, steady pressure. It is imperative to avoid scoring the membrane that has just been welded. Any penetration of the probe into the seam indicates a void in the weld which must be repaired.

Continuous seam probing will tend to sharpen the tip of the probe, so it is important to blunt the tip of the probe regularly. Test all welded seams for integrity and continuity before the end of each work day. In addition to probing, take seam samples to verify seam quality as necessary. Cut the samples across the seam 6" (15.24 cm) on each side of the seam and 2" (5.08 cm) wide. Peel these samples by hand to test seam strength. Good seams will be virtually impossible to peel and should delaminate the PVC film from the reinforcing scrim. Cut and test a minimum of one sample in the morning and when weather conditions change or after work interruptions when the automatic hot air welder has been shut off.

Cold Weather Application (Below 45°F [7°C])

General Instructions for Cold Weather Bituminous Installations

Roof applications utilizing asphalt below 45°F (7°C) require special measures to ensure proper performance of the roofing system. JM strongly recommends that the following guidelines be followed when applying built-up or SBS Modified bitumen membranes in cold weather:

1. Use extra care to ensure that any moisture is removed from the deck surface. The presence of moisture may cause poor adhesion or skips in the mopping asphalt which in turn can entrap moisture within the roofing system.
2. Store materials in a heated warehouse or closed and heated trailer immediately prior to installing.
3. Do not overheat the asphalt. Insulated asphalt lines and insulated rooftop equipment should be used. Set up job site equipment to minimize the distance between asphalt heating source and application point.
4. Do not mop more than 4' (1.22 m) ahead of the roll. Embed the rolls into the hot asphalt immediately.
5. Squeegee all fiber glass ply felts to ensure adhesion.
6. Install only as much roofing material as can be completed and covered in one day.
7. The use of temporary roofs should be strongly considered if construction schedules require roof applications in cold or rainy weather.

General Suggestions for Cold Weather PVC Fleece Backed Installation

1. Store all JM PVC materials in warm, dry area away from sparks and open flames, to avoid condensation problems which could affect weld quality.
2. Take at least twice the usual number of seam samples to test for peel resistance since the possibility of inferior welds is greater.

3. Thoroughly dry all weld surfaces prior to welding.
4. Exercise caution when walking on dew, frost, ice or snow covered roofs since the membrane may be extremely slippery.

7.0 Seaming, T-Joints, Penetrations, and Other Considerations

Membrane Seaming Methods

Before Welding

Visually inspect all hot air welders, both hand-held and robotic, for damage, loose parts or screws, and cleanliness. Check drive wheel and drive belt, pressure wheel, rear guide wheel, and all other mechanical parts. Motion testing of the robotic welder to ensure it is tracking straight should also be done before welder is used for membrane seaming.

Ensure you have a clean consistent power source for your hot air welders. Generators should not be used to power other tools when hot air welders are in use. The surging created by other power tools cycling on and off can cause inconsistencies in the final welded product. Often times a job site/facility power source is preferred. However, it is recommended that extension cord length does not exceed 100', which means generators may be required on some job sites.

Cut pieces of membrane to create test welds to ensure the settings of the robotic and hand-held welders are correctly configured to the current membrane and environmental conditions. Perform a 4' or 5' (1.22 m or 1.52 m) test weld before beginning each day's application and any time the hot air welder has been turned off for any length of time, to check peel strength, consistency, weld width, etc. Adjust the welder accordingly.

Make sure the membrane is clean and dry on both sides of the membrane to be welded. If dirt and/or contaminants are not removed by wiping membrane with a clean dry cotton cloth, JM Single Ply Membrane Cleaner may be used. If cleaner is used, give an appropriate amount for time for the solvents to completely flash off, approximately 5 minutes.

Hand-Held Hot Air Welding

After verifying the areas to be welded are clean and dry, seams are aligned with the minimum required overlap, and the welding equipment is set to the calibrated temperature setting; welding of the seam or flashing may begin.

1. Lift the top layer of membrane to insert the nozzle of the hand-held welder underneath with the end of the nozzle at a 45° angle to the seam.
2. Apply pressure with the 2" rubber/silicone roller, moving back and forth, parallel to the end of the nozzle, extending ½" past the nozzle in each direction.
3. Follow the hand-held hot air welder approximately ¼" – ½" behind the nozzle end as you continue down the weld in a smooth and consistent movement.

If you must stop in the middle of a weld for any reason make sure to pull on the last section of weld to release any cold or false welds. Then insert the nozzle back into the weld and continue as described above.



Robotic Hot Air Welding

Robotic hot air welders provide many performance advantages over hand-held hot air welders but their larger size and directionality do not make them applicable in all situations. Several advantages are consistent speed of weld, constant pressure on welded area, higher powered heating element, built-in air dam, and repeatability. Field seams must be completed by a robotic hot air welder.

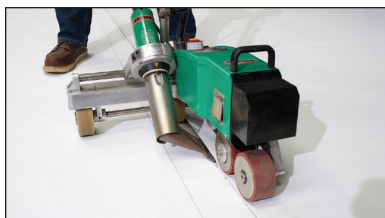

After verifying the areas to be welded are clean and dry, seams are aligned with the minimum required overlap, and the welding equipment is set to the calibrated temperature setting; welding of the seam or flashing may begin.

To begin the welding process, align the drive wheel of the welder onto the edge of the top layer of membrane, move the rear guide wheel onto the same edge of the top layer of membrane, and insert the 2" nozzle into the lap to be welded. Fully seating the nozzle in the lap should activate the automatic movement function of the robotic hot air welder.

NOTE: Use caution as the robotic hot air welder's direction of movement usually is in the backward walking direction for the operator. The assistance of a spotter and cord person is recommended.

Surface irregularities can cause the pressure wheel to move slightly away from the seam. If this happens, apply light pressure on the machine's upper handle to maintain travel in a straight line and keep even pressure of the drive wheel on the welded seam area. As the hot air nozzle moves along the weld area, the wide drive wheel behind the nozzle (relative to the direction of movement) applies immediate and uniform pressure to the heated seam area. Check all robotic hot air welded seams for voids and repair with a hand-held hot air welder before the end of each working day.

T-Joints

T-joints occur where three layers of membrane intersect. Voids may occur along the edge of the middle layer of membrane between the upper and lower layers of membrane. After the lower and middle layer of membrane have been welded:



In the case of hand welding:

1. To seal the void, gently lift the upper membrane sheet and apply sufficient hot air to heat both membrane surfaces.
2. Then, using the edge of a silicone rubber roller, roll and fuse the upper membrane surface into the lower membrane. A crease developed along the intersection of the two surfaces indicates a proper weld.

In the case of robotic welding:

1. To seal the void, when the robotic welder passes over the T-joint and the pressure wheel clears, use the edge of a silicone rubber roller to roll and fuse the upper membrane surface into the lower membrane. A crease developed along the intersection of the two surfaces indicates a proper weld.

Applying heat to the top side of the upper membrane sheet will not effectively fuse the two membranes together and will only damage the upper membrane sheet. JM recommends patching all T-joints — including base flashing — using a 4.5" (11.43 cm) rounded piece of detail membrane or JM PVC T-Joint Patch.

Repairing Scorched Membranes

If a section of the membrane surface is overheated, the burned or discolored membrane must be patched, as a good weld cannot be achieved.

1. To repair a scorched section, cut a patch in a square or rectangular shape with rounded corners. Patches should be cut to extend at least 3" (7.62 cm) beyond all damaged area. Allowing for a minimum 1.5" (3.81cm) weld width on all sides.
2. Center the patch over the cut area and weld to the membrane, using normal hand-held hot air welder procedures.

Reinforced membrane is to be used for patches on field membrane; non-reinforced membrane is to be utilized at areas requiring a tight contour or change in direction.

Probing Seams

Test all welded seams for integrity and continuity before the end of each work day.

Hot air welded seams may be tested as soon as the seams cool, testing prior to the cooling of the seam will cause damage to the membrane and the weld.

After the weld has cooled, carefully test every seam, t-joint, and patch along its entire length. Do this by running a blunted scratch awl, cotter key extractor or other round-tipped, blunted tool along the seam edge while applying firm, steady horizontal pressure. It is imperative to avoid scoring the membrane that has just been welded. Any penetration of the probe into the seam indicates a void in the weld, which must be repaired. Continuous seam probing will tend to sharpen the tip of the probe, so it is important to blunt the tip of the probe regularly.



Testing Seams

In addition to probing, take seam samples to verify seam quality as necessary.

Cut the samples across the seam 6" (15.24 cm) on each side of the seam and 2" (5.08 cm) wide. Peel these samples by hand to test seam strength. Good seams will be virtually impossible to peel, and should delaminate the PVC film from the reinforcing scrim. Cut and test a sample at the beginning of each day. Take additional test cuts when weather conditions change or after work interruptions when the automatic hot air welder has been shut off.

Sealing Tested Seams

Seal all cut seam edges with JM PVC Edge Sealant after testing and repairing. This prevents water from entering the welded area through wicking or capillary action. Weld and seal seams at all cut edges on the same day. Clean and dry any edges that stand overnight to ensure good sealant adhesion. Apply sealant with a squeeze bottle. Draw the tip smoothly along the cut edge of the membrane to produce a uniform 1/8" (3.18 mm) bead.

Flashings and Penetrations

Drains

There are several methods for flashing drains with JM PVC roofing membrane. The most common method is to taper insulation to the drain bowl creating a sump. A proper sump is created by using tapered panels, not shaving the edge of the insulation board around the drain.

1. Apply one tube of JM Single Ply Sealing Mastic around the drain bowl. Cut JM PVC Flashing Membrane to overlay drain area, and cut out hole in center area at least the same diameter as the drain leader. Cut holes one-half the size of bolt diameter at drain bolt penetrations. **Make sure there are no seams or fasteners through the drain clamping ring. Ideally, there should be no seams or fasteners in the drain sump. Add target patch if necessary.**

- Carefully press membrane drain flashing over drain bowl area and work into the mastic to form seal. Place metal clamping ring over membrane flashing so that bolt holes line up, and then tighten the bolts [See detail P-DV-07](#). Do not run fleece back membrane into the drain bowl. [See detail P-DV-09](#). The drain flashing membrane shall not be installed under tension or showing signs of ridging or deformation.

Vent Pipes

There are two primary methods for installing vent pipes in JM PVC roofing systems:

Method A. Installing Prefabricated Vent Pipe Boots:

[See Detail P-FP-01](#) JM PVC Pipe Boots are available to accommodate various diameters for installation over pipes.

Prior to pipe boot installation, remove any asphaltic deposits from vent pipes. Completely wrap any remaining asphalt with aluminum tape before plastic boot comes into contact with pipe. Bring the JM PVC field sheet up to the base of the pipe and fasten or secure with a minimum of four fasteners around the vent stack. If using the prefabricated pipe boot, place the boot over the pipe and weld continuously around the bottom lip of the boot. Ensure that pipe boot extends past outside edge of all fasteners by a minimum 1½" (3.81 cm).

Apply JM Single Ply Sealing Mastic behind the top of the pipe boot membrane before pulling draw band tight around the vent pipe. Apply JM Single Ply Caulk to the top of the draw band to seal against water intrusion.

See details [P-FP-04](#), [P-FP-05](#), and [P-FP-06](#) for pre-fabricated split pipe boots.

Method B, Sealing Pipe Base with JM PVC Flashing: [See Detail P-FP-07](#)

- Prepare a square JM PVC Detail Membrane target patch to overlap the securement plate edges by at least 4" (10.16 cm), to accommodate sheet movement and a 1½" (3.81 cm) weld width. Round off all corners. Cut a hole in the center of the membrane that is about two-thirds of the diameter of the pipe. Center hole over the pipe; heat area around the hole with a heat welder, and stretch fit membrane over the pipe to create a 1" (2.54 cm) turn-up, with the collar seated flush on the deck.
- Weld the membrane collar continuously to the field sheet and/or the metal collar. Field wrap JM PVC Detail Membrane around the pipe stand and adhere to the vent pipe, while flanging the bottom of the field wrap. Extend field wrap flange at least 1" (2.54 cm) onto the membrane stretch collar and weld continuously to the collar. If the pipe has asphalt or other contaminants on it, it must be cleaned and wrapped completely with aluminum tape before installing the flashing.

Penetration Pockets

Penetration pockets are used to seal around irregular shaped penetrations through the roofing system that do not allow for previously mentioned flashing methods.

[See Detail P-FP-02](#) JM PVC Penetration Pockets are one-piece molded pockets with a rigid vertical wall and preformed flange. Field-fabricated penetration pockets are also available, typically fabricated from JM PVC-Coated Metal. [See Detail P-FP-03](#).

Leave an open, overlapped seam at the center of one side so the penetration pocket may be spread around penetrations before final riveting. Minimum Field Fabricated PVC Clad penetration pocket height is 4" (10.16 cm).

Fasten penetration pocket flanges at the outside to the deck or nailer. The overlap or opening must be covered with aluminum tape and detail membrane prior to stripping flange. With strips of JM PVC Detail Membrane, strip in penetration pocket around all four sides, and weld continuously to JM PVC-Coated Metal as you would a field sheet. Seal all cut edges with JM PVC Edge Sealant. JM PVC



Primer must be applied to the inside surfaces of the JM penetration pocket or fabricated pitch pan.

Using JM PVC Pourable Sealer, fill until mounded above penetration pocket and slope from pipe to penetration pocket edges to shed water (no ponding water should be present in penetration pocket). Fasten penetration pockets greater than 18" x 18" (45.72 cm x 45.72 cm) to nailers securely anchored to the deck.

JM PVC-Coated Metal Flashing

[Reference details P-FE-CM for coated metal perimeter edge flashings.](#) Preformed JM PVC-Coated Metal Flashing is fastened around the roof perimeter edge. Welding the membrane to JM PVC-Coated Metal Flashings at these points provides a watertight seal.

JM PVC-Coated Metal Flashing is manufactured in 10' (3.05 m) lengths. Leave a $\frac{3}{8}$ " to $\frac{1}{2}$ " (9.53 mm to 1.27 cm) maximum gap between each length to allow for thermal expansion. Aluminum tape should be applied over all joints in JM PVC-Coated Metal prior to heat welding the joint covers and membrane in place.

[Reference detail P-FE-CM6.](#)

Gravel Stops and Drip Edge

[Reference P-FE-CM1 for drip edge](#), and [P-FE-CM3 for gravel stop](#). The top of the gravel stop must be at least $\frac{1}{2}$ " (3.81 cm) above the nailer height. This may vary, depending on roof conditions. The bottom edge of the flashing should extend at least 1" (2.54 cm) below the nailer on the vertical fascia surface.

If the vertical gravel stop face exceeds 4" (10.16 cm), fasten per the job specifications, but not less than a 20-gauge to 24-gauge (0.91 mm to 0.61 mm), continuous galvanized steel clip on the fascia. Use lengths of gravel stop to quickly position each cleat.

Fasten the gravel stop to the wood nailer with roofing nails spaced 6" (15.24 cm) o.c. and staggered. Leave a $\frac{3}{8}$ " to $\frac{1}{2}$ " (9.53 mm to 12.7 mm) gap for expansion between gravel stop lengths.

Apply aluminum tape to the joint prior to heat welding the joint covers and membrane in place.

Membrane Flashings

Install all membrane flashings at the same time as the roof membrane. Do not use temporary flashings. If water penetrates the flashings, immediately replace all affected materials.

Use only JM PVC adhered, mechanically attached, or prefabricated flashings, depending on job circumstances. Secure the mechanically attached flashings to the parapet wall at a maximum vertical distance of 18" (45.72 cm) o.c., and horizontally to the parapet at maximum spacing of 12" (30.48 cm) o.c. All adhered surfaces must be compatible with JM PVC roofing membranes. [See detail P-FW-M11](#) to view which substrates are compatible. If existing asphalt flashing remains, then $\frac{1}{4}$ " Invinsa[®], $\frac{15}{32}$ " (1.91 cm) thick plywood, $\frac{9}{16}$ " (1.43 cm) OSB, gypsum, or 9 oz./yd² (0.31 kg/m²) polyester fleece must be secured to the asphaltic surface as a barrier before applying JM PVC Membrane Flashings. **Paper slip sheets are not acceptable for use as asphalt barriers.** Apply adhesive as noted in "Adhered Systems" in section 4.0 of this guide. **Do not apply adhesive to any flashing areas that will be welded. Do not use fleece back membrane for flashings.**

Water-based adhesive applications are not approved for vertical surfaces.

Extend all flashings a minimum of 8" (20.32 cm) above the roof level. Contact your JM Technical Services Specialist for recommendations if this cannot be done.

Terminate all JM PVC Membrane Flashings per the applicable detail.

Walkpads

If pavers are used as permanent walkways for maintaining rooftop equipment, use an additional layer of JM PVC Membrane or a layer of JM 9 oz./yd² (0.31 kg/m²) Polyester Mat Protection Slipsheet under paver blocks to protect the membrane.

Another walkway option on a mechanically fastened or adhered roof is to weld strips of JM PVC Walkpad or Heavy-Duty Walkpad material directly to the membrane. [See details P-PT-05, 06, & 07](#) and note that walkpads **must not be installed over field seams**. This material provides an almost continuous walkway, and is embossed for a skid-resistant surface. JM PVC Walkpad should be continuously welded to the membrane and checked for voids, which must be repaired with a heat welder. Continuously welding the walkway material will seal against water entry.

Adhered systems require walkpads to also be adhered.

Night Tie-Off

Apply water cutoffs to seal the edge of roofing layers at the end of the work day. If a cutoff is required on an existing gravel-surfaced roof, completely spud off the gravel for a watertight connection.

If JM PVC Membrane has been exposed for a period greater than 24 hours and/or compromised by dirt or debris, the area shall be removed or cleaned with JM Single Ply Membrane Cleaner prior to welding to ensure full weld strength.

3

JM PVC Mechanically Fastened Membrane Fastening Patterns

3

JM PVC Membrane Flashing Details



Download a free QR Reader app on your smart phone. When you see a QR code, use your phone to scan the code. It will then redirect your phone to a specific video or detail. These codes will allow you to view step by step instructional videos and will allow you to zoom in on details for better readability. If you are viewing this booklet online you can click on these codes to direct you to the online videos and details as well.

Disclaimer:

The PVC Roofing Systems Commercial Roofing Application Guide is intended as a guide only; actual conditions encountered during installation may vary from jobsite to jobsite. By providing this guidance, Johns Manville assumes no responsibility for quality of installation, field workmanship, building code compliance, or job safety. Johns Manville Material Safety Data Sheets (MSDS) are available with specific product safety information. For information on other Johns Manville thermal insulations and systems, call (800) 922-5922 or visit JM.com.

Mechanically Attached JM PVC - 6" O.C.

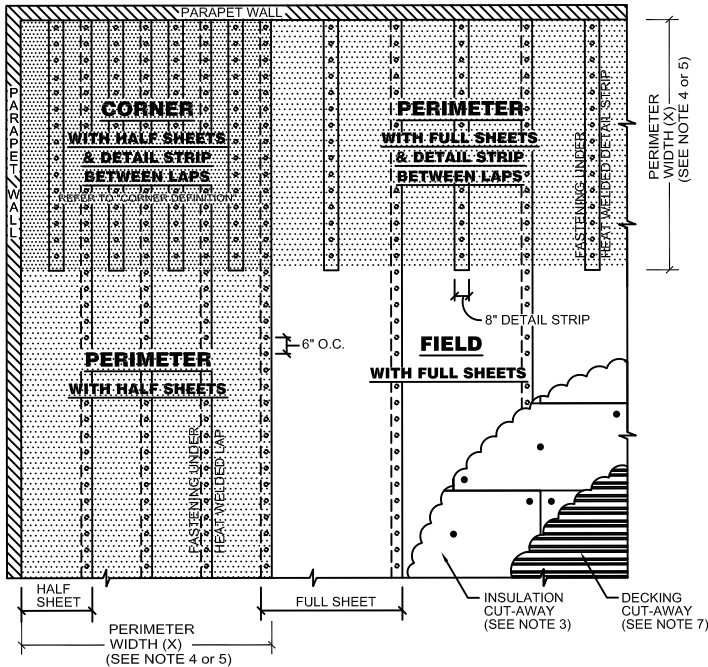

NOTES

1. CALCULATE UPLIFT DESIGN PRESSURES IN ACCORDANCE WITH ASCE-7.
2. FASTENING DIAGRAM IS BASED ON FM GLOBAL DATA SHEET 1-29.
3. INSTALL INSULATION WITH LONG JOINTS IN A CONTINUOUS STRAIGHT LINE WITH END JOINTS STAGGERED.
4. ROOF HEIGHT \leq 60 FT , THE PERIMETER (X) IS THE SMALLER DIMENSION OF:
 - 10% OF THE SHORTEST SIDE (PLAN VIEW)
 - OR
 - 40% OF THE ROOF HEIGHT,
 - BUT
 - NOT LESS THAN 4% OF THE SHORTEST SIDE (PLAN VIEW) OR 3 FEET.
5. ROOF HEIGHT > 60 FT , THE PERIMETER (X) IS:
 - 10% OF THE SHORTEST SIDE (PLAN VIEW) BUT NOT LESS THAN 3 FEET.
6. THE CORNERS MAY BE TREATED AS PERIMETERS IF THE PARAPET IS GREATER THAN OR EQUAL TO 3 FT ON ALL SIDES ACCORDING TO ASCE-7.
7. MEMBRANE SIDE LAPS MUST RUN PERPENDICULAR TO METAL DECK FLUTES.

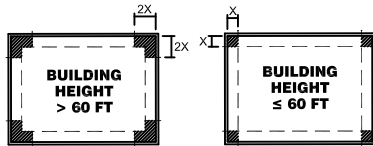
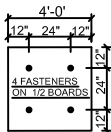
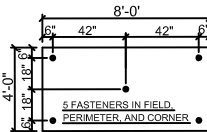

Johns Manville is a manufacturer of commercial roofing products and offers this general conceptual information to you as a courtesy. This complimentary assistance is not to be used or relied upon by anyone as a substitute for professional engineering design and documentation required by building code, contract, or applicable law. By accepting these comments you agree they do not constitute any representations, endorsements of, or an assumption by Johns Manville of any liability for either the adequacy of design of this building or any other material not supplied by Johns Manville.

Note: For the most current information on general guidelines, please refer to the System Considerations tab under Commercial Roofing Products on the JM Roofing Web site. For specifications, flashing details and general installation information please refer to the Application Tools tab.

Refer to the Safe Use Instructions and product label prior to using this product.

Mechanically Attached JM PVC - 6" O.C.

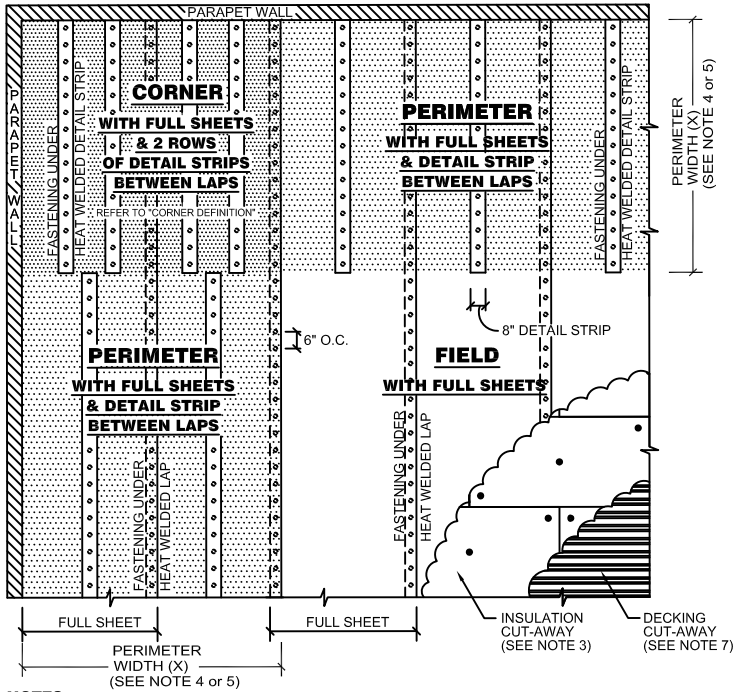

NOTES

1. CALCULATE UPLIFT DESIGN PRESSURES IN ACCORDANCE WITH ASCE-7.
2. FASTENING DIAGRAM IS BASED ON FM GLOBAL DATA SHEET 1-29.
3. INSTALL INSULATION WITH LONG JOINTS IN A CONTINUOUS STRAIGHT LINE WITH END JOINTS STAGGERED.
4. ROOF HEIGHT ≤ 60 FT THE PERIMETER (X) IS THE SMALLER DIMENSION OF:
 - 10% OF THE SHORTEST SIDE (PLAN VIEW)
 - OR
 - 40% OF THE ROOF HEIGHT,
 - BUT
 - NOT LESS THAN 4% OF THE SHORTEST SIDE (PLAN VIEW) OR 3 FEET.
5. ROOF HEIGHT > 60 FT, THE PERIMETER (X) IS:
 - 10% OF THE SHORTEST SIDE (PLAN VIEW) BUT NOT LESS THAN 3 FEET.
6. THE CORNERS MAY BE TREATED AS PERIMETERS IF THE PARAPET IS GREATER THAN OR EQUAL TO 3 FT ON ALL SIDES ACCORDING TO ASCE-7.
7. MEMBRANE SIDE LAPS MUST RUN PERPENDICULAR TO METAL DECK FLUTES.

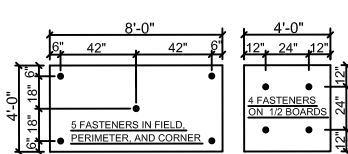

INSULATION FASTENING

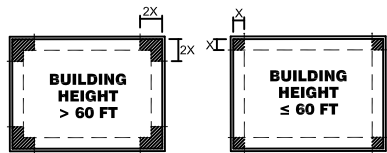

CORNER DEFINITION
(SEE NOTES 4.5 & 6)

Johns Manville is a manufacturer of commercial roofing products and offers this general conceptual information to you as a courtesy. This complimentary assistance is not to be used or relied upon by anyone as a substitute for professional engineering design and documentation required by building code, contract, or applicable law. By accepting these comments you agree they do not constitute any representations, endorsements of, or an assumption by Johns Manville of any liability for either the adequacy of design of this building or any other material not supplied by Johns Manville.

Note: For the most current information on general guidelines, please refer to the System Considerations tab under Commercial Roofing Products on the JM Roofing Web site. For specifications, flashing details and general installation information please refer to the Application Tools tab.

Refer to the Safe Use Instructions and product label prior to using this product.

Mechanically Attached JM PVC - 12" O.C.

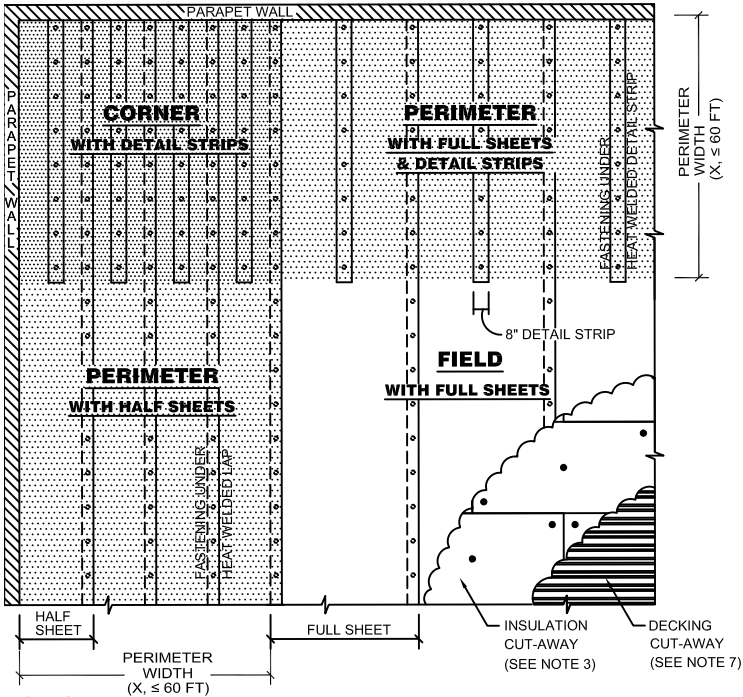

NOTES

1. CALCULATE UPLIFT DESIGN PRESSURES IN ACCORDANCE WITH ASCE-7.
2. FASTENING DIAGRAM IS BASED ON FM GLOBAL DATA SHEET 1-29.
3. INSTALL INSULATION WITH LONG JOINTS IN A CONTINUOUS STRAIGHT LINE WITH END JOINTS STAGGERED.
4. ROOFS UNDER 60 FT, THE PERIMETER (X) IS THE SMALLER DIMENSION OF:
10% OF THE SHORTEST SIDE (PLAN VIEW)
40% OF THE ROOF HEIGHT.
5. ROOFS OVER 60 FT, THE PERIMETER (X) IS:
10% OF THE SHORTEST SIDE (PLAN VIEW), ONLY.
6. THE CORNERS MAY BE TREATED AS PERIMETERS IF THE PARAPET IS GREATER THAN OR EQUAL TO 3 FT ACCORDING TO ASCE-7.
7. MEMBRANE SIDE LAPS MUST RUN PERPENDICULAR TO THE DECK.
8. FOR CUSTOMERS OUTSIDE OF THE U.S., METRIC FASTENING DIAGRAMS ARE AVAILABLE.

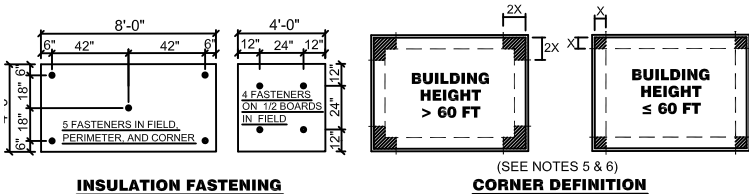

INSULATION FASTENING

CORNER DEFINITION

Johns Manville is a manufacturer of commercial roofing products and offers this general conceptual information to you as a courtesy. This complimentary assistance is not to be used or relied upon by anyone as a substitute for professional engineering design and documentation required by building code, contract, or applicable law. By accepting these comments you agree they do not constitute any representations, endorsements of, or an assumption by Johns Manville of any liability for either the adequacy of design of this building or any other material not supplied by Johns Manville.

Note: For the most current information on general guidelines, please refer to the System Considerations tab under Commercial Roofing Products on the JM Roofing Web site. For specifications, flashing details and general installation information please refer to the Application Tools tab.

Refer to the Safe Use Instructions and product label prior to using this product.

Mechanically Attached JM PVC - 12" O.C.

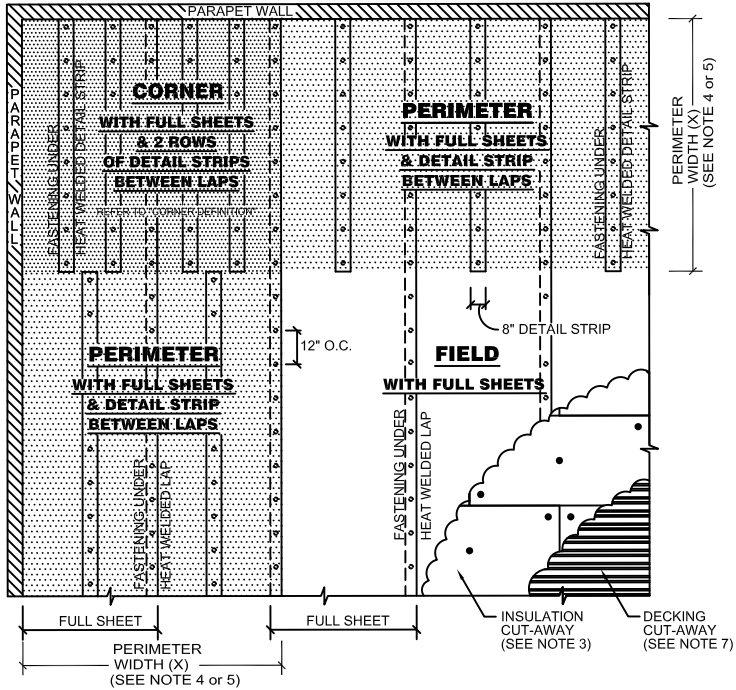

NOTES

- CALCULATE UPLIFT DESIGN PRESSURES IN ACCORDANCE WITH ASCE-7.
- FASTENING DIAGRAM IS BASED ON FM GLOBAL DATA SHEET 1-29.
- INSTALL INSULATION WITH LONG JOINTS IN A CONTINUOUS STRAIGHT LINE WITH END JOINTS STAGGERED.
- ROOF HEIGHT ≤ 60 FT , THE PERIMETER (X) IS THE SMALLER DIMENSION OF:
 - 10% OF THE SHORTEST SIDE (PLAN VIEW)
 - OR
 - 40% OF THE ROOF HEIGHT,
 - BUT
 - NOT LESS THAN 4% OF THE SHORTEST SIDE (PLAN VIEW) OR 3 FEET.
- ROOF HEIGHT > 60 FT , THE PERIMETER (X) IS:
 - 10% OF THE SHORTEST SIDE (PLAN VIEW) BUT NOT LESS THAN 3 FEET.
- THE CORNERS MAY BE TREATED AS PERIMETERS IF THE PARAPET IS GREATER THAN OR EQUAL TO 3 FT ON ALL SIDES ACCORDING TO ASCE-7.
- MEMBRANE SIDE LAPS MUST RUN PERPENDICULAR TO METAL DECK FLUTES.

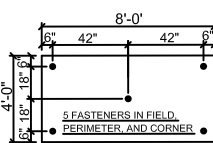

INSULATION FASTENING

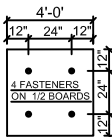

CORNER DEFINITION

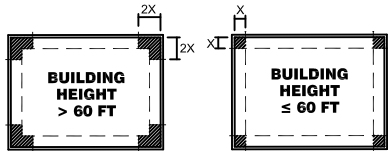

(SEE NOTES 4, 5 & 6)

Johns Manville is a manufacturer of commercial roofing products and offers this general conceptual information to you as a courtesy. This complimentary assistance is not to be used or relied upon by anyone as a substitute for professional engineering design and documentation required by building code, contract, or applicable law. By accepting these comments you agree they do not constitute any representations, endorsements of, or an assumption by Johns Manville of any liability for either the adequacy of design of this building or any other material not supplied by Johns Manville.

Note: For the most current information on general guidelines, please refer to the System Considerations tab under Commercial Roofing Products on the JM Roofing Web site. For specifications, flashing details and general installation information please refer to the Application Tools tab.

Refer to the Safe Use Instructions and product label prior to using this product.

Mechanically Attached JM PVC - 18" O.C.

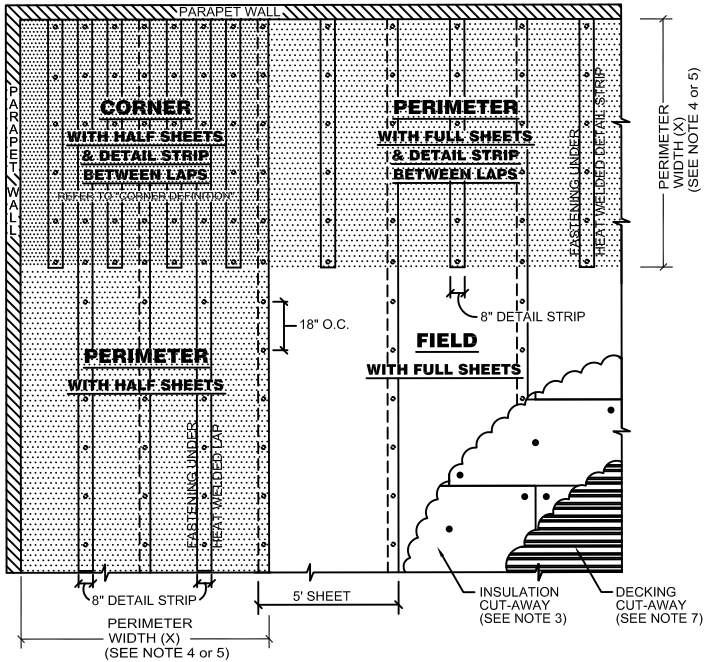

NOTES

- CALCULATE UPLIFT DESIGN PRESSURES IN ACCORDANCE WITH ASCE-7.
- FASTENING DIAGRAM IS BASED ON FM GLOBAL DATA SHEET 1-29.
- INSTALL INSULATION WITH LONG JOINTS IN A CONTINUOUS STRAIGHT LINE WITH END JOINTS STAGGERED.
- ROOF HEIGHT ≤ 60 FT , THE PERIMETER (X) IS THE SMALLER DIMENSION OF:
 - 10% OF THE SHORTEST SIDE (PLAN VIEW)
 - OR
 - 40% OF THE ROOF HEIGHT,
 - BUT
 - NOT LESS THAN 4% OF THE SHORTEST SIDE (PLAN VIEW) OR 3 FEET.
- ROOF HEIGHT > 60 FT , THE PERIMETER (X) IS:
 - 10% OF THE SHORTEST SIDE (PLAN VIEW) BUT NOT LESS THAN 3 FEET.
- THE CORNERS MAY BE TREATED AS PERIMETERS IF THE PARAPET IS GREATER THAN OR EQUAL TO 3 FT ON ALL SIDES ACCORDING TO ASCE-7.
- MEMBRANE SIDE LAPS MUST RUN PERPENDICULAR TO METAL DECK FLUTES.

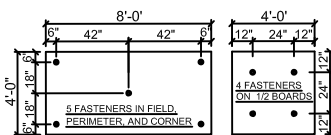

INSULATION FASTENING

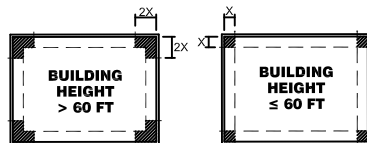

(SEE NOTES 4, 5 & 6)

CORNER DEFINITION

Johns Manville is a manufacturer of commercial roofing products and offers this general conceptual information to you as a courtesy. This complimentary assistance is not to be used or relied upon by anyone as a substitute for professional engineering design and documentation required by building code, contract, or applicable law. By accepting these comments you agree they do not constitute any representations, endorsements of, or an assumption by Johns Manville of any liability for either the adequacy of design of this building or any other material not supplied by Johns Manville.

Note: For the most current information on general guidelines, please refer to the System Considerations tab under Commercial Roofing Products on the JM Roofing Web site. For specifications, flashing details and general installation information please refer to the Application Tools tab.

Refer to the Safe Use Instructions and product label prior to using this product.

JM PVC RhinoPlate Fastening System - 6

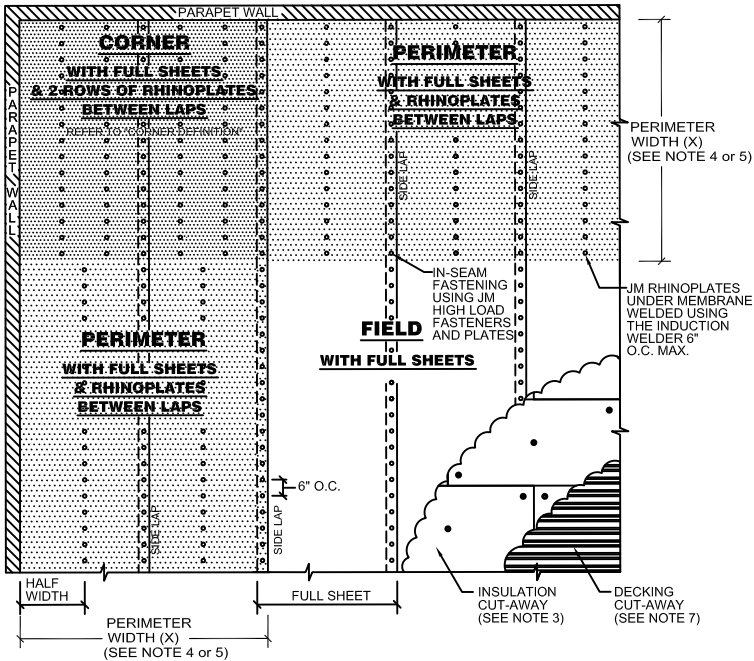

NOTES

- CALCULATE UPLIFT DESIGN PRESSURES IN ACCORDANCE WITH ASCE-7.
- INSTALL INSULATION WITH LONG JOINTS IN A CONTINUOUS STRAIGHT LINE WITH END JOINTS STAGGERED.
- ROOF HEIGHT ≤ 60 FT. THE PERIMETER (X) IS THE SMALLER DIMENSION OF:
 - 10% OF THE SHORTEST SIDE (PLAN VIEW)
 - OR
 - 40% OF THE ROOF HEIGHT,
 - BUT
 - NOT LESS THAN 4% OF THE SHORTEST SIDE (PLAN VIEW) OR 3 FEET.
- ROOF HEIGHT > 60 FT. THE PERIMETER (X) IS:
 - 10% OF THE SHORTEST SIDE (PLAN VIEW) BUT NOT LESS THAN 3 FEET.
- THE CORNERS MAY BE TREATED AS PERIMETERS IF THE PARAPET IS GREATER THAN OR EQUAL TO 3 FT ON ALL SIDES ACCORDING TO ASCE-7.
- MEMBRANE SIDE LAPS MUST RUN PERPENDICULAR TO METAL DECK FLUTES.

INSULATION FASTENING

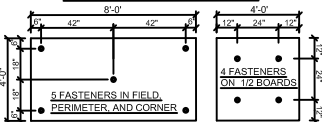

CORNER DEFINITION

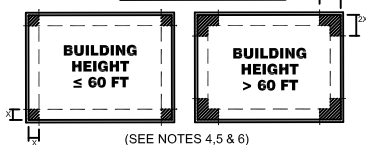

(SEE NOTES 4, 5 & 6)

Johns Manville is a manufacturer of commercial roofing products and offers this general conceptual information to you as a courtesy. This complimentary assistance is not to be used or relied upon by anyone as a substitute for professional engineering design and documentation required by building code, contract, or applicable law. By accepting these comments you agree they do not constitute any representations, endorsements of, or an assumption by Johns Manville of any liability for either the adequacy of design of this building or any other material not supplied by Johns Manville.

Note: For the most current information on general guidelines, please refer to the System Considerations tab under Commercial Roofing Products on the JM Roofing Web site. For specifications, flashing details and general installation information please refer to the Application Tools tab.

Refer to the Safe Use Instructions and product label prior to using this product.

JM PVC RhinoPlate Fastening System - 12

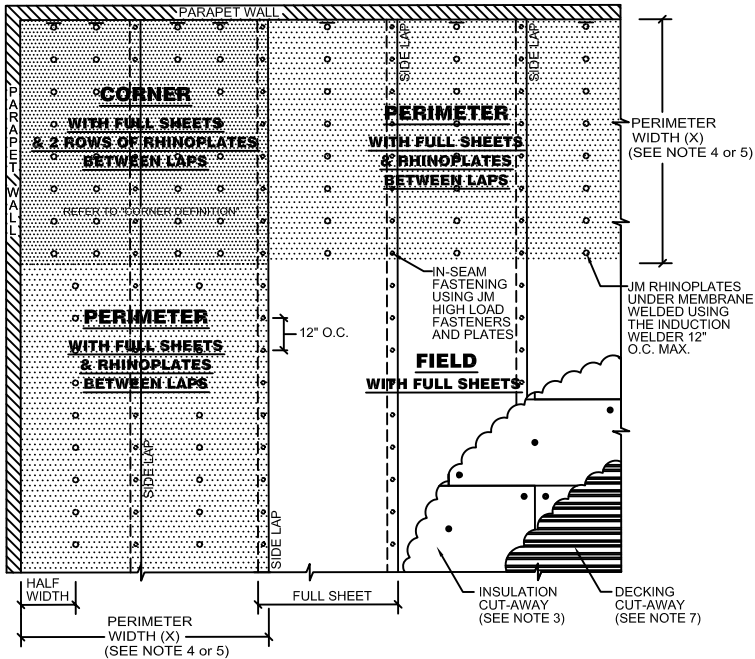

NOTES

1. CALCULATE UPLIFT DESIGN PRESSURES IN ACCORDANCE WITH ASCE-7.
2. INSTALL INSULATION WITH LONG JOINTS IN A CONTINUOUS STRAIGHT LINE WITH END JOINTS STAGGERED.
3. ROOF HEIGHT ≤ 60 FT. THE PERIMETER (X) IS THE SMALLER DIMENSION OF:
 - 10% OF THE SHORTEST SIDE (PLAN VIEW)
 - OR
 - 40% OF THE ROOF HEIGHT, BUT
 - NOT LESS THAN 4% OF THE SHORTEST SIDE (PLAN VIEW) OR 3 FEET.
4. ROOF HEIGHT > 60 FT. THE PERIMETER (X) IS:
 - 10% OF THE SHORTEST SIDE (PLAN VIEW) BUT NOT LESS THAN 3 FEET.
5. THE CORNERS MAY BE TREATED AS PERIMETERS IF THE PARAPET IS GREATER THAN OR EQUAL TO 3 FT ON ALL SIDES ACCORDING TO ASCE-7.
6. MEMBRANE SIDE LAPS MUST RUN PERPENDICULAR TO METAL DECK FLUTES.

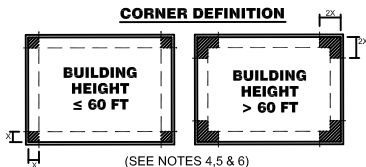
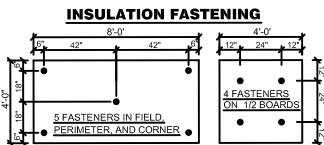

Johns Manville is a manufacturer of commercial roofing products and offers this general conceptual information to you as a courtesy. This complimentary assistance is not to be used or relied upon by anyone as a substitute for professional engineering design and documentation required by building code, contract, or applicable law. By accepting these comments you agree they do not constitute any representations, endorsements of, or an assumption by Johns Manville of any liability for either the adequacy of design of this building or any other material not supplied by Johns Manville.

Note: For the most current information on general guidelines, please refer to the System Considerations tab under Commercial Roofing Products on the JM Roofing Web site. For specifications, flashing details and general installation information please refer to the Application Tools tab.

Refer to the Safe Use Instructions and product label prior to using this product.

JM PVC RhinoPlate Fastening System - 6,8,8

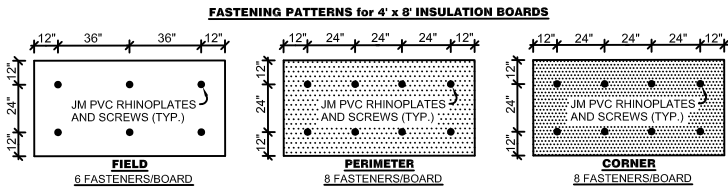
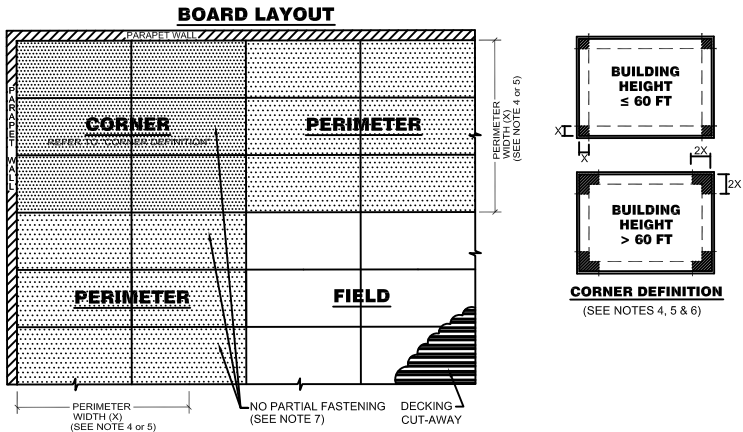

GENERAL NOTES

JM PVC MEMBRANE IS HEAT WELDED TO JM PVC RHINOPLATES USING THE RHINO-BOND TOOL.

ALL FASTENERS MUST PENETRATE HIGH RIB OF DECK.

UPLIFT NOTES

- CALCULATE UPLIFT DESIGN PRESSURES IN ACCORDANCE WITH ASCE-7.
- INSTALL INSULATION WITH LONG JOINTS AND END JOINTS IN A CONTINUOUS STRAIGHT LINE IN ORDER TO CREATE A LINEAR FASTENING PATTERN. MULTIPLE LAYERS OF INSULATION ARE TO BE STAGGERED.
- ROOF HEIGHT \leq 60 FT., THE PERIMETER (X) IS THE SMALLER DIMENSION OF:
 - 10% OF THE SHORTEST SIDE (PLAN VIEW)
 - OR
 - 40% OF THE ROOF HEIGHT.
 - BUT
 - NOT LESS THAN 4% OF THE SHORTEST SIDE (PLAN VIEW) OR 4 FEET.
- ROOF HEIGHT $>$ 60 FT., THE PERIMETER (X) IS:
 - 10% OF THE SHORTEST SIDE (PLAN VIEW) BUT NOT LESS THAN 4 FEET.
- THE CORNERS MAY BE TREATED AS PERIMETERS IF THE PARAPET IS GREATER THAN OR EQUAL TO 3 FT ON ALL SIDES ACCORDING TO ASCE-7.
- IF ANY PORTION OF THE BOARD LIES IN A PERIMETER OR CORNER ZONE. ENHANCE THE FASTENING OF ENTIRE BOARD.

Johns Manville is a manufacturer of commercial roofing products and offers this general conceptual information to you as a courtesy. This complimentary assistance is not to be used or relied upon by anyone as a substitute for professional engineering design and documentation required by building code, contract, or applicable law. By accepting these comments you agree they do not constitute any representations, endorsements of, or an assumption by Johns Manville of any liability for either the adequacy of design of this building or any other material not supplied by Johns Manville.

Note: For the most current information on general guidelines, please refer to the System Considerations tab under Commercial Roofing Products on the JM Roofing Web site. For specifications, flashing details and general installation information please refer to the Application Tools tab.

Refer to the Safe Use Instructions and product label prior to using this product.

JM PVC RhinoPlate Fastening System - 6,9,12

BOARD LAYOUT

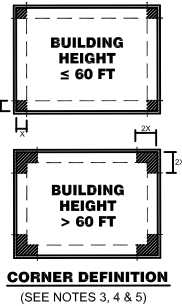
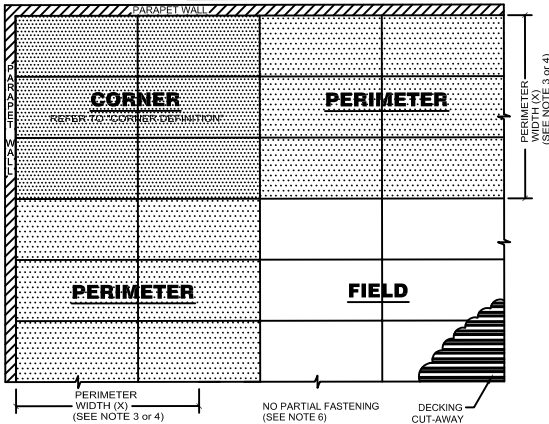

FASTENING PATTERNS for 4' x 8' INSULATION BOARDS

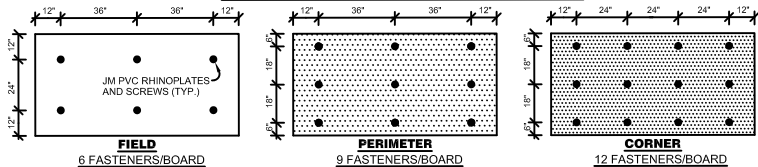

GENERAL NOTES

JM PVC MEMBRANE IS HEAT WELDED TO JM PVC RHINOPLATES USING THE RHINO BOND TOOL.

ALL FASTENERS MUST PENETRATE HIGH RIB OF DECK.

THE ABOVE FASTENING PATTERN ASSUMES THE PULLOUT TESTS ON FASTENERS ACHIEVE A 480 POUND PULLOUT VALUE.

UPLIFT NOTES

- CALCULATE UPLIFT DESIGN PRESSURES IN ACCORDANCE WITH ASCE-7.
- INSTALL INSULATION WITH LONG JOINTS AND END JOINTS IN A CONTINUOUS STRAIGHT LINE IN ORDER TO CREATE A LINEAR FASTENING PATTERN. MULTIPLE LAYERS OF INSULATION ARE TO BE STAGGERED.
- ROOF HEIGHT \leq 60 FT, THE PERIMETER (X) IS THE SMALLER DIMENSION OF:
 - 10% OF THE SHORTEST SIDE (PLAN VIEW)
 - OR
 - 40% OF THE ROOF HEIGHT,
 - BUT
 - NOT LESS THAN 4% OF THE SHORTEST SIDE (ELEVATION VIEW) OR 4 FEET.
- ROOF HEIGHT $>$ 60 FT THE PERIMETER (X) IS:
 - 10% OF THE SHORTEST SIDE (PLAN VIEW) BUT NOT LESS THAN 4 FEET.
- THE CORNERS MAY BE TREATED AS PERIMETERS IF THE PARAPET IS GREATER THAN OR EQUAL TO 3 FT ON ALL SIDES ACCORDING TO ASCE-7.
- IF ANY PORTION OF THE BOARD LIES IN A PERIMETER OR CORNER ZONE, ENHANCE THE FASTENING OF ENTIRE BOARD.

PVC Mechanically Fastened Membrane
Fastening Patterns
SECTION THREE

Johns Manville is a manufacturer of commercial roofing products and offers this general conceptual information to you as a courtesy. This complimentary assistance is not to be used or relied upon by anyone as a substitute for professional engineering design and documentation required by building code, contract, or applicable law. By accepting these comments you agree they do not constitute any representations, endorsements of, or an assumption by Johns Manville of any liability for either the adequacy of design of this building or any other material not supplied by Johns Manville.

Note: For the most current information on general guidelines, please refer to the System Considerations tab under Commercial Roofing Products on the JM Roofing Web site. For specifications, flashing details and general installation information please refer to the Application Tools tab.

Refer to the Safe Use Instructions and product label prior to using this product.

JM PVC RhinoPlate Fastening System - 6,10,15

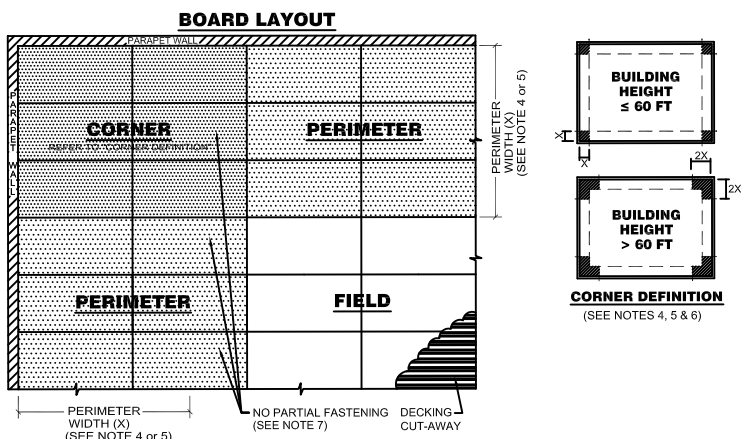

FASTENING PATTERNS for 4' x 8' INSULATION BOARDS

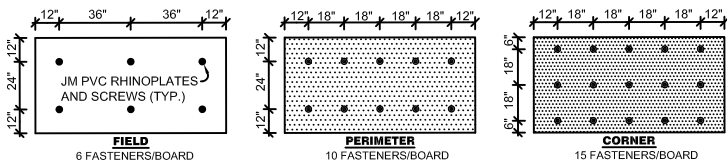

GENERAL NOTES

JM PVC MEMBRANE IS HEAT WELDED TO JM PVC RHINOPLATES USING THE RHINOBOND TOOL.

ALL FASTENERS MUST PENETRATE HIGH RIB OF DECK.

UPLIFT NOTES

- CALCULATE UPLIFT DESIGN PRESSURES IN ACCORDANCE WITH ASCE-7.
- FASTENING DIAGRAM IS BASED ON FM GLOBAL DATA SHEET 1-29.
- THIS MEMBRANE FASTENING PATTERN ACHIEVES AN FM 1-90 UPLIFT RATING OVER AN FM APPROVED DECK.
- INSTALL INSULATION WITH LONG JOINTS AND END JOINTS IN A CONTINUOUS STRAIGHT LINE IN ORDER TO CREATE A LINEAR FASTENING PATTERN. MULTIPLE LAYERS OF INSULATION ARE TO BE STAGGERED.
- ROOF HEIGHT \leq 60 FT, THE PERIMETER (X) IS THE SMALLER DIMENSION OF: 10% OF THE SHORTEST SIDE (PLAN VIEW) OR 40% OF THE ROOF HEIGHT, BUT NOT LESS THAN 4% OF THE SHORTEST SIDE (PLAN VIEW) OR 4 FEET.
- ROOF HEIGHT $>$ 60 FT, THE PERIMETER (X) IS: 10% OF THE SHORTEST SIDE (PLAN VIEW) BUT NOT LESS THAN 4 FEET.
- THE CORNERS MAY BE TREATED AS PERIMETERS IF THE PARAPET IS GREATER THAN OR EQUAL TO 3 FT ON ALL SIDES ACCORDING TO ASCE-7.
- IF ANY PORTION OF THE BOARD LIES IN A PERIMETER OR CORNER ZONE, ENHANCE THE FASTENING OF ENTIRE BOARD.

Johns Manville is a manufacturer of commercial roofing products and offers this general conceptual information to you as a courtesy. This complimentary assistance is not to be used or relied upon by anyone as a substitute for professional engineering design and documentation required by building code, contract, or applicable law. By accepting these comments you agree they do not constitute any representations, endorsements of, or an assumption by Johns Manville of any liability for either the adequacy of design of this building or any other material not supplied by Johns Manville.

Note: For the most current information on general guidelines, please refer to the System Considerations tab under Commercial Roofing Products on the JM Roofing Web site. For specifications, flashing details and general installation information please refer to the Application Tools tab.

Refer to the Safe Use Instructions and product label prior to using this product.

JM PVC RhinoPlate Fastening System - 8,12,16

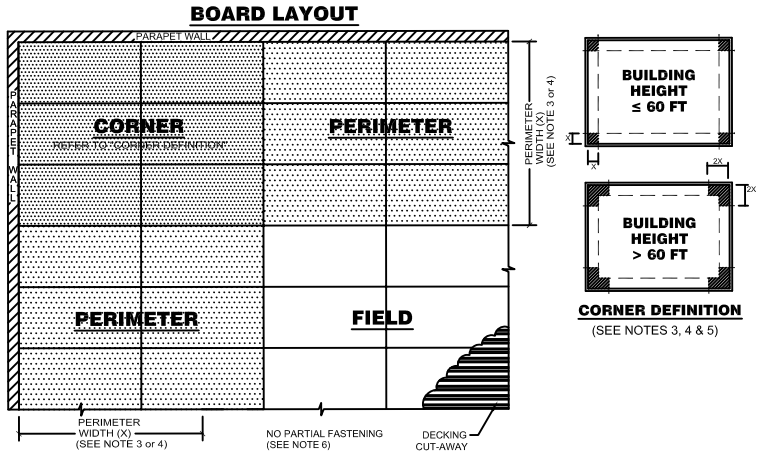

GENERAL NOTES

JM PVC MEMBRANE IS HEAT WELDED TO JM PVC RHINOPLATES USING THE RHINOBOND TOOL.
ALL FASTENERS MUST PENETRATE HIGH RIB OF DECK.

UPLIFT NOTES

- CALCULATE UPLIFT DESIGN PRESSURES IN ACCORDANCE WITH ASCE-7.
- FASTENING DIAGRAM IS BASED ON FM GLOBAL DATA SHEET 1-29.
- INSTALL INSULATION WITH LONG JOINTS AND END JOINTS IN A CONTINUOUS STRAIGHT LINE IN ORDER TO CREATE A LINEAR FASTENING PATTERN. MULTIPLE LAYERS OF INSULATION ARE TO BE STAGGERED.
- ROOF HEIGHT ≤ 60 FT, THE PERIMETER (X) IS THE SMALLER DIMENSION OF:
 - 10% OF THE SHORTEST SIDE (PLAN VIEW)
 - OR
 - 40% OF THE ROOF HEIGHT,
 - BUT
 - NOT LESS THAN 4% OF THE SHORTEST SIDE.** (PLAN VIEW) OR 4 FEET.
- ROOF HEIGHT > 60 FT, THE PERIMETER (X) IS:
 - 10% OF THE SHORTEST SIDE (PLAN VIEW) BUT NOT LESS THAN 4 FEET.
- THE CORNERS MAY BE TREATED AS PERIMETERS IF THE PARAPET IS GREATER THAN OR EQUAL TO 3 FT ON ALL SIDES ACCORDING TO ASCE-7.
- IF ANY PORTION OF THE BOARD LIES IN A PERIMETER OR CORNER ZONE, ENHANCE THE FASTENING OF ENTIRE BOARD.

Johns Manville is a manufacturer of commercial roofing products and offers this general conceptual information to you as a courtesy. This complimentary assistance is not to be used or relied upon by anyone as a substitute for professional engineering design and documentation required by building code, contract, or applicable law. By accepting these comments you agree they do not constitute any representations, endorsements of, or an assumption by Johns Manville of any liability for either the adequacy of design of this building or any other material not supplied by Johns Manville.

Note: For the most current information on general guidelines, please refer to the System Considerations tab under Commercial Roofing Products on the JM Roofing Web site. For specifications, flashing details and general installation information please refer to the Application Tools tab.

Refer to the Safe Use Instructions and product label prior to using this product.

JM PVC RhinoPlate Fastening System - 8,15,20

BOARD LAYOUT

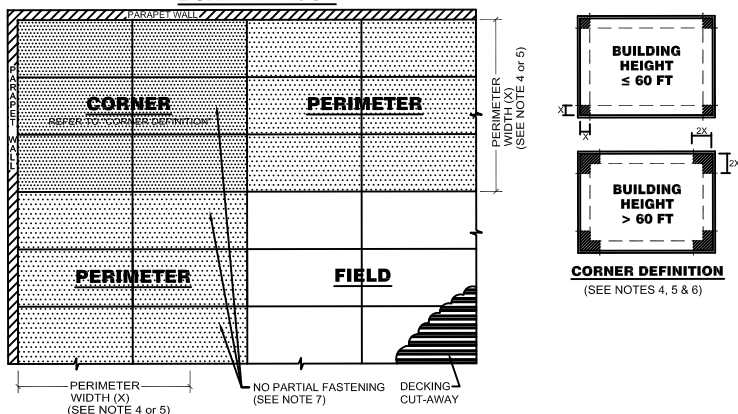

FASTENING PATTERNS for 4' x 8' INSULATION BOARDS

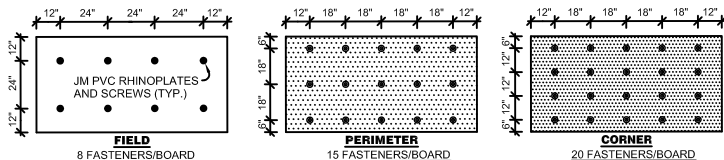

GENERAL NOTES

JM PVC MEMBRANE IS HEAT WELDED TO JM PVC RHINOPLATES USING THE RHINOBOND TOOL.

ALL FASTENERS MUST PENETRATE HIGH RIB OF DECK.

UPLIFT NOTES

- CALCULATE UPLIFT DESIGN PRESSURES IN ACCORDANCE WITH ASCE-7.
- FASTENING DIAGRAM IS BASED ON FM GLOBAL DATA SHEET 1-29.
- THIS MEMBRANE FASTENING PATTERN ACHIEVES AN FM 1-135 UPLIFT RATING OVER AN FM APPROVED DECK.
- INSTALL INSULATION WITH LONG JOINTS AND END JOINTS IN A CONTINUOUS STRAIGHT LINE IN ORDER TO CREATE A LINEAR FASTENING PATTERN. MULTIPLE LAYERS OF INSULATION ARE TO BE STAGGERED.
- ROOF HEIGHT ≤ 60 FT, THE PERIMETER (X) IS THE SMALLER DIMENSION OF:
 - 10% OF THE SHORTEST SIDE (PLAN VIEW)
 - OR
 - 40% OF THE ROOF HEIGHT,
 - BUT
 - NOT LESS THAN 4% OF THE SHORTEST SIDE (PLAN VIEW) OR 4 FEET.
- ROOF HEIGHT > 60 FT, THE PERIMETER (X) IS:
 - 10% OF THE SHORTEST SIDE (PLAN VIEW) BUT NOT LESS THAN 4 FEET.
- THE CORNERS MAY BE TREATED AS PERIMETERS IF THE PARAPET IS GREATER THAN OR EQUAL TO 3 FT ON ALL SIDES ACCORDING TO ASCE-7.
- IF ANY PORTION OF THE BOARD LIES IN A PERIMETER OR CORNER ZONE, ENHANCE THE FASTENING OF ENTIRE BOARD.

Johns Manville is a manufacturer of commercial roofing products and offers this general conceptual information to you as a courtesy. This complimentary assistance is not to be used or relied upon by anyone as a substitute for professional engineering design and documentation required by building code, contract, or applicable law. By accepting these comments you agree they do not constitute any representations, endorsements of, or an assumption by Johns Manville of any liability for either the adequacy of design of this building or any other material not supplied by Johns Manville.

Note: For the most current information on general guidelines, please refer to the System Considerations tab under Commercial Roofing Products on the JM Roofing Web site. For specifications, flashing details and general installation information please refer to the Application Tools tab.

Refer to the Safe Use Instructions and product label prior to using this product.

4

JM PVC Membrane Flashing Details

4

JM PVC Membrane Flashing Details



Download a free QR Reader app on your smart phone. When you see a QR code, use your phone to scan the code. It will then redirect your phone to a specific video or detail. These codes will allow you to view step by step instructional videos and will allow you to zoom in on details for better readability. If you are viewing this booklet online you can click on these codes to direct you to the online videos and details as well.

Disclaimer:

The PVC Roofing Systems Commercial Roofing Application Guide is intended as a guide only; actual conditions encountered during installation may vary from jobsite to jobsite. By providing this guidance, Johns Manville assumes no responsibility for quality of installation, field workmanship, building code compliance, or job safety. Johns Manville Material Safety Data Sheets (MSDS) are available with specific product safety information. For information on other Johns Manville thermal insulations and systems, call (800) 922-5922 or visit JM.com.

JM PVC Flashing Details

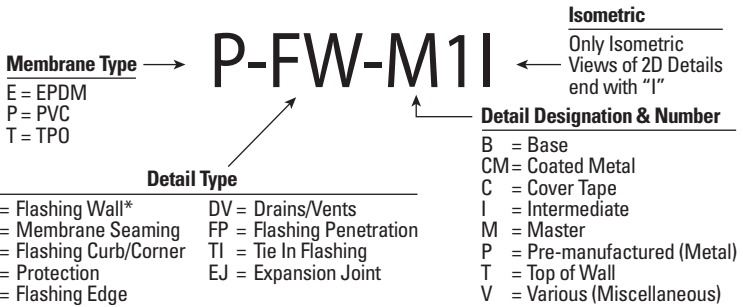

* Flashing Wall Details (FW) have Master Details (M) in both 2D and isometric that coordinate all the other Flashing Wall Details.

New Detail Number	Old Detail Number	Detail Description	Attachment		Page No.
			Method	MF AD	
<u>Master Details</u>					
P-FW-M1	New	PVC Base & Wall Flashing with Coping Master Detail	X	X	4-4
P-FW-M11	PW-35	PVC Base & Wall Flashing with Coping Isometric View Master Detail	X	X	4-5
P-FW-M21	PW-34	Highwall Flashing with Metal Backing Strip Isometric View Master Detail	X	X	4-6
<u>Base Tie-In Details</u>					
P-FW-B1	PB-26	Base Tie-In - Fastener & Plate	X	X	4-7
P-FW-B2	New	Base Tie-In - Fastener & Plate - On Wall	X	X	4-8
P-FW-B3	PB-26A	Membrane Flashing Base Tie-In - High Internal Pressure	X	X	4-9
P-FW-B4	PB-27	Base Tie-In - RhinoPlate System	X		4-10
P-FW-B5	New	Base Tie-In - Loose Hung Flashing	X		4-11
P-FW-B6	New	Base Tie-In Fleece Backed PVC In RSUA		X	4-12
P-FW-B6I	New	PVC Base Tie-In Fleece Backed In RSUA Base & Wall Flashing		X	4-13
<u>Intermediate Termination Details</u>					
P-FW-I1	PW-39	PVC Intermediate Membrane Attachment with Fastener & Plate	X	X	4-14
P-FW-I2	PW-32C	PVC Detail Strip Wall Flashing Attachment with Fastener & Plate	X	X	4-15
P-FW-I3	New	PVC Intermediate Membrane Attachment with Termination Bar	X	X	4-16
P-FW-I4	New	Termination Bar Flashing Attachment with Welded PVC Detail Strip	X	X	4-17
P-FW-I5	PW-32B	Continuous Flashing Attachment - Termination Bar	X	X	4-18
P-FW-I6	New	Split Flashing Attachment - Termination Bar	X	X	4-19
P-FW-I7	PC-40	PVC Intermediate Termination with Counterflashing & Cut-In Reglet	X	X	4-20
P-FW-I8	New	PVC Intermediate Termination with Surface Mounted Counterflashing	X	X	4-21
P-FW-I9	New	PVC Intermediate Termination with Thru Wall Counterflashing	X	X	4-22
P-FW-I10	PC-44	PVC Intermediate Termination with Termination Bar	X	X	4-23
P-FW-I11	New	PVC Intermediate Termination Below Wall Cladding	X	X	4-24
P-FW-I12	New	PVC Intermediate Membrane Attachment with Termination Bar	X	X	4-25
P-FW-I13	New	PVC Intermediate Termination - Loose Hung Flashing	X		4-26

New Detail Number	Old Detail Number	Detail Description	Attachment		Page No.
			Method	MF AD	
<u>Top of Wall Details</u>					
P-FW-T1	PC-47	Fabricated Metal Coping Over Adhered PVC	X	X	4-27
P-FW-T2	New	Presto Lock Coping System Over PVC	X	X	4-28
P-FW-T3	New	Presto-Tite Fascia System on Sloped Parapet	X	X	4-29
P-FW-T4	New	Perma-Tite Continuous Cleat Coping System Over PVC	X	X	4-30
<u>PVC Membrane Seaming Details</u>					
P-MS-01	New	Cut Edge Sealant	X	X	4-31
P-MS-02	PA-1	In Lap Fastening Method - Steel Deck	X		4-32
P-MS-03	PA-1A	In Lap Fastening Method - Plywood Deck	X		4-33
P-MS-04	PA-1B	In Lap Fastening Method - Concrete Deck	X		4-34
P-MS-05	PA-1C	In Lap Fastening Method - Wood Plank Deck	X		4-35
P-MS-06	PA-2	Continuous Strip Fastening Method	X		4-36
P-MS-07	PA-5	Membrane Side Lap	X	X	4-37
P-MS-08	PA-6	PVC Fleece Backed Adhesive Applied Membrane Butted End Lap	X	X	4-38
P-MS-09	PT-86	Slope Transition - Valley	X	X	4-39
P-MS-10	New	Slope Transition - Ridge	X	X	4-40
P-MS-11	P-MS-15	JM PVC Profile Attachment		X	4-41
P-MS-12	P-MS-16	JM PVC Standing Seam Profile Lap Joint		X	4-42
P-MS-13	P-MS-11	JM PVC Profile Spacing on 76" Fleece Backed Sheets		X	4-43
P-MS-14	P-MS-12	JM PVC Profile Spacing on 144" Fleece Backed Sheets		X	4-44
P-MS-15	P-MS-13	JM PVC Profile Spacing on 78" PVC Sheets		X	4-45
P-MS-16	P-MS-14	JM PVC Profile Spacing on 120" PVC Sheets		X	4-46
<u>PVC Flashing Curb & Corner Details</u>					
P-FC-01	PF-64	Prefabricated Metal Curb Base Flashing	X	X	4-47
P-FC-02	New	Roof Hatch	X	X	4-48
P-FC-03	PF-62A	PVC Outside Corner	X	X	4-49
P-FC-04	PF-63	PVC Inside Corner	X	X	4-50
P-FC-05	New	PVC Wood Curb Base Flashing	X	X	4-51
<u>PVC Protection Details</u>					
P-PT-01	PM-90	Support-Light	X	X	4-52
P-PT-02	PM-91	Support-Medium	X	X	4-53
P-PT-03	PM-92	Support-Heavy	X	X	4-54
P-PT-04	PM-94	Walkway-Concrete Paver	X	X	4-55
P-PT-05	PM-93A	PVC Walkpads Over Adhered PVC Membrane		X	4-56
P-PT-06	PM-98	PVC Walkpad Fleece Backed System Adhered		X	4-57
P-PT-07	TM-93M	PVC Walkpad Over Mechanically Fastened PVC Membrane	X		4-58
P-PT-08	New	Lightning Rod-Wall Mount	X	X	4-59
P-PT-09	PM-95 & 96	Lightning Rod-Roof Mount	X	X	4-60
P-PT-10	New	Grease Trap	X	X	4-61
P-PT-11	New	JM ENRGY Anchor - PVC	X		4-62
P-PT-12	New	JM PVC Safety Strip Over PVC Membrane	X	X	4-63
<u>PVC-Coated Metal Details</u>					
P-FE-CM1	PE-13	Drip Edge - PVC-Coated Metal	X	X	4-64
P-FE-CM2	New	Drip Edge - Adhered Membrane - PVC Coated Metal		X	4-65
P-FE-CM3	PE-11	Gravel Stop - PVC-Coated Metal	X	X	4-66
P-FE-CM4	New	Gravel Stop - Adhered Membrane Only - PVC Coated Metal		X	4-67
P-FE-CM5	PE-14	Gutter & PVC-Coated Metal Edge	X	X	4-68
P-FE-CM6	New	Butt Joint at Edge - PVC-Coated Metal	X	X	4-69
<u>Pre-Manufactured (Metal) Details</u>					
P-FE-P1	PE-12	JM Presto Lock Fascia System	X	X	4-70
P-FE-P2	PE-15	JM Presto-Tite Fascia System for Single Ply Systems	X	X	4-71
P-FE-P3	New	JM Rail Fascia System for Single Ply Roof	X	X	4-72
P-FE-P4	New	JM Perma-Tite System 200 Fascia Over PVC	X	X	4-73
P-FE-P5	New	JM Presto Weld Drip Edge	X	X	4-74

New Detail Number	Old Detail Number	Detail Description	Attachment		Page No.
			MF	AD	
<u>Various (Miscellaneous) Details</u>					
P-FE-V1	PA-4	Wood Nailer Attachment	X	X	4-75
P-FE-V2	New	Gutter & Termination Bar	X	X	4-76
P-FE-V3	PB-17	RhinoPlate - Standing Seam Retro-Fit Purlin Attachment	X		4-77
P-FE-V4	PE-18	RhinoPlate - Standing Seam Retro-Fit Gravel Stop	X		4-78
P-FE-V5	PE-19	RhinoPlate - Standing Seam Retro-Fit Gutter	X		4-79
<u>PVC Drains & Vents Details</u>					
P-DV-01	PF-52	Vent Pipe	X	X	4-80
P-DV-02	New	Vent Pipe - Hot	X	X	4-81
P-DV-03	PF-58	Through-Wall Scupper	X	X	4-82
P-DV-03I	New	Through-Wall Scupper	X	X	4-83
P-DV-04	PF-58A	Primary Scupper with Tapered Insulation Sump	X	X	4-84
P-DV-05	PF-58B	Low-Wall Primary Scupper Flashing	X	X	4-85
P-DV-06	PF-58C	Overflow Scupper	X	X	4-86
P-DV-07	PF-55	Primary Drain Sump - Low Slope - Up To 3:12 Slope	X	X	4-87
P-DV-08	New	Primary Drain Sump - Steep Slope - Greater Than 3:12 Slope	X	X	4-88
P-DV-09	New	Primary Drain Sump - Fleece Backed Membrane	X	X	4-89
P-DV-09I	PF-65	PVC Fleece Backed Adhesive Applied Primary Drain In Sump	X	X	4-90
P-DV-10	New	JM PVC Alumaweld Drain	X	X	4-91
P-DV-11	New	Primary Drain Sump - Mechanically Fastened Membrane	X		4-92
<u>PVC Flashing Penetration Details</u>					
P-FP-01	PF-50A	PVC Pipe Boot	X	X	4-93
P-FP-02	PF-54	PVC Coated Metal Penetration Pocket	X	X	4-94
P-FP-03	New	PVC Split Pipe Boot - Round	X	X	4-95
P-FP-04	New	PVC Split Pipe Boot - Square - Clamped	X	X	4-96
P-FP-05	New	PVC Split Pipe Boot - Square	X	X	4-97
P-FP-06	PF-51	Field Fabricated Pipe Penetration	X	X	4-98
P-FP-07	New	JM PVC Penetration Pan	X	X	4-99
<u>PVC Tie-In Flashing Details</u>					
P-TI-01	New	Transition for Staged Roofing - PVC-Coated Metal	X	X	4-100
P-TI-02	PT-82	Transition to Shingle Roof with PVC-Coated Metal	X	X	4-101
P-TI-03	PT-80	Curb Tie-In to Roof By Others	X	X	4-102
<u>PVC Expansion Joint Details</u>					
P-EJ-01	PT-70	Expansion Joint-Roof to Wall	X	X	4-103
P-EJ-02	PT-71	Expansion Joint-Roof to Roof	X	X	4-104
P-EJ-03	New	Expand-0-Flash Roof to Roof Expansion Joint Cover - Style PVC EJ/WC	X	X	4-105
P-EJ-04	New	Expand-0-Flash Roof to Wall - Style EJ	X	X	4-106
P-EJ-05	New	Expand-0-Flash Curb to Curb Expansion Joint Cover - Style PVC CF	X	X	4-107
P-EJ-06	New	Expand-0-Flash Curb to Wall Expansion Joint Cover - Style PVC CF/EJ	X	X	4-108
P-EJ-07	New	Expand-0-Flash Curb to Wall Expansion Joint Cover - Style PVC EJ/WC	X	X	4-109
P-EJ-08	New	Expand-0-Flash Curb to Curb Expansion Joint Cover - Style PVC EJ/WC	X	X	4-110
<u>Vapor Barrier SA Details</u>					
VB-1	New	JM Vapor Barrier SA - Wall Base Detail	X	X	4-111
VB-1(ALT)	New	JM Vapor Barrier SA - Wall Base Detail (ALT)	X	X	4-112
VB-2	New	JM Vapor Barrier SA - Pipe Penetration Detail	X	X	4-113
VB-3	New	JM Vapor Barrier SA - Drain Detail	X	X	4-114
VB-4	New	JM Vapor Barrier SA - Detail at Field Laps	X	X	4-115
VB-5	New	JM Vapor Barrier SA - Outside Curb Detail	X	X	4-116
VB-6	New	JM Vapor Barrier SA - Inside Curb Detail	X	X	4-117



PVC Base & Wall Flashing with Coping Master Detail

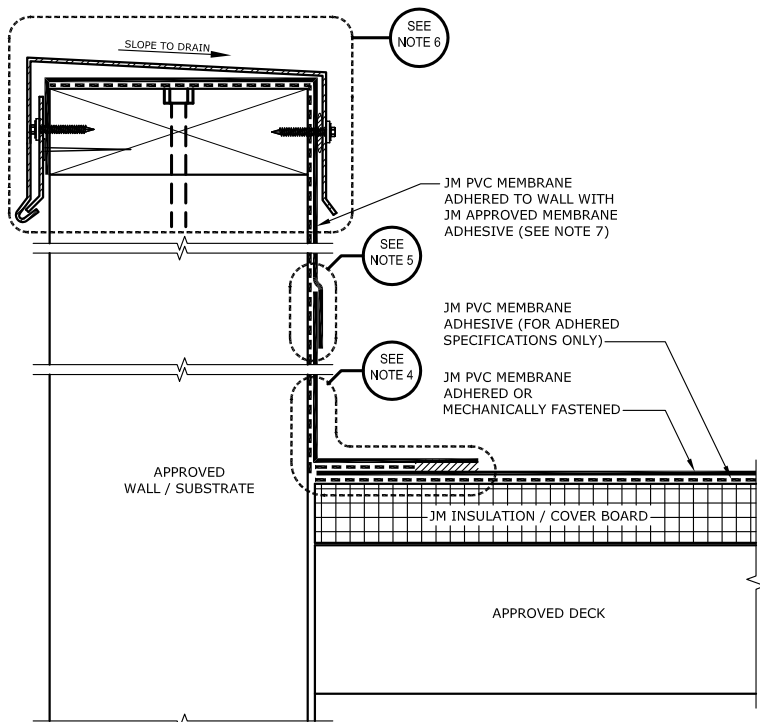

NOTES:

1. REFER TO JOHNS MANVILLE WEBSITE (www.jm.com) FOR MOST UP-TO-DATE INFORMATION.
2. PLEASE SEE SINGLE PLY FLASHING SPECIFICATIONS FOR A FULL DESCRIPTION OF INSTALLATION INSTRUCTIONS AND REQUIREMENTS WHICH ARE CONSIDERED A PART OF THIS DETAIL.
3. ANY CARPENTRY OR METAL WORK SHOULD BE DESIGNED AND CONSTRUCTED IN ACCORDANCE WITH LOCAL CODE REQUIREMENTS AND/OR PROJECT SPECS. THESE COMPONENTS SHOULD BE REVIEWED AND APPROVED BY A LICENSED DESIGN PROFESSIONAL.
4. FOR JM APPROVED BASE FLASHING FASTENING METHODS SEE P-FW-B DETAILS.
A SUFFICIENT BACKER FASTENING STRIP MUST BE INSTALLED BEHIND SUBSTRATES DIRECTLY TO STUDS FOR INSTALLATION OF TERMINATION BARS AND FLASHINGS WHEN SUBSTRATES WILL NOT SUPPORT A PROPER, SECURE INSTALLATION. SEE DETAIL P-FW-M2I FOR BACKER DETAIL.
5. FOR JM APPROVED INTERMEDIATE FLASHING FASTENING METHODS SEE P-FW-I DETAILS. MINIMUM FLASHING TERMINATION HEIGHT IS 8" (203 mm) ABOVE ROOF SURFACE. INTERMEDIATE ADHERED MEMBRANE FASTENING REQUIRED AT 5'-0" (1.52 m) INTERVALS MAXIMUM, AND 18" (457 mm) HIGH MAXIMUM FOR NON ADHERED MEMBRANE ON CMU, BRICK, SMOOTH CONCRETE WALLS, OR ANY JM APPROVED SUBSTRATE, I.E. PLYWOOD, SECUROCK® GYPSUM-FIBER AND DENSDECK®. SEE DETAIL P-FW-M2I FOR JM APPROVED FASTENING METHODS.
6. FOR JM APPROVED TOP OF WALL FLASHING METHODS SEE P-FW-T DETAILS.
7. JM APPROVED ADHESIVES FOR USE ON VERTICAL FLASHING APPLICATIONS INCLUDES JM PVC MEMBRANE ADHESIVE (LOW VOC) ONLY.

Johns Manville is a manufacturer of commercial roofing products and offers this general conceptual information to you as a courtesy. This complimentary assistance is not to be used or relied upon by anyone as a substitute for professional engineering design and documentation required by building code, contract, or applicable law. By accepting these comments you agree they do not constitute any representations, endorsements of, or an assumption by Johns Manville of any liability for either the adequacy of design of this building or any other material not supplied by Johns Manville.

Note: For the most current information on general guidelines, please refer to the System Considerations tab under Commercial Roofing Products on the JM Roofing Web site. For specifications, flashing details and general installation information please refer to the Application Tools tab.

Refer to the Safe Use Instructions and product label prior to using this product.



PVC Base & Wall Flashing with Coping Isometric View Master Detail

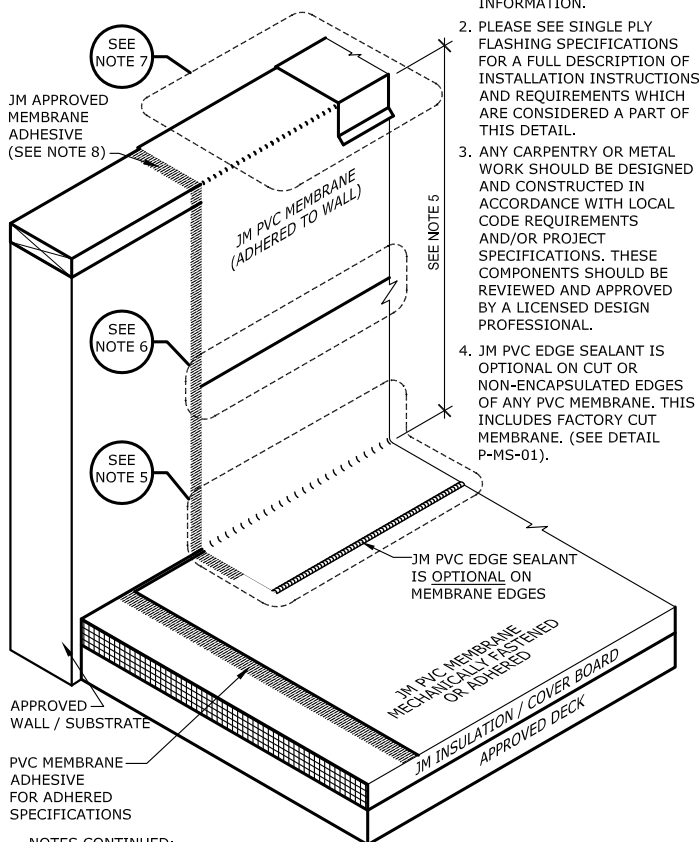

NOTES:

1. REFER TO JOHNS MANVILLE WEBSITE (www.jm.com) FOR MOST UP-TO-DATE INFORMATION.
2. PLEASE SEE SINGLE PLY FLASHING SPECIFICATIONS FOR A FULL DESCRIPTION OF INSTALLATION INSTRUCTIONS AND REQUIREMENTS WHICH ARE CONSIDERED A PART OF THIS DETAIL.
3. ANY CARPENTRY OR METAL WORK SHOULD BE DESIGNED AND CONSTRUCTED IN ACCORDANCE WITH LOCAL CODE REQUIREMENTS AND/OR PROJECT SPECIFICATIONS. THESE COMPONENTS SHOULD BE REVIEWED AND APPROVED BY A LICENSED DESIGN PROFESSIONAL.
4. JM PVC EDGE SEALANT IS OPTIONAL ON CUT OR NON-ENCAPSULATED EDGES OF ANY PVC MEMBRANE. THIS INCLUDES FACTORY CUT MEMBRANE. (SEE DETAIL P-MS-01).

NOTES CONTINUED:

5. FOR JM APPROVED BASE FLASHING FASTENING METHODS SEE P-FW-B DETAILS. A SUFFICIENT BACKER FASTENING STRIP MUST BE INSTALLED BEHIND SUBSTRATES DIRECTLY TO STUDS FOR INSTALLATION OF TERMINATION BARS AND FLASHINGS WHEN SUBSTRATES WILL NOT SUPPORT A PROPER, SECURE INSTALLATION. SEE DETAIL P-FW-M2I FOR BACKER DETAIL.
6. FOR JM APPROVED INTERMEDIATE FLASHING FASTENING METHODS SEE P-FW-I DETAILS. MINIMUM FLASHING TERMINATION HEIGHT IS 8" (203 mm) ABOVE ROOF SURFACE. INTERMEDIATE ADHERED MEMBRANE FASTENING REQUIRED AT 5'-0" (1.52 m) INTERVALS MAXIMUM, AND 18" (457 mm) HIGH MAXIMUM FOR NON ADHERED MEMBRANE ON CMU, BRICK, SMOOTH CONCRETE WALLS, OR ANY JM APPROVED SUBSTRATE, IE. PLYWOOD, SECUROCK® GYPSUM-FIBER AND DENSDECK®. SEE DETAIL P-FW-M2I FOR JM APPROVED FASTENING METHODS.
7. FOR JM APPROVED TOP OF WALL FLASHING METHODS SEE P-FW-T DETAILS.
8. JM APPROVED ADHESIVES FOR USE ON VERTICAL FLASHING APPLICATIONS INCLUDES JM PVC MEMBRANE ADHESIVES (LOW VOC ONLY).

Johns Manville is a manufacturer of commercial roofing products and offers this general conceptual information to you as a courtesy. This complimentary assistance is not to be used or relied upon by anyone as a substitute for professional engineering design and documentation required by building code, contract, or applicable law. By accepting these comments you agree they do not constitute any representations, endorsements of, or an assumption by Johns Manville of any liability for either the adequacy of design of this building or any other material not supplied by Johns Manville.

Note: For the most current information on general guidelines, please refer to the System Considerations tab under Commercial Roofing Products on the JM Roofing Web site. For specifications, flashing details and general installation information please refer to the Application Tools tab.

Refer to the Safe Use Instructions and product label prior to using this product.



Highwall Flashing with Metal Backing Strip Isometric View Master Detail

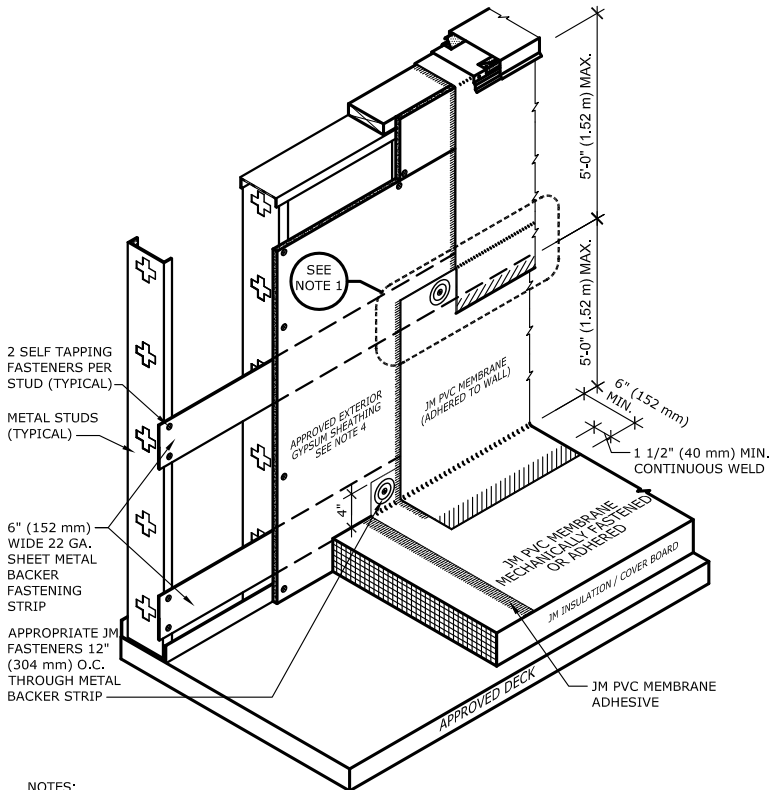

NOTES:

1. FOR JM APPROVED INTERMEDIATE FLASHING FASTENING METHODS SEE P-FW-I DETAILS. MINIMUM FLASHING TERMINATION HEIGHT IS 8" (203 mm) ABOVE ROOF SURFACE. INTERMEDIATE ADHERED MEMBRANE FASTENING REQUIRED AT 5'-0" (1.52 m) INTERVALS MAXIMUM, AND 18" (457 mm) HIGH MAXIMUM FOR NON ADHERED MEMBRANE ON CMU, BRICK, SMOOTH CONCRETE WALLS, OR ANY JM APPROVED SUBSTRATE, I.E. PLYWOOD, SECUROCK® GYPSUM-FIBER AND DENSCDECK® SEE DETAIL P-FW-M2I FOR JM APPROVED FASTENING METHODS.
2. FOR JM APPROVED BASE FLASHING FASTENING METHODS SEE P-FW-B DETAILS. A SUFFICIENT BACKER FASTENING STRIP MUST BE INSTALLED BEHIND SUBSTRATES DIRECTLY TO STUDS FOR INSTALLATION OF TERMINATION BARS AND FLASHINGS WHEN SUBSTRATES WILL NOT SUPPORT A PROPER, SECURE INSTALLATION. SEE DETAIL P-FW-M2I FOR BACKER DETAIL.
3. FOR JM APPROVED TOP OF WALL FLASHING METHODS SEE P-FW-T DETAILS.
4. APPROVED EXTERIOR GYPSUM SHEATHING FOR ROOF FLASHING APPLICATION INCLUDE SECUROCK® GYPSUM-FIBER AND DENSCDECK®.

Johns Manville is a manufacturer of commercial roofing products and offers this general conceptual information to you as a courtesy. This complimentary assistance is not to be used or relied upon by anyone as a substitute for professional engineering design and documentation required by building code, contract, or applicable law. By accepting these comments you agree they do not constitute any representations, endorsements of, or an assumption by Johns Manville of any liability for either the adequacy of design of this building or any other material not supplied by Johns Manville.

Note: For the most current information on general guidelines, please refer to the System Considerations tab under Commercial Roofing Products on the JM Roofing Web site. For specifications, flashing details and general installation information please refer to the Application Tools tab.

Refer to the Safe Use Instructions and product label prior to using this product.



Base Tie-In-Fastener & Plate

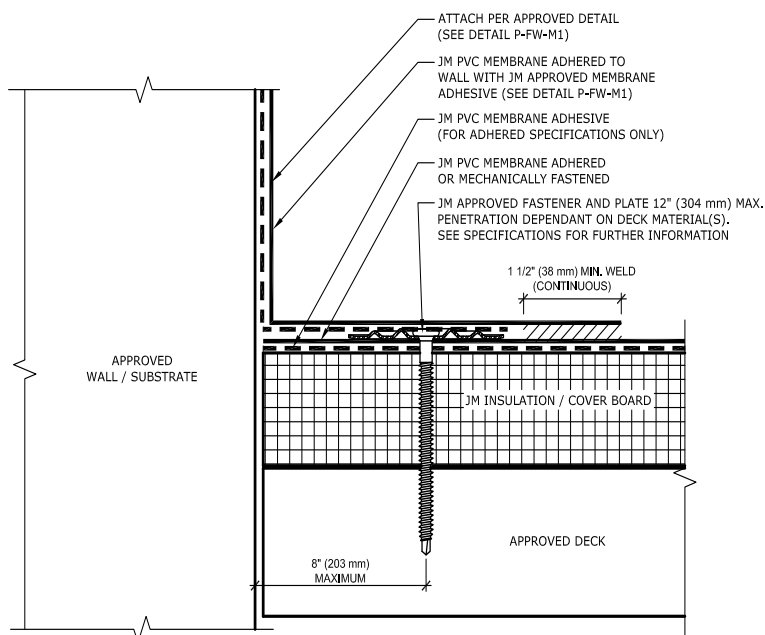

NOTES:

1. REFER TO JOHNS MANVILLE WEBSITE (www.jm.com) FOR MOST UP-TO-DATE INFORMATION.
2. PLEASE SEE SINGLE PLY FLASHING SPECIFICATIONS FOR A FULL DESCRIPTION OF INSTALLATION INSTRUCTIONS AND REQUIREMENTS WHICH ARE CONSIDERED A PART OF THIS DETAIL.
3. ANY CARPENTRY OR METAL WORK SHOULD BE DESIGNED AND CONSTRUCTED IN ACCORDANCE WITH LOCAL CODE REQUIREMENTS AND/OR PROJECT SPECIFICATIONS. THESE COMPONENTS SHOULD BE REVIEWED AND APPROVED BY A LICENSED DESIGN PROFESSIONAL.
4. THIS DETAIL IS ALSO SUITABLE FOR TERMINATION OF FLEECE BACKED MEMBRANES. NON FLEECE BACK MEMBRANE IS REQUIRED FOR WALL FLASHINGS.

Maximum Guarantee Term: 30 Year

Johns Manville is a manufacturer of commercial roofing products and offers this general conceptual information to you as a courtesy. This complimentary assistance is not to be used or relied upon by anyone as a substitute for professional engineering design and documentation required by building code, contract, or applicable law. By accepting these comments you agree they do not constitute any representations, endorsements of, or an assumption by Johns Manville of any liability for either the adequacy of design of this building or any other material not supplied by Johns Manville.

Note: For the most current information on general guidelines, please refer to the System Considerations tab under Commercial Roofing Products on the JM Roofing Web site. For specifications, flashing details and general installation information please refer to the Application Tools tab.

Refer to the Safe Use Instructions and product label prior to using this product.



Base Tie-In-Fastener & Plate - on Wall

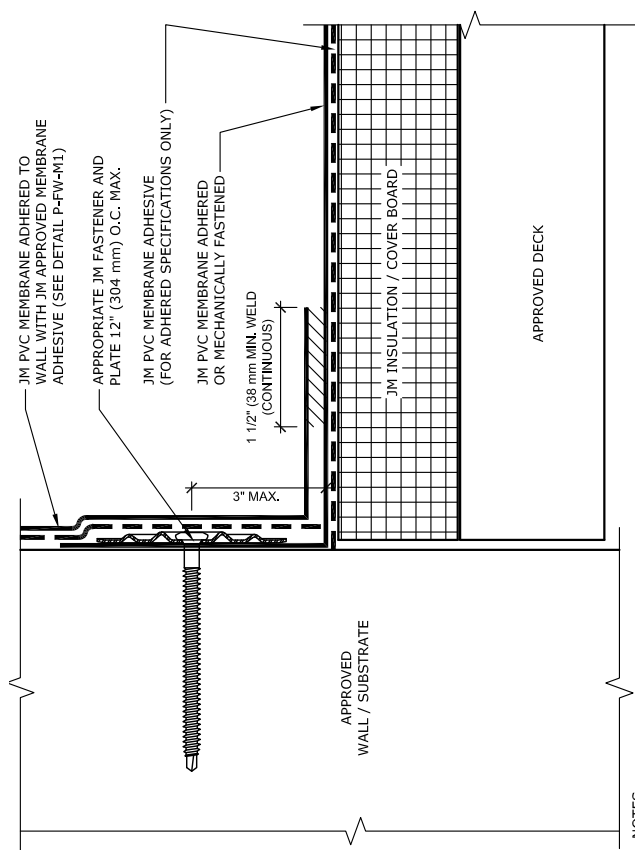

NOTES:

1. REFER TO JOHNS MANVILLE WEBSITE (www.jm.com) FOR MOST UP-TO-DATE INFORMATION.
2. PLEASE SEE SINGLE PLY FLASHING SPECIFICATIONS FOR A FULL DESCRIPTION OF INSTALLATION INSTRUCTIONS AND REQUIREMENTS WHICH ARE CONSIDERED A PART OF THIS DETAIL.
3. ANY CARPENTRY OR METAL WORK SHOULD BE DESIGNED AND CONSTRUCTED IN ACCORDANCE WITH LOCAL CODE REQUIREMENTS AND/OR PROJECT SPECIFICATIONS. THESE COMPONENTS SHOULD BE REVIEWED AND APPROVED BY A LICENSED DESIGN PROFESSIONAL.

Maximum Guarantee Term: 30 Year

Johns Manville is a manufacturer of commercial roofing products and offers this general conceptual information to you as a courtesy. This complimentary assistance is not to be used or relied upon by anyone as a substitute for professional engineering design and documentation required by building code, contract, or applicable law. By accepting these comments you agree they do not constitute any representations, endorsements of, or an assumption by Johns Manville of any liability for either the adequacy of design of this building or any other material not supplied by Johns Manville.

Note: For the most current information on general guidelines, please refer to the System Considerations tab under Commercial Roofing Products on the JM Roofing Web site. For specifications, flashing details and general installation information please refer to the Application Tools tab.

Refer to the Safe Use Instructions and product label prior to using this product.



Membrane Flashing Base Tie-In - High Internal Pressure

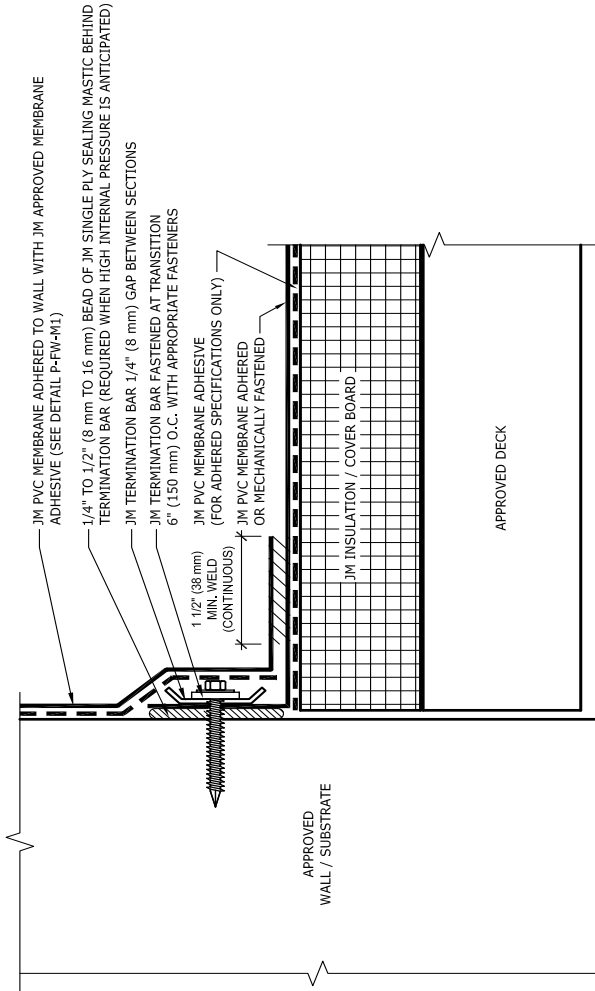

NOTES:

1. REFER TO JOHNS MANVILLE WEBSITE (www.jm.com) FOR MOST UP-TO-DATE INFORMATION.
2. PLEASE SEE SINGLE PLY FLASHING SPECIFICATIONS FOR A FULL DESCRIPTION OF INSTALLATION INSTRUCTIONS AND REQUIREMENTS WHICH ARE CONSIDERED A PART OF THIS DETAIL.
3. ANY CARPENTRY OR METAL WORK SHOULD BE DESIGNED AND CONSTRUCTED IN ACCORDANCE WITH LOCAL CODE REQUIREMENTS AND/OR PROJECT SPECIFICATIONS. THESE COMPONENTS SHOULD BE REVIEWED AND APPROVED BY A LICENSED DESIGN PROFESSIONAL.
4. THIS DETAIL IS ALSO SUITABLE FOR TERMINATION OF FLEECE BACKED MEMBRANES. NON FLEECE BACKED MEMBRANE IS REQUIRED FOR WALL FLASHINGS.

Maximum Guarantee Term: 30 Year

Johns Manville is a manufacturer of commercial roofing products and offers this general conceptual information to you as a courtesy. This complimentary assistance is not to be used or relied upon by anyone as a substitute for professional engineering design and documentation required by building code, contract, or applicable law. By accepting these comments you agree they do not constitute any representations, endorsements of, or an assumption by Johns Manville of any liability for either the adequacy of design of this building or any other material not supplied by Johns Manville.

Note: For the most current information on general guidelines, please refer to the System Considerations tab under Commercial Roofing Products on the JM Roofing Web site. For specifications, flashing details and general installation information please refer to the Application Tools tab.

Refer to the Safe Use Instructions and product label prior to using this product.



Base Tie-In - RhinoPlate System

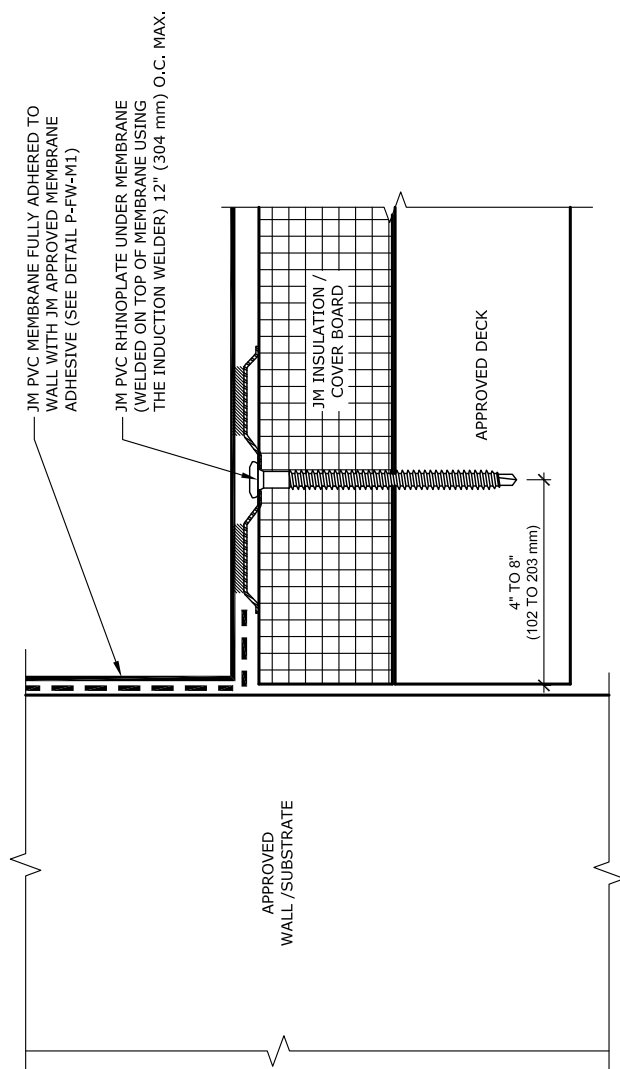

NOTES:

1. REFER TO JOHNS MANVILLE WEBSITE (www.jm.com) FOR MOST UP-TO-DATE INFORMATION.
2. PLEASE SEE SINGLE PLY FLASHING SPECIFICATIONS FOR A FULL DESCRIPTION OF INSTALLATION INSTRUCTIONS AND REQUIREMENTS WHICH ARE CONSIDERED A PART OF THIS DETAIL.
3. ANY CARPENTRY OR METAL WORK SHOULD BE DESIGNED AND CONSTRUCTED IN ACCORDANCE WITH LOCAL CODE REQUIREMENTS AND/OR PROJECT SPECIFICATIONS. THESE COMPONENTS SHOULD BE REVIEWED AND APPROVED BY A LICENSED DESIGN PROFESSIONAL.

Maximum Guarantee Term: 20 Year

Johns Manville is a manufacturer of commercial roofing products and offers this general conceptual information to you as a courtesy. This complimentary assistance is not to be used or relied upon by anyone as a substitute for professional engineering design and documentation required by building code, contract, or applicable law. By accepting these comments you agree they do not constitute any representations, endorsements of, or an assumption by Johns Manville of any liability for either the adequacy of design of this building or any other material not supplied by Johns Manville.

Note: For the most current information on general guidelines, please refer to the System Considerations tab under Commercial Roofing Products on the JM Roofing Web site. For specifications, flashing details and general installation information please refer to the Application Tools tab.

Refer to the Safe Use Instructions and product label prior to using this product.



Base Tie-In (Loose Hung Flashing)

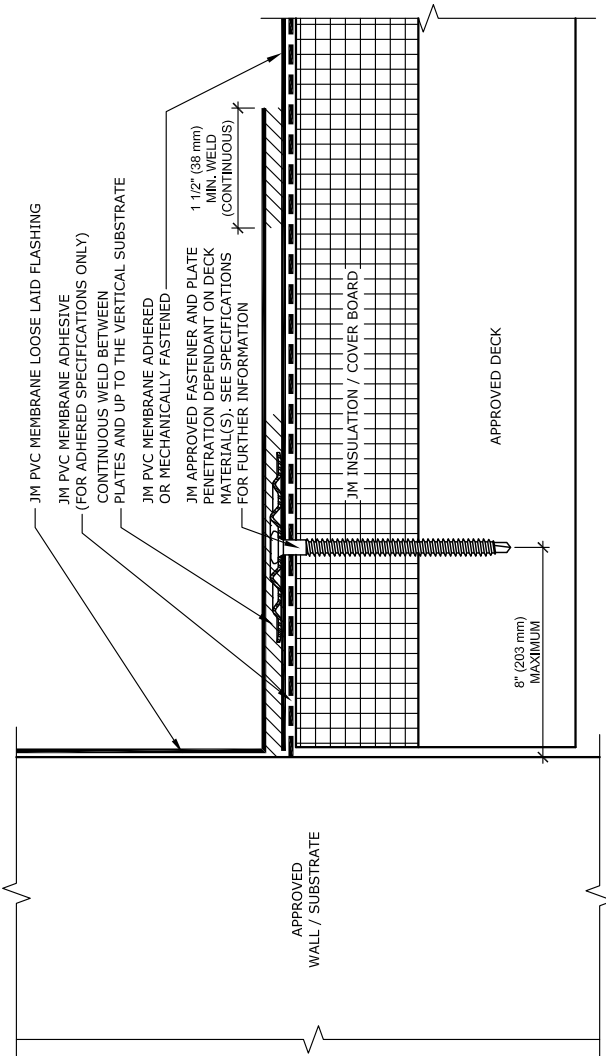

NOTES:

1. REFER TO JOHNS MANVILLE WEBSITE (www.jm.com) FOR MOST UP-TO-DATE INFORMATION.
2. PLEASE SEE SINGLE PLY FLASHING SPECIFICATIONS FOR A FULL DESCRIPTION OF INSTALLATION INSTRUCTIONS AND REQUIREMENTS WHICH ARE CONSIDERED A PART OF THIS DETAIL.
3. ANY CARPENTRY OR METAL WORK SHOULD BE DESIGNED AND CONSTRUCTED IN ACCORDANCE WITH LOCAL CODE REQUIREMENTS AND/OR PROJECT SPECIFICATIONS. THESE COMPONENTS SHOULD BE REVIEWED AND APPROVED BY A LICENSED DESIGN PROFESSIONAL.
4. JM PVC EDGE SEALANT IS OPTIONAL ON PVC MEMBRANE EDGES.
5. THIS DETAIL IS ALSO SUITABLE FOR TERMINATION OF FLEECE BACKED MEMBRANES. NON FLEECE BACK MEMBRANE IS REQUIRED FOR WALL FLASHINGS.

Maximum Guarantee Term: 20 Year

Johns Manville is a manufacturer of commercial roofing products and offers this general conceptual information to you as a courtesy. This complimentary assistance is not to be used or relied upon by anyone as a substitute for professional engineering design and documentation required by building code, contract, or applicable law. By accepting these comments you agree they do not constitute any representations, endorsements of, or an assumption by Johns Manville of any liability for either the adequacy of design of this building or any other material not supplied by Johns Manville.

Note: For the most current information on general guidelines, please refer to the System Considerations tab under Commercial Roofing Products on the JM Roofing Web site. For specifications, flashing details and general installation information please refer to the Application Tools tab.

Refer to the Safe Use Instructions and product label prior to using this product.



Base Tie-In Fleece Backed PVC in RSUA

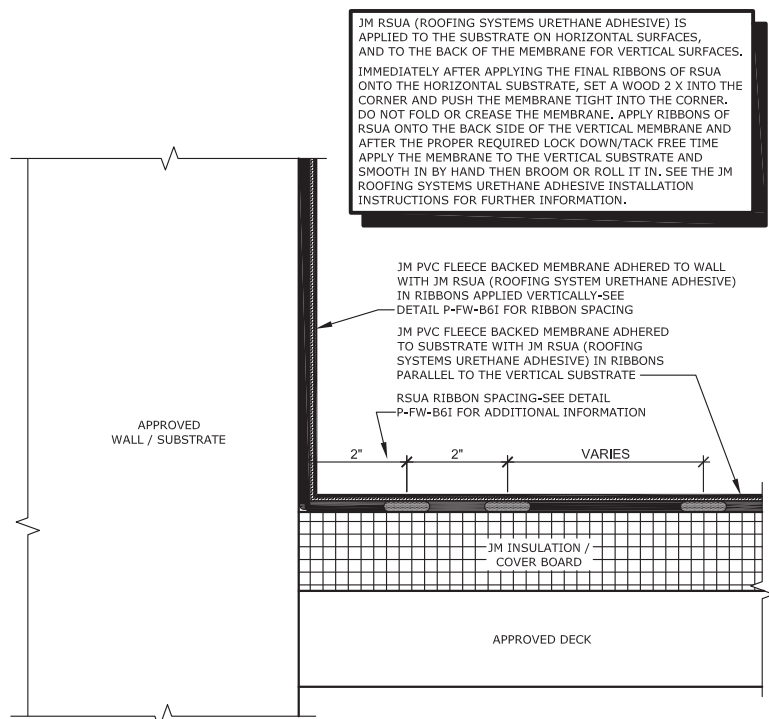

NOTES:

1. REFER TO JOHNS MANVILLE WEBSITE (www.jm.com) FOR MOST UP-TO-DATE INFORMATION.
2. PLEASE SEE SINGLE PLY FLASHING SPECIFICATIONS FOR A FULL DESCRIPTION OF INSTALLATION INSTRUCTIONS AND REQUIREMENTS WHICH ARE CONSIDERED A PART OF THIS DETAIL.
3. ANY CARPENTRY OR METAL WORK SHOULD BE DESIGNED AND CONSTRUCTED IN ACCORDANCE WITH LOCAL CODE REQUIREMENTS AND/OR PROJECT SPECIFICATIONS. THESE COMPONENTS SHOULD BE REVIEWED AND APPROVED BY A LICENSED DESIGN PROFESSIONAL.
4. FOR JM APPROVED INTERMEDIATE FLASHING FASTENING METHODS SEE P-FW-I DETAILS. INTERMEDIATE ADHERED MEMBRANE FASTENING REQUIRED AT 5'-0" (1.52 m) INTERVALS MAXIMUM, SEE DETAIL P-FW-M2I FOR JM APPROVED FASTENING METHODS.
5. PLEASE SEE DETAIL P-FW-B6I FOR ADDITIONAL INSTALLATION INFORMATION.

Johns Manville is a manufacturer of commercial roofing products and offers this general conceptual information to you as a courtesy. This complimentary assistance is not to be used or relied upon by anyone as a substitute for professional engineering design and documentation required by building code, contract, or applicable law. By accepting these comments you agree they do not constitute any representations, endorsements of, or an assumption by Johns Manville of any liability for either the adequacy of design of this building or any other material not supplied by Johns Manville.

Note: For the most current information on general guidelines, please refer to the System Considerations tab under Commercial Roofing Products on the JM Roofing Web site. For specifications, flashing details and general installation information please refer to the Application Tools tab.

Refer to the Safe Use Instructions and product label prior to using this product.



PVC Fleece Backed in RSUA Base & Wall Flashing

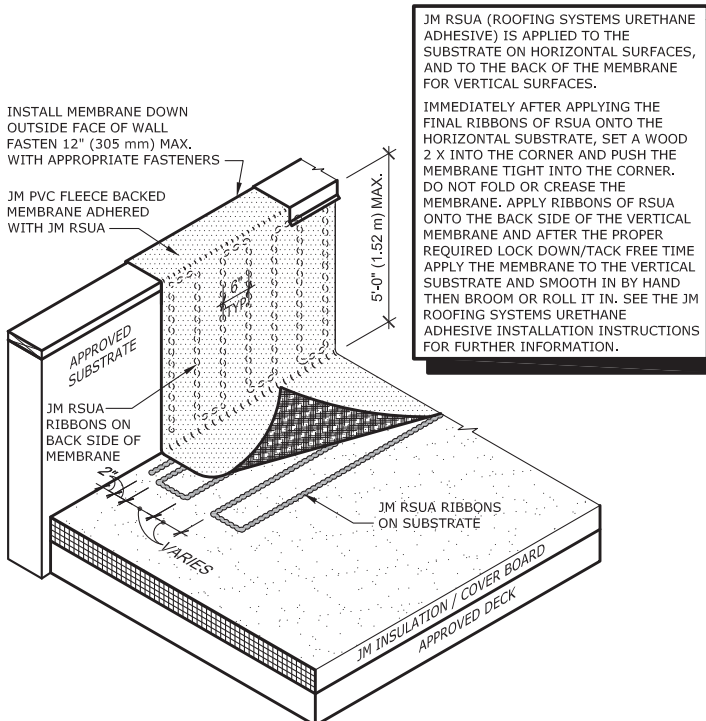

JM RSUA (ROOFING SYSTEMS URETHANE ADHESIVE) IS APPLIED TO THE SUBSTRATE ON HORIZONTAL SURFACES, AND TO THE BACK OF THE MEMBRANE FOR VERTICAL SURFACES.

IMMEDIATELY AFTER APPLYING THE FINAL RIBBONS OF RSUA ONTO THE HORIZONTAL SUBSTRATE, SET A WOOD 2 X INTO THE CORNER AND PUSH THE MEMBRANE TIGHT INTO THE CORNER. DO NOT FOLD OR CREATE THE MEMBRANE. APPLY RIBBONS OF RSUA ONTO THE BACK SIDE OF THE VERTICAL MEMBRANE AND AFTER THE PROPER REQUIRED LOCK DOWN/TACK FREE TIME APPLY THE MEMBRANE TO THE VERTICAL SUBSTRATE AND SMOOTH IN BY HAND THEN BROOM OR ROLL IT IN. SEE THE JM ROOFING SYSTEMS URETHANE ADHESIVE INSTALLATION INSTRUCTIONS FOR FURTHER INFORMATION.

NOTES:

1. REFER TO JOHNS MANVILLE WEBSITE (www.Jm.com) FOR MOST UP-TO-DATE INFORMATION.
2. PLEASE SEE SINGLE PLY FLASHING SPECIFICATIONS FOR A FULL DESCRIPTION OF INSTALLATION INSTRUCTIONS AND REQUIREMENTS WHICH ARE CONSIDERED A PART OF THIS DETAIL.
3. ANY CARPENTRY OR METAL WORK SHOULD BE DESIGNED AND CONSTRUCTED IN ACCORDANCE WITH LOCAL CODE REQUIREMENTS AND/OR PROJECT SPECIFICATIONS. THESE COMPONENTS SHOULD BE REVIEWED AND APPROVED BY A LICENSED DESIGN PROFESSIONAL.
4. JM PVC EDGE SEALANT IS OPTIONAL ON ALL CUT OR NON-ENCAPSULATED EDGES OF REINFORCED MEMBRANE. THIS INCLUDES FACTORY CUT MEMBRANE (SEE DETAIL P-MS-01).
5. A SUFFICIENT BACKER FASTENING STRIP MUST BE INSTALLED BEHIND SUBSTRATES DIRECTLY TO STUDS FOR INSTALLATION OF TERMINATION BARS AND FLASHINGS WHEN SUBSTRATES WILL NOT SUPPORT A PROPER, SECURE INSTALLATION. SEE DETAIL P-FW-M21 FOR BACKER DETAIL.
6. FOR JM APPROVED INTERMEDIATE FLASHING FASTENING METHODS SEE P-FW-1 DETAILS. MINIMUM FLASHING TERMINATION HEIGHT IS 8" (203 mm) ABOVE ROOF SURFACE. INTERMEDIATE ADHERED MEMBRANE FASTENING REQUIRED AT 5'-0" (1.52 m) INTERVALS MAXIMUM, AND 18" (457 mm) HIGH MAXIMUM FOR NON ADHERED MEMBRANE ON CMU, BRICK, SMOOTH CONCRETE WALLS, OR ANY JM APPROVED SUBSTRATE, IE. PLYWOOD, SECUROCK® GYPSUM-FIBER AND DENSDECK®. SEE DETAIL P-FW-M21 FOR JM APPROVED FASTENING METHODS.
7. FOR JM APPROVED TOP OF WALL FLASHING METHODS SEE P-FW-T DETAILS.

Johns Manville is a manufacturer of commercial roofing products and offers this general conceptual information to you as a courtesy. This complimentary assistance is not to be used or relied upon by anyone as a substitute for professional engineering design and documentation required by building code, contract, or applicable law. By accepting these comments you agree they do not constitute any representations, endorsements of, or an assumption by Johns Manville of any liability for either the adequacy of design of this building or any other material not supplied by Johns Manville.

Note: For the most current information on general guidelines, please refer to the System Considerations tab under Commercial Roofing Products on the JM Roofing Web site. For specifications, flashing details and general installation information please refer to the Application Tools tab.

Refer to the Safe Use Instructions and product label prior to using this product.



PVC Intermediate Membrane Attachment with Fastener & Plate

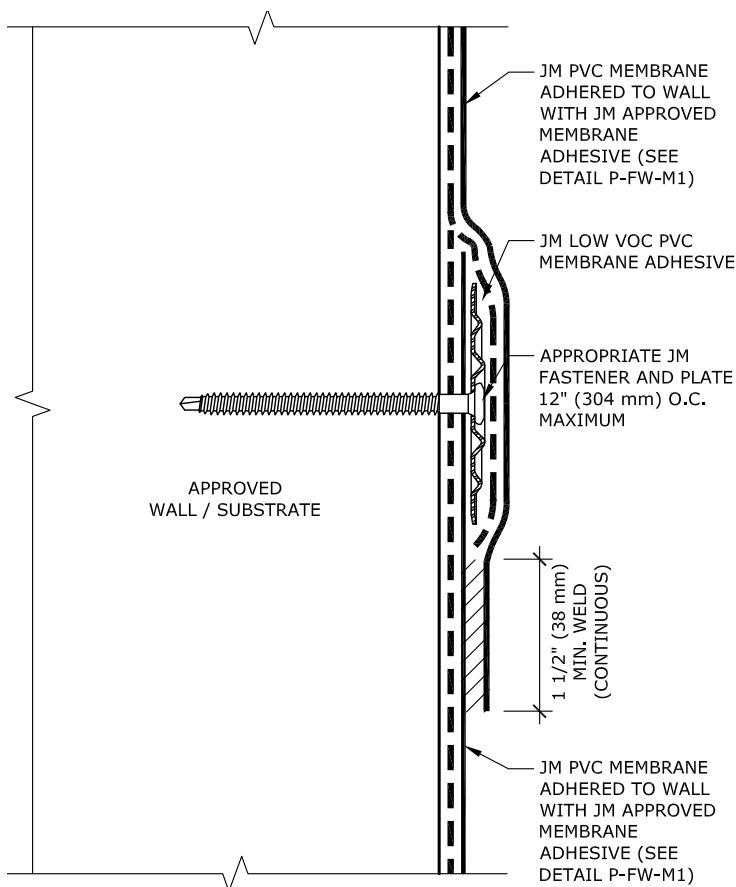

NOTES:

1. REFER TO JOHNS MANVILLE WEBSITE (www.jm.com) FOR MOST UP-TO-DATE INFORMATION.
2. PLEASE SEE SINGLE PLY FLASHING SPECIFICATIONS FOR A FULL DESCRIPTION OF INSTALLATION INSTRUCTIONS AND REQUIREMENTS WHICH ARE CONSIDERED A PART OF THIS DETAIL.
3. ANY CARPENTRY OR METAL WORK SHOULD BE DESIGNED AND CONSTRUCTED IN ACCORDANCE WITH LOCAL CODE REQUIREMENTS AND/OR PROJECT SPECIFICATIONS. THESE COMPONENTS SHOULD BE REVIEWED AND APPROVED BY A LICENSED DESIGN PROFESSIONAL.
4. A SUFFICIENT BACKER FASTENING STRIP MUST BE INSTALLED BEHIND SUBSTRATES DIRECTLY TO STUDS FOR INSTALLATION OF TERMINATION BARS, BATTEN STRIPS, AND FLASHINGS WHEN SUBSTRATES WILL NOT SUPPORT A PROPER, SECURE INSTALLATION.

Maximum Guarantee Term: 30 Year

Johns Manville is a manufacturer of commercial roofing products and offers this general conceptual information to you as a courtesy. This complimentary assistance is not to be used or relied upon by anyone as a substitute for professional engineering design and documentation required by building code, contract, or applicable law. By accepting these comments you agree they do not constitute any representations, endorsements of, or an assumption by Johns Manville of any liability for either the adequacy of design of this building or any other material not supplied by Johns Manville.

Note: For the most current information on general guidelines, please refer to the System Considerations tab under Commercial Roofing Products on the JM Roofing Web site. For specifications, flashing details and general installation information please refer to the Application Tools tab.

Refer to the Safe Use Instructions and product label prior to using this product.



PVC Detail Strip Wall Flashing Attachment with Fastener & Plate

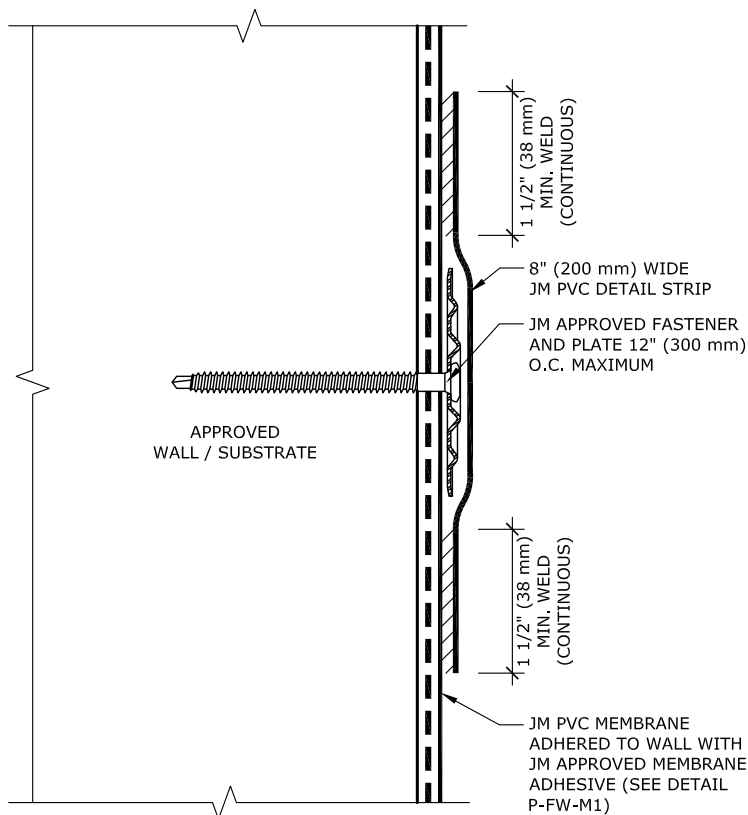

NOTES:

1. REFER TO JOHNS MANVILLE WEBSITE (www.jm.com) FOR MOST UP-TO-DATE INFORMATION.
2. PLEASE SEE SINGLE PLY FLASHING SPECIFICATIONS FOR A FULL DESCRIPTION OF INSTALLATION INSTRUCTIONS AND REQUIREMENTS WHICH ARE CONSIDERED A PART OF THIS DETAIL.
3. ANY CARPENTRY OR METAL WORK SHOULD BE DESIGNED AND CONSTRUCTED IN ACCORDANCE WITH LOCAL CODE REQUIREMENTS AND/OR PROJECT SPECIFICATIONS. THESE COMPONENTS SHOULD BE REVIEWED AND APPROVED BY A LICENSED DESIGN PROFESSIONAL.
4. A SUFFICIENT BACKER FASTENING STRIP MUST BE INSTALLED BEHIND SUBSTRATES DIRECTLY TO STUDS FOR INSTALLATION OF TERMINATION BARS AND FLASHING WHEN SUBSTRATES WILL NOT SUPPORT A PROPER, SECURE INSTALLATION.

Maximum Guarantee Term: 30 Year

Johns Manville is a manufacturer of commercial roofing products and offers this general conceptual information to you as a courtesy. This complimentary assistance is not to be used or relied upon by anyone as a substitute for professional engineering design and documentation required by building code, contract, or applicable law. By accepting these comments you agree they do not constitute any representations, endorsements of, or an assumption by Johns Manville of any liability for either the adequacy of design of this building or any other material not supplied by Johns Manville.

Note: For the most current information on general guidelines, please refer to the System Considerations tab under Commercial Roofing Products on the JM Roofing Web site. For specifications, flashing details and general installation information please refer to the Application Tools tab.

Refer to the Safe Use Instructions and product label prior to using this product.



PVC Intermediate Membrane Attachment with Term Bar

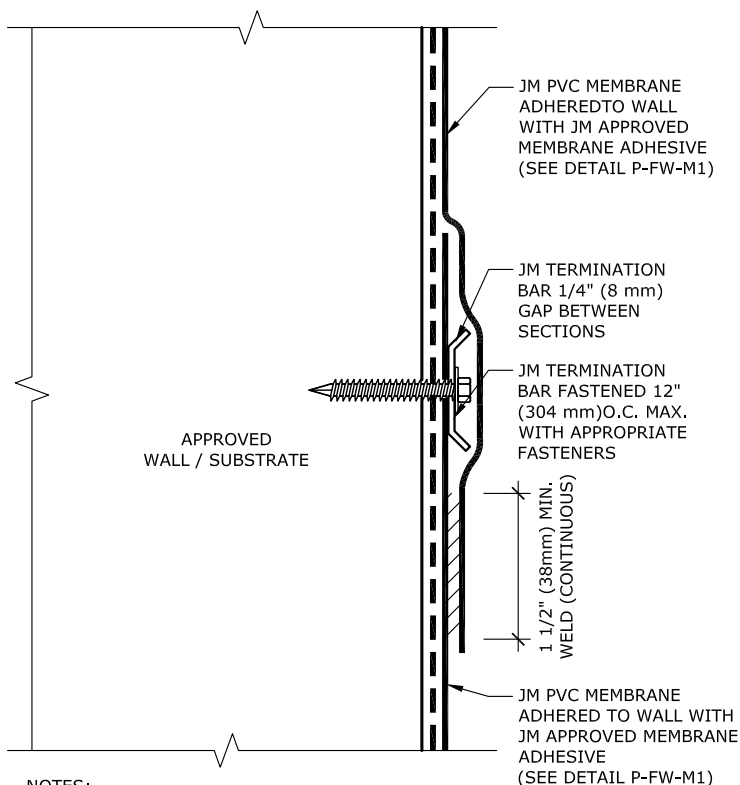

NOTES:

1. REFER TO JOHNS MANVILLE WEBSITE (www.jm.com) FOR MOST UP-TO-DATE INFORMATION.
2. PLEASE SEE SINGLE PLY FLASHING SPECIFICATIONS FOR A FULL DESCRIPTION OF INSTALLATION INSTRUCTIONS AND REQUIREMENTS WHICH ARE CONSIDERED A PART OF THIS DETAIL.
3. ANY CARPENTRY OR METAL WORK SHOULD BE DESIGNED AND CONSTRUCTED IN ACCORDANCE WITH LOCAL CODE REQUIREMENTS AND/OR PROJECT SPECIFICATIONS. THESE COMPONENTS SHOULD BE REVIEWED AND APPROVED BY A LICENSED DESIGN PROFESSIONAL.
4. A SUFFICIENT BACKER FASTENING STRIP MUST BE INSTALLED BEHIND SUBSTRATES DIRECTLY TO STUDS FOR INSTALLATION OF TERMINATION BARS AND FLASHING WHEN SUBSTRATES WILL NOT SUPPORT A PROPER, SECURE INSTALLATION.

Maximum Guarantee Term: 30 Year

Johns Manville is a manufacturer of commercial roofing products and offers this general conceptual information to you as a courtesy. This complimentary assistance is not to be used or relied upon by anyone as a substitute for professional engineering design and documentation required by building code, contract, or applicable law. By accepting these comments you agree they do not constitute any representations, endorsements of, or an assumption by Johns Manville of any liability for either the adequacy of design of this building or any other material not supplied by Johns Manville.

Note: For the most current information on general guidelines, please refer to the System Considerations tab under Commercial Roofing Products on the JM Roofing Web site. For specifications, flashing details and general installation information please refer to the Application Tools tab.

Refer to the Safe Use Instructions and product label prior to using this product.



Term Bar Flashing Attachment with Welded PVC Detail Strip

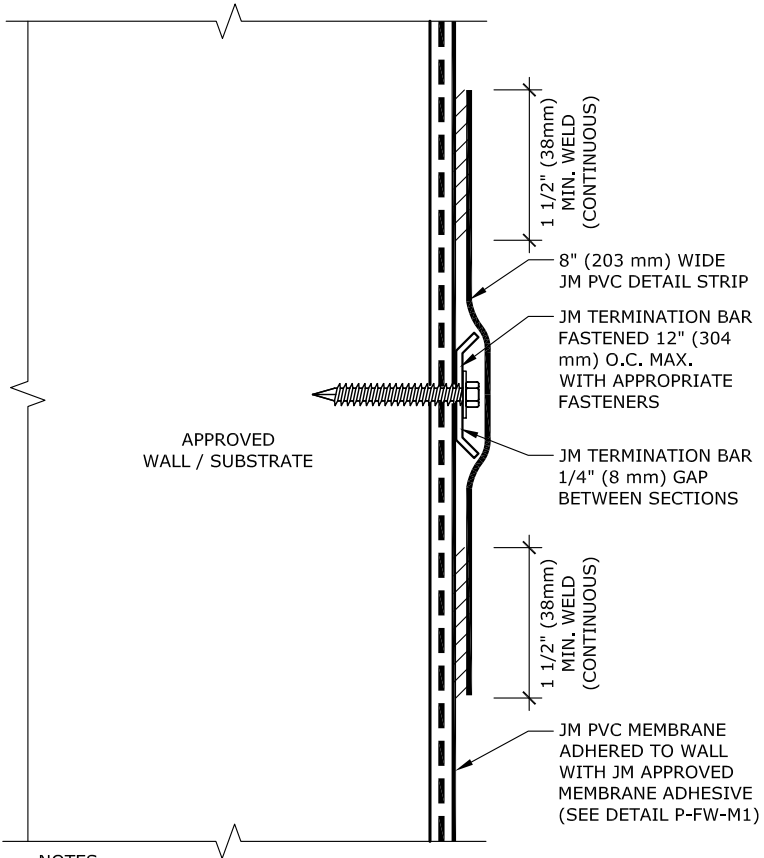

NOTES:

1. REFER TO JOHNS MANVILLE WEBSITE (www.jm.com) FOR MOST UP-TO-DATE INFORMATION.
2. PLEASE SEE SINGLE PLY FLASHING SPECIFICATIONS FOR A FULL DESCRIPTION OF INSTALLATION INSTRUCTIONS AND REQUIREMENTS WHICH ARE CONSIDERED A PART OF THIS DETAIL.
3. ANY CARPENTRY OR METAL WORK SHOULD BE DESIGNED AND CONSTRUCTED IN ACCORDANCE WITH LOCAL CODE REQUIREMENTS AND/OR PROJECT SPECIFICATIONS. THESE COMPONENTS SHOULD BE REVIEWED AND APPROVED BY A LICENSED DESIGN PROFESSIONAL.
4. A SUFFICIENT BACKER FASTENING STRIP MUST BE INSTALLED BEHIND SUBSTRATES DIRECTLY TO STUDS FOR INSTALLATION OF TERMINATION BARS, BATTEN STRIPS, AND FLASHINGS WHEN SUBSTRATES WILL NOT SUPPORT A PROPER, SECURE INSTALLATION.

Maximum Guarantee Term: 30 Year

Johns Manville is a manufacturer of commercial roofing products and offers this general conceptual information to you as a courtesy. This complimentary assistance is not to be used or relied upon by anyone as a substitute for professional engineering design and documentation required by building code, contract, or applicable law. By accepting these comments you agree they do not constitute any representations, endorsements of, or an assumption by Johns Manville of any liability for either the adequacy of design of this building or any other material not supplied by Johns Manville.

Note: For the most current information on general guidelines, please refer to the System Considerations tab under Commercial Roofing Products on the JM Roofing Web site. For specifications, flashing details and general installation information please refer to the Application Tools tab.

Refer to the Safe Use Instructions and product label prior to using this product.



Continuous Flashing Attachment - Termination Bar

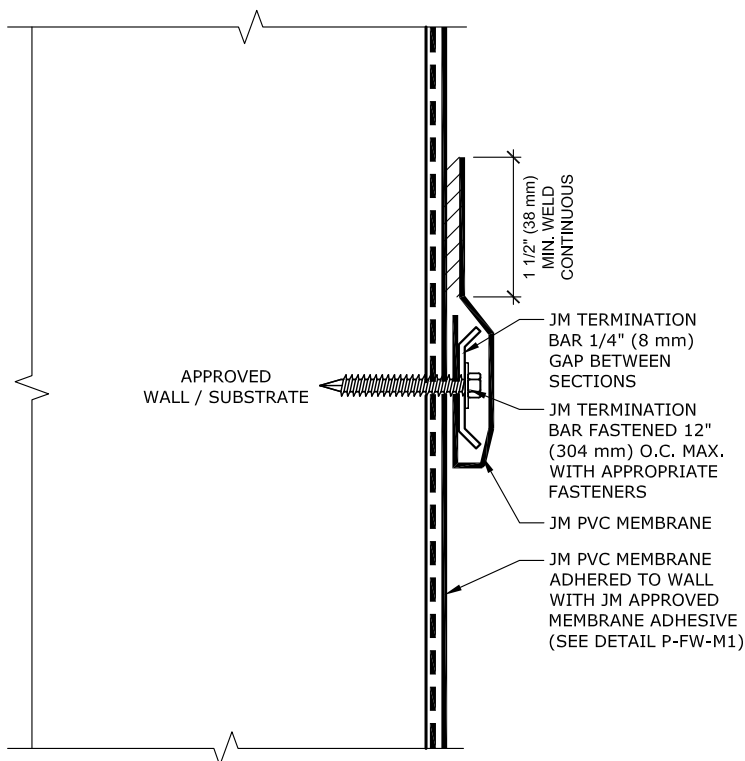

NOTES:

1. REFER TO JOHNS MANVILLE WEBSITE (www.jm.com) FOR MOST UP-TO-DATE INFORMATION.
2. PLEASE SEE SINGLE PLY FLASHING SPECIFICATIONS FOR A FULL DESCRIPTION OF INSTALLATION INSTRUCTIONS AND REQUIREMENTS WHICH ARE CONSIDERED A PART OF THIS DETAIL.
3. ANY CARPENTRY OR METAL WORK SHOULD BE DESIGNED AND CONSTRUCTED IN ACCORDANCE WITH LOCAL CODE REQUIREMENTS AND/OR PROJEC SPECIFICATIONS. THESE COMPONENTS SHOULD BE REVIEWED AND APPROVED BY A LICENSED DESIGN PROFESSIONAL.
4. A SUFFICIENT BACKER FASTENING STRIP MUST BE INSTALLED BEHIND SUBSTRATES DIRECTLY TO STUDS FOR INSTALLATION OF TERMINATION BARS AND FLASHING WHEN SUBSTRATES WILL NOT SUPPORT A PROPER, SECURE INSTALLATION.

Maximum Guarantee Term: 20 Year

Johns Manville is a manufacturer of commercial roofing products and offers this general conceptual information to you as a courtesy. This complimentary assistance is not to be used or relied upon by anyone as a substitute for professional engineering design and documentation required by building code, contract, or applicable law. By accepting these comments you agree they do not constitute any representations, endorsements of, or an assumption by Johns Manville of any liability for either the adequacy of design of this building or any other material not supplied by Johns Manville.

Note: For the most current information on general guidelines, please refer to the System Considerations tab under Commercial Roofing Products on the JM Roofing Web site. For specifications, flashing details and general installation information please refer to the Application Tools tab.

Refer to the Safe Use Instructions and product label prior to using this product.



Split Flashing Attachment - Termination Bar

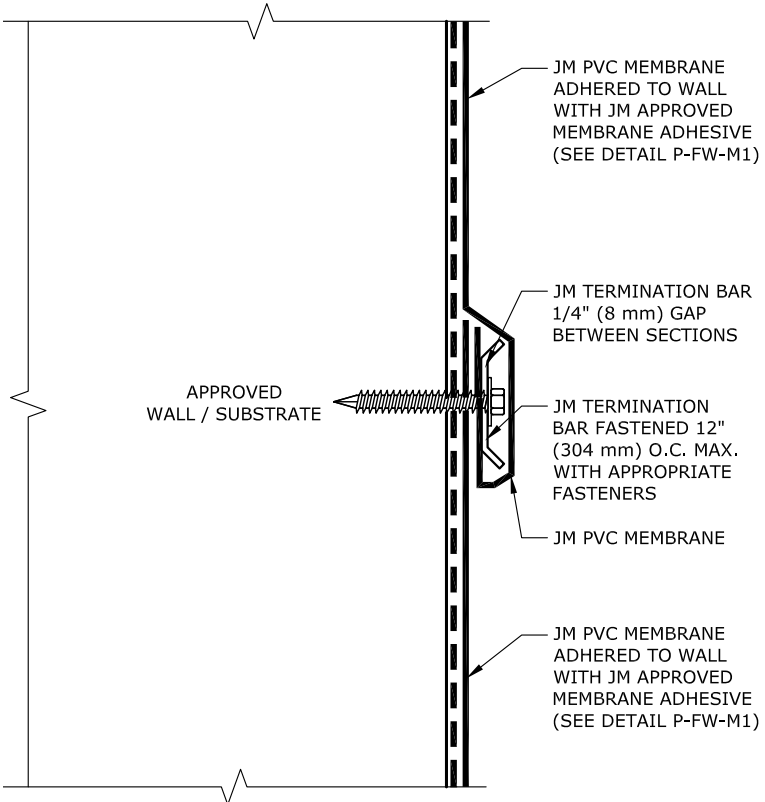

NOTES:

1. REFER TO JOHNS MANVILLE WEBSITE (www.jm.com) FOR MOST UP-TO-DATE INFORMATION.
2. PLEASE SEE SINGLE PLY FLASHING SPECIFICATIONS FOR A FULL DESCRIPTION OF INSTALLATION INSTRUCTIONS AND REQUIREMENTS WHICH ARE CONSIDERED A PART OF THIS DETAIL.
3. ANY CARPENTRY OR METAL WORK SHOULD BE DESIGNED AND CONSTRUCTED IN ACCORDANCE WITH LOCAL CODE REQUIREMENTS AND/OR PROJECT SPECIFICATIONS. THESE COMPONENTS SHOULD BE REVIEWED AND APPROVED BY A LICENSED DESIGN PROFESSIONAL.
4. A SUFFICIENT BACKER FASTENING STRIP MUST BE INSTALLED BEHIND SUBSTRATES DIRECTLY TO STUDS FOR INSTALLATION OF TERMINATION BARS AND FLASHING WHEN SUBSTRATES WILL NOT SUPPORT A PROPER, SECURE INSTALLATION.

Maximum Guarantee Term: 30 Year

Johns Manville is a manufacturer of commercial roofing products and offers this general conceptual information to you as a courtesy. This complimentary assistance is not to be used or relied upon by anyone as a substitute for professional engineering design and documentation required by building code, contract, or applicable law. By accepting these comments you agree they do not constitute any representations, endorsements of, or an assumption by Johns Manville of any liability for either the adequacy of design of this building or any other material not supplied by Johns Manville.

Note: For the most current information on general guidelines, please refer to the System Considerations tab under Commercial Roofing Products on the JM Roofing Web site. For specifications, flashing details and general installation information please refer to the Application Tools tab.

Refer to the Safe Use Instructions and product label prior to using this product.



PVC Intermediate Termination with Counterflashing & Cut-In Reglet

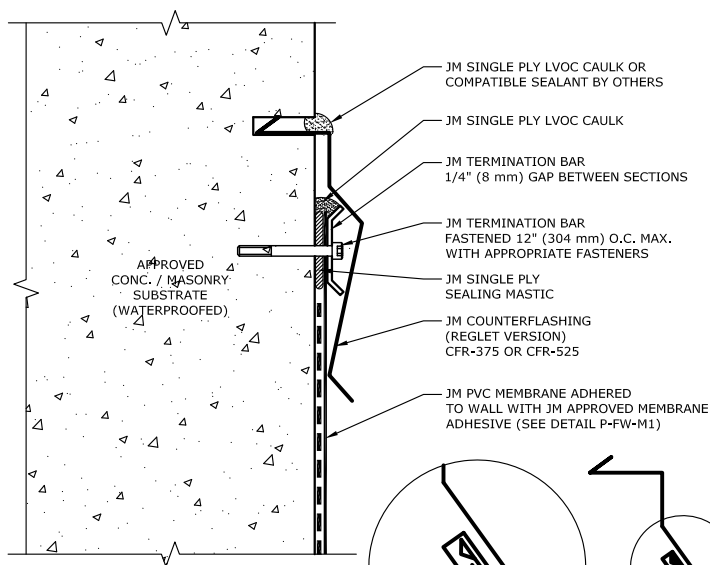

NOTES:

1. REFER TO JOHNS MANVILLE WEBSITE (www.jm.com) FOR MOST UP-TO-DATE INFORMATION.
2. PLEASE SEE JM SINGLE PLY FLASHING SPECIFICATIONS FOR A FULL DESCRIPTION OF INSTALLATION INSTRUCTIONS AND REQUIREMENTS WHICH ARE CONSIDERED A PART OF THIS DETAIL.
3. ANY CARPENTRY OR METAL WORK SHOULD BE DESIGNED AND CONSTRUCTED IN ACCORDANCE WITH LOCAL CODE REQUIREMENTS AND/OR PROJECT SPECIFICATIONS. THESE COMPONENTS SHOULD BE REVIEWED AND APPROVED BY A LICENSED DESIGN PROFESSIONAL.
4. ALL SEALANTS / CAULKING SHALL BE PERIODICALLY INSPECTED AND MAINTAINED BY THE BUILDING OWNER THROUGHOUT THE LIFE OF THE ROOF.
5. TO ASSURE SURFACE MOUNTED TERMINATION PERFORM EFFECTIVELY, WATERPROOF AND MAINTAIN CONCRETE AND MASONRY SUBSTRATES.
6. MINIMUM FLASHING HEIGHT IS 8" (203 mm) ABOVE ROOF SURFACE.

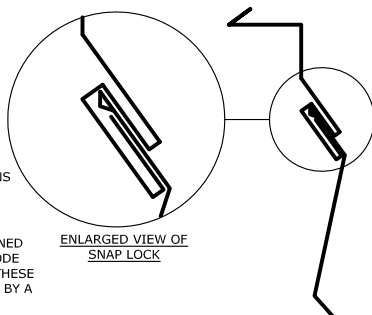

OPTIONAL JM 2 PIECE COUNTERFLASHING REGLET VERSION (CFR2-500)

Maximum Guarantee Term: 30 Year

Johns Manville is a manufacturer of commercial roofing products and offers this general conceptual information to you as a courtesy. This complimentary assistance is not to be used or relied upon by anyone as a substitute for professional engineering design and documentation required by building code, contract, or applicable law. By accepting these comments you agree they do not constitute any representations, endorsements of, or an assumption by Johns Manville of any liability for either the adequacy of design of this building or any other material not supplied by Johns Manville.

Note: For the most current information on general guidelines, please refer to the System Considerations tab under Commercial Roofing Products on the JM Roofing Web site. For specifications, flashing details and general installation information please refer to the Application Tools tab.

Refer to the Safe Use Instructions and product label prior to using this product.



PVC Intermediate Termination with Surface Mounted Counterflashing

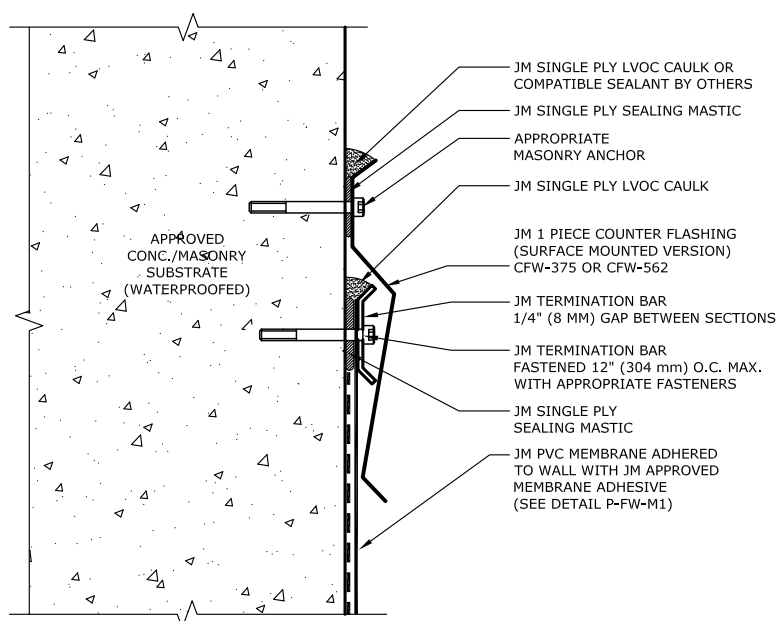

NOTES:

1. REFER TO JOHNS MANVILLE WEBSITE (www.jm.com) FOR MOST UP-TO-DATE INFORMATION.
2. PLEASE SEE JM SINGLE PLY FLASHING SPECIFICATIONS AND FOR A FULL DESCRIPTION OF INSTALLATION INSTRUCTIONS AND REQUIREMENTS WHICH ARE CONSIDERED A PART OF THIS DETAIL.
3. ANY CARPENTRY OR METAL WORK SHOULD BE DESIGNED AND CONSTRUCTED IN ACCORDANCE WITH LOCAL CODE REQUIREMENTS AND/OR PROJECT SPECIFICATIONS. THESE COMPONENTS SHOULD BE REVIEWED AND APPROVED BY A LICENSED DESIGN PROFESSIONAL.
4. ALL SEALANTS / CAULKING SHALL BE PERIODICALLY INSPECTED AND MAINTAINED BY THE BUILDING OWNER THROUGHOUT THE LIFE OF THE ROOF.
5. TO ASSURE SURFACE MOUNTED TERMINATIONS PERFORM EFFECTIVELY, WATERPROOF AND MAINTAIN CONCRETE AND MASONRY SUBSTRATES.
6. MINIMUM FLASHING HEIGHT IS 8" (203 mm) ABOVE ROOF SURFACE.

Maximum Guarantee Term: 30 Year

Johns Manville is a manufacturer of commercial roofing products and offers this general conceptual information to you as a courtesy. This complimentary assistance is not to be used or relied upon by anyone as a substitute for professional engineering design and documentation required by building code, contract, or applicable law. By accepting these comments you agree they do not constitute any representations, endorsements of, or an assumption by Johns Manville of any liability for either the adequacy of design of this building or any other material not supplied by Johns Manville.

Note: For the most current information on general guidelines, please refer to the System Considerations tab under Commercial Roofing Products on the JM Roofing Web site. For specifications, flashing details and general installation information please refer to the Application Tools tab.

Refer to the Safe Use Instructions and product label prior to using this product.



PVC Intermediate Termination with Thru Wall Counterflashing

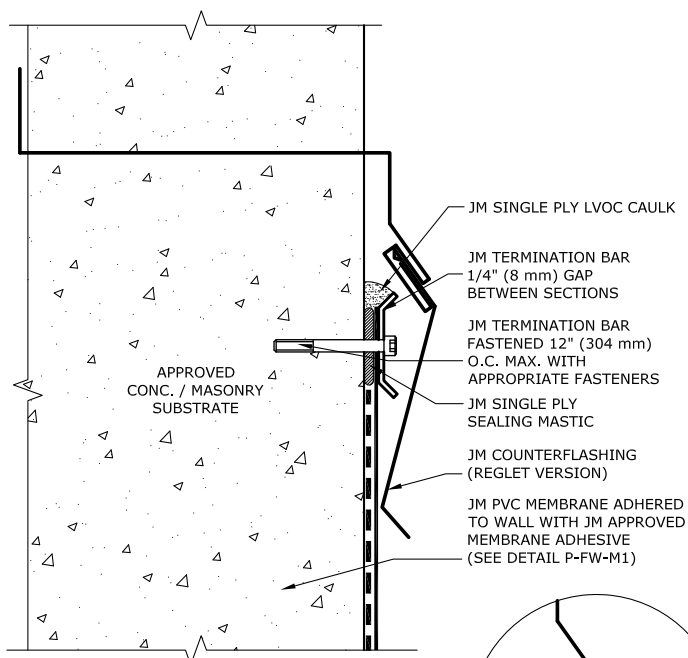

NOTES:

1. REFER TO JOHNS MANVILLE WEBSITE (www.jm.com) FOR MOST UP-TO-DATE INFORMATION.
2. PLEASE SEE JM SINGLE PLY FLASHING SPECIFICATIONS FOR A FULL DESCRIPTION OF INSTALLATION INSTRUCTIONS AND REQUIREMENTS WHICH ARE CONSIDERED A PART OF THIS DETAIL.
3. ANY CARPENTRY OR METAL WORK SHOULD BE DESIGNED AND CONSTRUCTED IN ACCORDANCE WITH LOCAL CODE REQUIREMENTS AND/OR PROJECT SPECIFICATIONS. THESE COMPONENTS SHOULD BE REVIEWED AND APPROVED BY A LICENSED DESIGN PROFESSIONAL.
4. ALL SEALANTS / CAULKING SHALL BE PERIODICALLY INSPECTED AND MAINTAINED BY THE BUILDING OWNER THROUGHOUT THE LIFE OF THE ROOF.
5. TO ASSURE SURFACE MOUNTED TERMINATION PERFORM EFFECTIVELY, WATERPROOF AND MAINTAIN CONCRETE AND MASONRY SUBSTRATES.
6. MINIMUM FLASHING HEIGHT IS 8" (203 mm) ABOVE ROOF SURFACE.

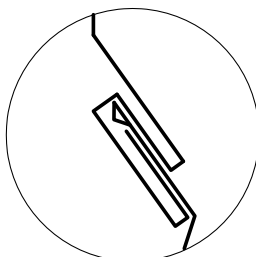

ENLARGED VIEW OF
SNAP LOCK

Maximum Guarantee Term: 30 Year

Johns Manville is a manufacturer of commercial roofing products and offers this general conceptual information to you as a courtesy. This complimentary assistance is not to be used or relied upon by anyone as a substitute for professional engineering design and documentation required by building code, contract, or applicable law. By accepting these comments you agree they do not constitute any representations, endorsements of, or an assumption by Johns Manville of any liability for either the adequacy of design of this building or any other material not supplied by Johns Manville.

Note: For the most current information on general guidelines, please refer to the System Considerations tab under Commercial Roofing Products on the JM Roofing Web site. For specifications, flashing details and general installation information please refer to the Application Tools tab.

Refer to the Safe Use Instructions and product label prior to using this product.



PVC Intermediate Termination With Termination Bar

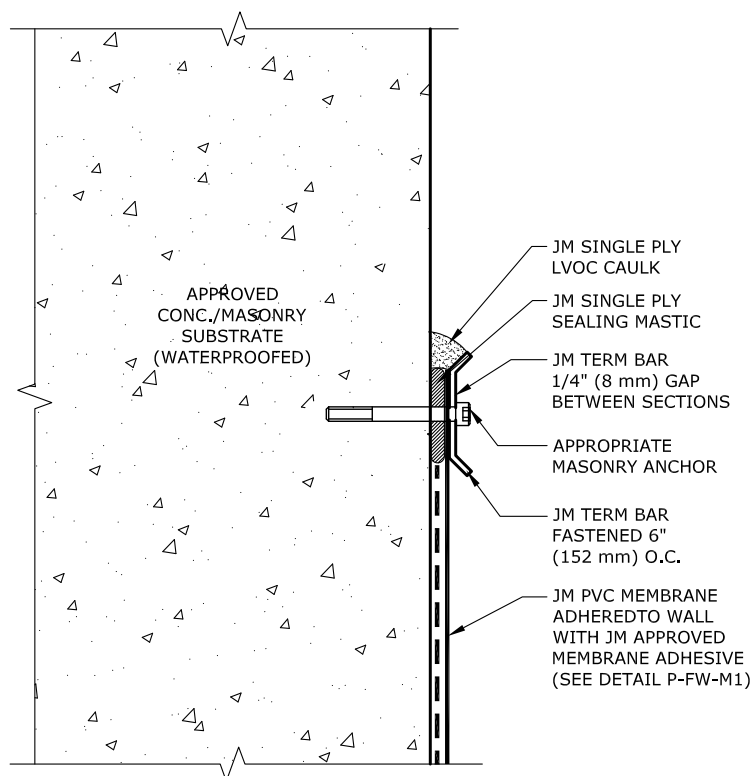

NOTES:

1. REFER TO JOHNS MANVILLE WEBSITE (www.jm.com) FOR MOST UP-TO-DATE INFORMATION.
2. PLEASE SEE JM SINGLE PLY FLASHING SPECIFICATIONS FOR A FULL DESCRIPTION OF INSTALLATION INSTRUCTIONS AND REQUIREMENTS WHICH ARE CONSIDERED A PART OF THIS DETAIL.
3. ANY CARPENTRY OR METAL WORK SHOULD BE DESIGNED AND CONSTRUCTED IN ACCORDANCE WITH LOCAL CODE REQUIREMENTS AND/OR PROJECT SPECIFICATIONS. THESE COMPONENTS SHOULD BE REVIEWED AND APPROVED BY A LICENSED DESIGN PROFESSIONAL.
4. ALL SEALANTS / CAULKING SHALL BE PERIODICALLY INSPECTED AND MAINTAINED BY THE BUILDING OWNER THROUGHOUT THE LIFE OF THE ROOF.
5. TO ASSURE SURFACE MOUNTED TERMINATIONS PERFORM EFFECTIVELY, WATERPROOF AND MAINTAIN CONCRETE AND MASONRY SUBSTRATES.
6. MINIMUM FLASHING HEIGHT IS 8" (203 mm) ABOVE ROOF SURFACE.

Maximum Guarantee Term: 20 Year

Johns Manville is a manufacturer of commercial roofing products and offers this general conceptual information to you as a courtesy. This complimentary assistance is not to be used or relied upon by anyone as a substitute for professional engineering design and documentation required by building code, contract, or applicable law. By accepting these comments you agree they do not constitute any representations, endorsements of, or an assumption by Johns Manville of any liability for either the adequacy of design of this building or any other material not supplied by Johns Manville.

Note: For the most current information on general guidelines, please refer to the System Considerations tab under Commercial Roofing Products on the JM Roofing Web site. For specifications, flashing details and general installation information please refer to the Application Tools tab.

Refer to the Safe Use Instructions and product label prior to using this product.



PVC Intermediate Termination Below Wall Cladding

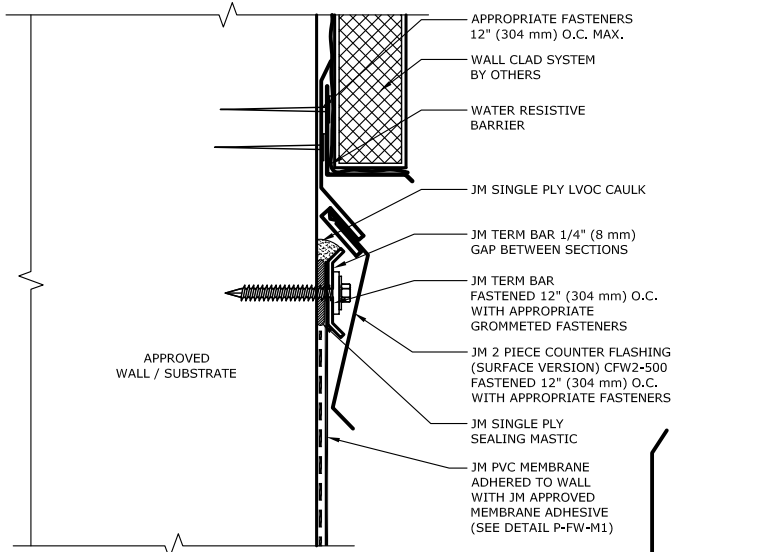

NOTES:

1. REFER TO JOHNS MANVILLE WEBSITE (www.jm.com) FOR MOST UP-TO-DATE INFORMATION.
2. PLEASE SEE JM SINGLE PLY FLASHING SPECIFICATIONS FOR A FULL DESCRIPTION OF INSTALLATION INSTRUCTIONS AND REQUIREMENTS WHICH ARE CONSIDERED A PART OF THIS DETAIL.
3. ANY CARPENTRY OR METAL WORK SHOULD BE DESIGNED AND CONSTRUCTED IN ACCORDANCE WITH LOCAL CODE REQUIREMENTS AND/OR PROJECT SPECIFICATIONS. THESE COMPONENTS SHOULD BE REVIEWED AND APPROVED BY A LICENSED DESIGN PROFESSIONAL.
4. ALL SEALANTS / CAULKING SHALL BE PERIODICALLY INSPECTED AND MAINTAINED BY THE BUILDING OWNER THROUGHOUT THE LIFE OF THE ROOF.
5. MINIMUM FLASHING HEIGHT IS 8" ABOVE ROOF SURFACE.

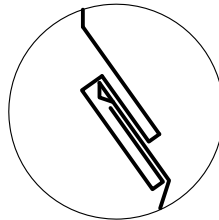

ENLARGED VIEW OF SNAP LOCK

OPTIONAL JM 1 PIECE COUNTERFLASHING SURFACE VERSION (CFW-375 & CFW-562)

Maximum Guarantee Term: 20 Year

Johns Manville is a manufacturer of commercial roofing products and offers this general conceptual information to you as a courtesy. This complimentary assistance is not to be used or relied upon by anyone as a substitute for professional engineering design and documentation required by building code, contract, or applicable law. By accepting these comments you agree they do not constitute any representations, endorsements of, or an assumption by Johns Manville of any liability for either the adequacy of design of this building or any other material not supplied by Johns Manville.

Note: For the most current information on general guidelines, please refer to the System Considerations tab under Commercial Roofing Products on the JM Roofing Web site. For specifications, flashing details and general installation information please refer to the Application Tools tab.

Refer to the Safe Use Instructions and product label prior to using this product.



PVC Intermediate Membrane Attachment With Termination Bar

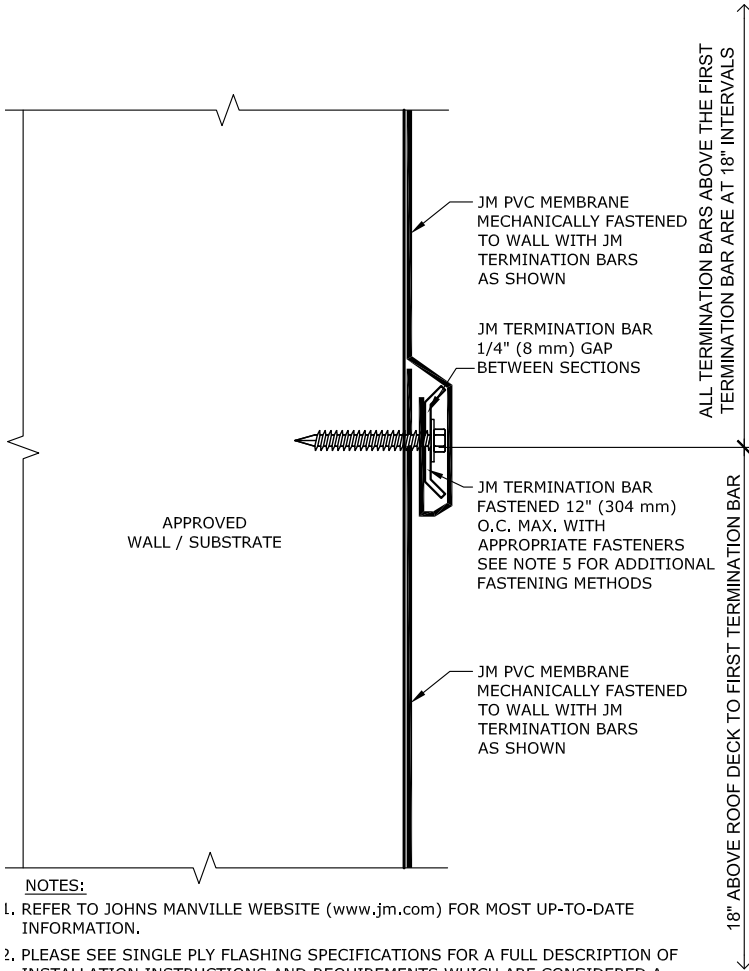

NOTES:

1. REFER TO JOHNS MANVILLE WEBSITE (www.jm.com) FOR MOST UP-TO-DATE INFORMATION.
2. PLEASE SEE SINGLE PLY FLASHING SPECIFICATIONS FOR A FULL DESCRIPTION OF INSTALLATION INSTRUCTIONS AND REQUIREMENTS WHICH ARE CONSIDERED A PART OF THIS DETAIL.
3. ANY CARPENTRY OR METAL WORK SHOULD BE DESIGNED AND CONSTRUCTED IN ACCORDANCE WITH LOCAL CODE REQUIREMENTS AND/OR PROJECT SPECIFICATIONS. THESE COMPONENTS SHOULD BE REVIEWED AND APPROVED BY A LICENSED DESIGN PROFESSIONAL.
4. A SUFFICIENT BACKER FASTENING STRIP MUST BE INSTALLED BEHIND SUBSTRATES DIRECTLY TO STUDS FOR INSTALLATION OF TERMINATION BARS, BATTEN STRIPS, AND FLASHINGS WHEN SUBSTRATES WILL NOT SUPPORT A PROPER, SECURE INSTALLATION. SEE DETAIL P-FW-M2I FOR HIGH WALL FASTENING METHODS.
5. SEE DETAILS P-FW-I1 THROUGH P-FW-I5 FOR ALL APPROVED JM INTERMEDIATE FASTENING METHODS.

Maximum Guarantee Term: 30 Year

Johns Manville is a manufacturer of commercial roofing products and offers this general conceptual information to you as a courtesy. This complimentary assistance is not to be used or relied upon by anyone as a substitute for professional engineering design and documentation required by building code, contract, or applicable law. By accepting these comments you agree they do not constitute any representations, endorsements of, or an assumption by Johns Manville of any liability for either the adequacy of design of this building or any other material not supplied by Johns Manville.

Note: For the most current information on general guidelines, please refer to the System Considerations tab under Commercial Roofing Products on the JM Roofing Web site. For specifications, flashing details and general installation information please refer to the Application Tools tab.

Refer to the Safe Use Instructions and product label prior to using this product.



PVC Intermediate Termination (Loose Hung Flashing)

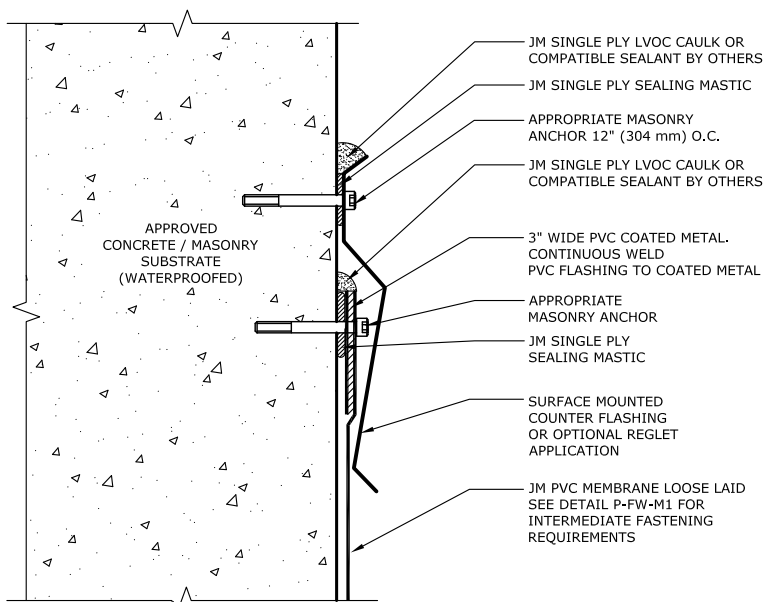

NOTES:

1. REFER TO JOHNS MANVILLE WEBSITE (www.jm.com) FOR MOST UP-TO-DATE INFORMATION.
2. PLEASE SEE JM SINGLE PLY FLASHING SPECIFICATIONS AND FOR A FULL DESCRIPTION OF INSTALLATION INSTRUCTIONS AND REQUIREMENTS WHICH ARE CONSIDERED A PART OF THIS DETAIL.
3. ANY CARPENTRY OR METAL WORK SHOULD BE DESIGNED AND CONSTRUCTED IN ACCORDANCE WITH LOCAL CODE REQUIREMENTS AND/OR PROJECT SPECIFICATIONS. THESE COMPONENTS SHOULD BE REVIEWED AND APPROVED BY A LICENSED DESIGN PROFESSIONAL.
4. ALL SEALANTS / CAULKING SHALL BE PERIODICALLY INSPECTED AND MAINTAINED BY THE BUILDING OWNER THROUGHOUT THE LIFE OF THE ROOF.
5. TO ASSURE SURFACE MOUNTED TERMINATIONS PERFORM EFFECTIVELY, WATERPROOF AND MAINTAIN CONCRETE AND MASONRY SUBSTRATES.
6. MINIMUM FLASHING HEIGHT IS 8" (203 mm) ABOVE ROOF SURFACE. INTERMEDIATE FLASHING FASTENING HEIGHT FOR NON-ADHERED MEMBRANE IS 18" (457 mm) MAXIMUM AND AT 18" (457 mm) INTERVALS.

Maximum Guarantee Term: 20 Year

Johns Manville is a manufacturer of commercial roofing products and offers this general conceptual information to you as a courtesy. This complimentary assistance is not to be used or relied upon by anyone as a substitute for professional engineering design and documentation required by building code, contract, or applicable law. By accepting these comments you agree they do not constitute any representations, endorsements of, or an assumption by Johns Manville of any liability for either the adequacy of design of this building or any other material not supplied by Johns Manville.

Note: For the most current information on general guidelines, please refer to the System Considerations tab under Commercial Roofing Products on the JM Roofing Web site. For specifications, flashing details and general installation information please refer to the Application Tools tab.

Refer to the Safe Use Instructions and product label prior to using this product.



Fabricated Metal Coping Over Adhered PVC

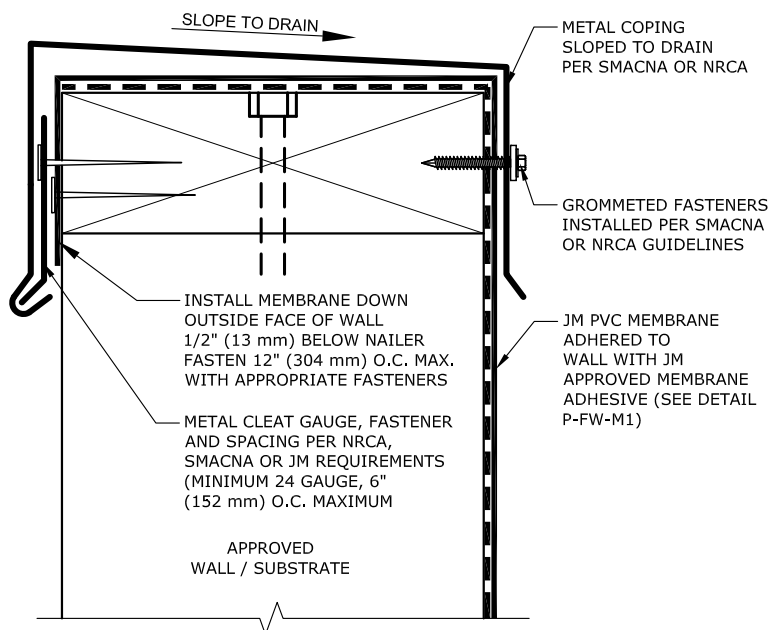

NOTES:

1. REFER TO JOHNS MANVILLE WEBSITE (www.jm.com) FOR MOST UP-TO-DATE INFORMATION.
2. PLEASE SEE SINGLE PLY FLASHING SPECIFICATIONS FOR A FULL DESCRIPTION OF INSTALLATION INSTRUCTIONS AND REQUIREMENTS WHICH ARE CONSIDERED A PART OF THIS DETAIL.
3. ANY CARPENTRY OR METAL WORK SHOULD BE DESIGNED AND CONSTRUCTED IN ACCORDANCE WITH LOCAL CODE REQUIREMENTS AND/OR PROJECT SPECIFICATIONS. THESE COMPONENTS SHOULD BE REVIEWED AND APPROVED BY A LICENSED DESIGN PROFESSIONAL.

Maximum Guarantee Term: 20 Year

Johns Manville is a manufacturer of commercial roofing products and offers this general conceptual information to you as a courtesy. This complimentary assistance is not to be used or relied upon by anyone as a substitute for professional engineering design and documentation required by building code, contract, or applicable law. By accepting these comments you agree they do not constitute any representations, endorsements of, or an assumption by Johns Manville of any liability for either the adequacy of design of this building or any other material not supplied by Johns Manville.

Note: For the most current information on general guidelines, please refer to the System Considerations tab under Commercial Roofing Products on the JM Roofing Web site. For specifications, flashing details and general installation information please refer to the Application Tools tab.

Refer to the Safe Use Instructions and product label prior to using this product.



Presto Lock Coping System Over PVC

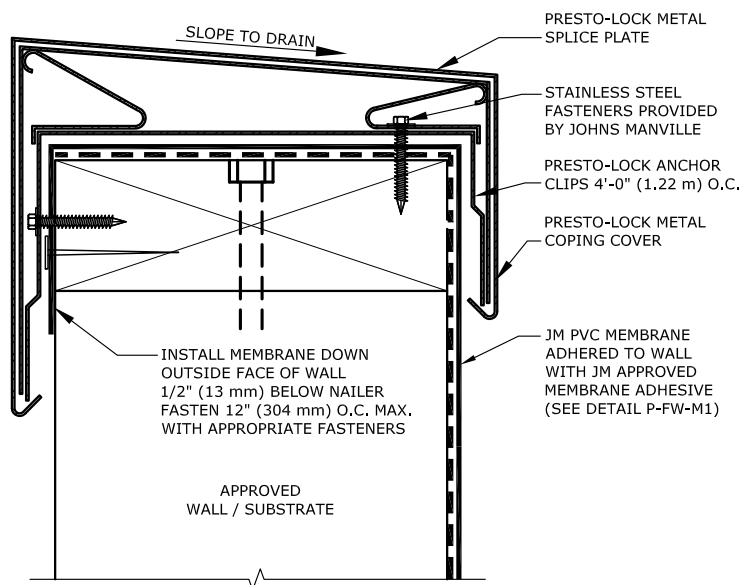

NOTES:

1. REFER TO JOHNS MANVILLE WEBSITE (www.jm.com) FOR MOST UP-TO-DATE INFORMATION.
2. PLEASE SEE SINGLE PLY FLASHING SPECIFICATIONS FOR A FULL DESCRIPTION OF INSTALLATION INSTRUCTIONS AND REQUIREMENTS WHICH ARE CONSIDERED A PART OF THIS DETAIL.
3. ANY CARPENTRY OR METAL WORK SHOULD BE DESIGNED AND CONSTRUCTED IN ACCORDANCE WITH LOCAL CODE REQUIREMENTS AND/OR PROJECT SPECIFICATIONS. THESE COMPONENTS SHOULD BE REVIEWED AND APPROVED BY A LICENSED DESIGN PROFESSIONAL.
4. REFER TO JM PRESTO LOCK COPING INSTALLATION INSTRUCTIONS FOR PROPER FASTENING REQUIREMENTS.

Maximum Guarantee Term: 30 Year

Johns Manville is a manufacturer of commercial roofing products and offers this general conceptual information to you as a courtesy. This complimentary assistance is not to be used or relied upon by anyone as a substitute for professional engineering design and documentation required by building code, contract, or applicable law. By accepting these comments you agree they do not constitute any representations, endorsements of, or an assumption by Johns Manville of any liability for either the adequacy of design of this building or any other material not supplied by Johns Manville.

Note: For the most current information on general guidelines, please refer to the System Considerations tab under Commercial Roofing Products on the JM Roofing Web site. For specifications, flashing details and general installation information please refer to the Application Tools tab.

Refer to the Safe Use Instructions and product label prior to using this product.



Presto-Tite Fascia System On Sloped Parapet

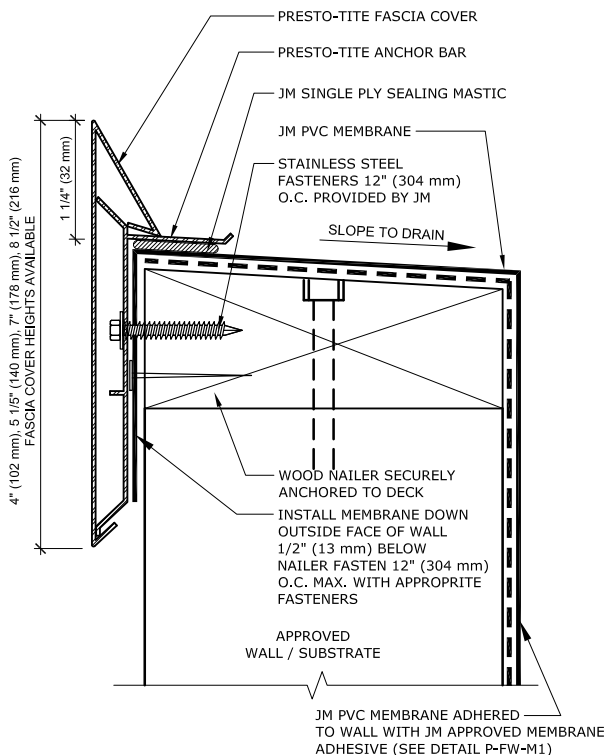

NOTES:

1. REFER TO JOHNS MANVILLE WEBSITE (www.jm.com) FOR MOST UP-TO-DATE INFORMATION.
2. PLEASE SEE SINGLE PLY FLASHING SPECIFICATIONS FOR A FULL DESCRIPTION OF INSTALLATION INSTRUCTIONS AND REQUIREMENTS WHICH ARE CONSIDERED PART OF THIS DETAIL.
3. ANY CARPENTRY OR METAL WORK SHOULD BE DESIGNED AND CONSTRUCTED IN ACCORDANCE WITH LOCAL CODE REQUIREMENTS AND/OR PROJECT SPECIFICATIONS. THESE COMPONENTS SHOULD BE REVIEWED AND APPROVED BY A LICENSED DESIGN PROFESSIONAL.
4. REFER TO JM PRESTO TITE FASCIA INSTALLATION INSTRUCTIONS FOR PROPER FASTENING REQUIREMENTS.
5. THE PRESTO-TITE FASCIA SYSTEM SHOWN IS FOR SINGLE PLY ROOF SYSTEMS ONLY.

Maximum Guarantee Term: 30 Year

Johns Manville is a manufacturer of commercial roofing products and offers this general conceptual information to you as a courtesy. This complimentary assistance is not to be used or relied upon by anyone as a substitute for professional engineering design and documentation required by building code, contract, or applicable law. By accepting these comments you agree they do not constitute any representations, endorsements of, or an assumption by Johns Manville of any liability for either the adequacy of design of this building or any other material not supplied by Johns Manville.

Note: For the most current information on general guidelines, please refer to the System Considerations tab under Commercial Roofing Products on the JM Roofing Web site. For specifications, flashing details and general installation information please refer to the Application Tools tab.

Refer to the Safe Use Instructions and product label prior to using this product.



Perma-Tite Continuous Cleat Coping System Over PVC

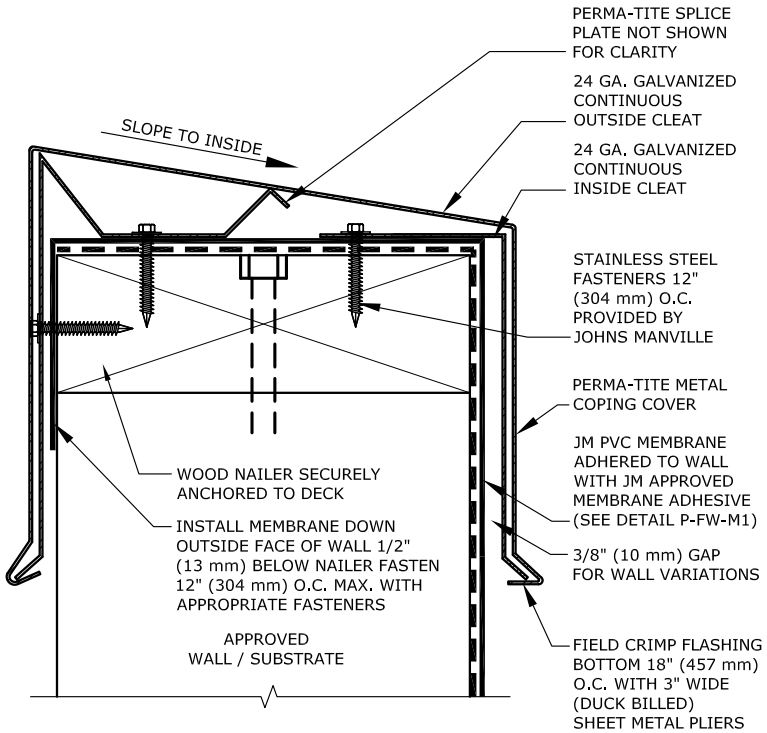

NOTES:

1. REFER TO JOHNS MANVILLE WEBSITE (www.jm.com) FOR MOST UP-TO-DATE INFORMATION.
2. PLEASE SEE SINGLE PLY FLASHING SPECIFICATIONS FOR A FULL DESCRIPTION OF INSTALLATION INSTRUCTIONS AND REQUIREMENTS WHICH ARE CONSIDERED A PART OF THIS DETAIL.
3. ANY CARPENTRY OR METAL WORK SHOULD BE DESIGNED AND CONSTRUCTED IN ACCORDANCE WITH LOCAL CODE REQUIREMENTS AND/OR PROJECT SPECIFICATIONS. THESE COMPONENTS SHOULD BE REVIEWED AND APPROVED BY A LICENSED DESIGN PROFESSIONAL.
4. REFER TO JM PERMA-TITE COPING INSTALLATION INSTRUCTIONS FOR PROPER FASTENING REQUIREMENTS.

Maximum Guarantee Term: 30 Year

Johns Manville is a manufacturer of commercial roofing products and offers this general conceptual information to you as a courtesy. This complimentary assistance is not to be used or relied upon by anyone as a substitute for professional engineering design and documentation required by building code, contract, or applicable law. By accepting these comments you agree they do not constitute any representations, endorsements of, or an assumption by Johns Manville of any liability for either the adequacy of design of this building or any other material not supplied by Johns Manville.

Note: For the most current information on general guidelines, please refer to the System Considerations tab under Commercial Roofing Products on the JM Roofing Web site. For specifications, flashing details and general installation information please refer to the Application Tools tab.

Refer to the Safe Use Instructions and product label prior to using this product.



Cut Edge Sealant

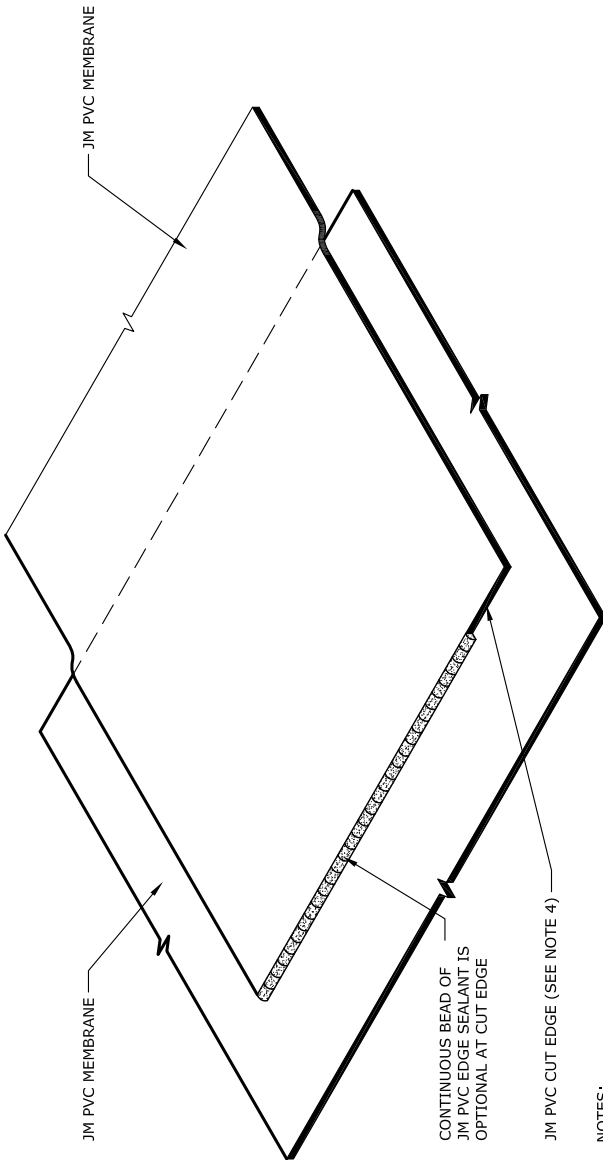

NOTES:

1. REFER TO JOHNS MANVILLE WEBSITE (www.jm.com) FOR MOST UP-TO-DATE INFORMATION.
2. PLEASE SEE SINGLE PLY FLASHING SPECIFICATIONS FOR A FULL DESCRIPTION OF INSTALLATION INSTRUCTIONS AND REQUIREMENTS WHICH ARE CONSIDERED A PART OF THIS DETAIL.
3. ANY CARPENTRY OR METAL WORK SHOULD BE DESIGNED AND CONSTRUCTED IN ACCORDANCE WITH LOCAL CODE REQUIREMENTS AND/OR PROJECT SPECIFICATIONS. THESE COMPONENTS SHOULD BE REVIEWED AND APPROVED BY A LICENSED DESIGN PROFESSIONAL.
4. JM PVC EDGE SEALANT IS OPTIONAL ON CUT OR NON ENCAPSULATED EDGES OF PVC REINFORCED MEMBRANE. THIS INCLUDES FACTORY CUT MEMBRANE.

Maximum Guarantee Term: 30 Year

Johns Manville is a manufacturer of commercial roofing products and offers this general conceptual information to you as a courtesy. This complimentary assistance is not to be used or relied upon by anyone as a substitute for professional engineering design and documentation required by building code, contract, or applicable law. By accepting these comments you agree they do not constitute any representations, endorsements of, or an assumption by Johns Manville of any liability for either the adequacy of design of this building or any other material not supplied by Johns Manville.

Note: For the most current information on general guidelines, please refer to the System Considerations tab under Commercial Roofing Products on the JM Roofing Web site. For specifications, flashing details and general installation information please refer to the Application Tools tab.

Refer to the Safe Use Instructions and product label prior to using this product.



In Lap Fastening Method - Steel Deck

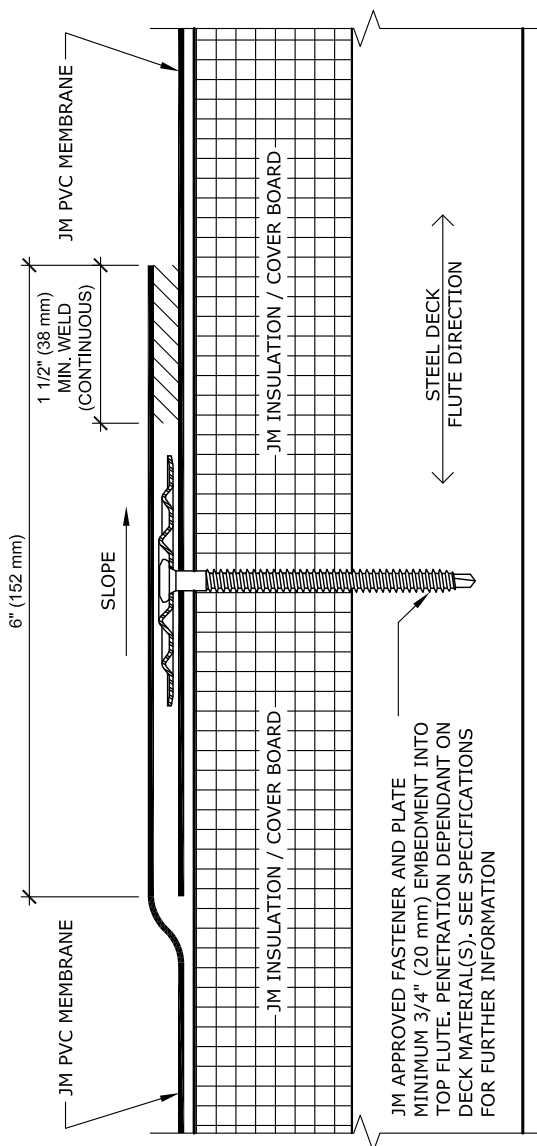

NOTES:

1. REFER TO JOHNS MANVILLE WEBSITE (www.jm.com) FOR MOST UP-TO-DATE INFORMATION.
2. PLEASE SEE SINGLE PLY FLASHING SPECIFICATIONS FOR A FULL DESCRIPTION OF INSTALLATION INSTRUCTIONS AND REQUIREMENTS WHICH ARE CONSIDERED A PART OF THIS DETAIL.
3. ANY CARPENTRY OR METAL WORK SHOULD BE DESIGNED AND CONSTRUCTED IN ACCORDANCE WITH LOCAL CODE REQUIREMENTS AND/OR PROJECT SPECIFICATIONS. THESE COMPONENTS SHOULD BE REVIEWED AND APPROVED BY A LICENSED DESIGN PROFESSIONAL.
4. JM PVC EDGE SEALANT IS OPTIONAL ON ALL CUT OR NON-ENCAPSULATED EDGES OF REINFORCED MEMBRANE. THIS INCLUDES FACTORY CUT MEMBRANE (SEE DETAIL P-MS-01).

Maximum Guarantee Term: 30 Year

Johns Manville is a manufacturer of commercial roofing products and offers this general conceptual information to you as a courtesy. This complimentary assistance is not to be used or relied upon by anyone as a substitute for professional engineering design and documentation required by building code, contract, or applicable law. By accepting these comments you agree they do not constitute any representations, endorsements of, or an assumption by Johns Manville of any liability for either the adequacy of design of this building or any other material not supplied by Johns Manville.

Note: For the most current information on general guidelines, please refer to the System Considerations tab under Commercial Roofing Products on the JM Roofing Web site. For specifications, flashing details and general installation information please refer to the Application Tools tab.

Refer to the Safe Use Instructions and product label prior to using this product.



In Lap Fastening Method - Plywood Deck

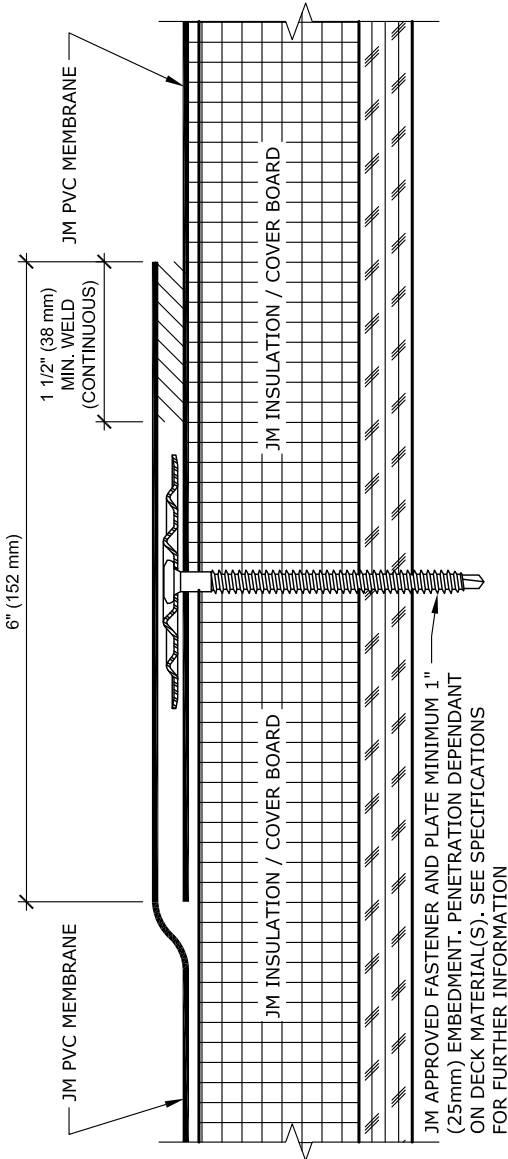

NOTES:

1. REFER TO JOHNS MANVILLE WEBSITE (www.jm.com) FOR MOST UP-TO-DATE INFORMATION.
2. PLEASE SEE SINGLE PLY FLASHING SPECIFICATIONS FOR A FULL DESCRIPTION OF INSTALLATION INSTRUCTIONS AND REQUIREMENTS WHICH ARE CONSIDERED A PART OF THIS DETAIL.
3. ANY CARPENTRY OR METAL WORK SHOULD BE DESIGNED AND CONSTRUCTED IN ACCORDANCE WITH LOCAL CODE REQUIREMENTS AND/OR PROJECT SPECIFICATIONS. THESE COMPONENTS SHOULD BE REVIEWED AND APPROVED BY A LICENSED DESIGN PROFESSIONAL.
4. JM PVC EDGE SEALANT IS OPTIONAL ON ALL CUT OR NON-ENCAPSULATED EDGES OF REINFORCED MEMBRANE. THIS INCLUDES FACTORY CUT MEMBRANE (SEE DETAIL P-MS-01).

Maximum Guarantee Term: 30 Year

Johns Manville is a manufacturer of commercial roofing products and offers this general conceptual information to you as a courtesy. This complimentary assistance is not to be used or relied upon by anyone as a substitute for professional engineering design and documentation required by building code, contract, or applicable law. By accepting these comments you agree they do not constitute any representations, endorsements of, or an assumption by Johns Manville of any liability for either the adequacy of design of this building or any other material not supplied by Johns Manville.

Note: For the most current information on general guidelines, please refer to the System Considerations tab under Commercial Roofing Products on the JM Roofing Web site. For specifications, flashing details and general installation information please refer to the Application Tools tab.

Refer to the Safe Use Instructions and product label prior to using this product.



In Lap Fastening Method - Concrete Deck

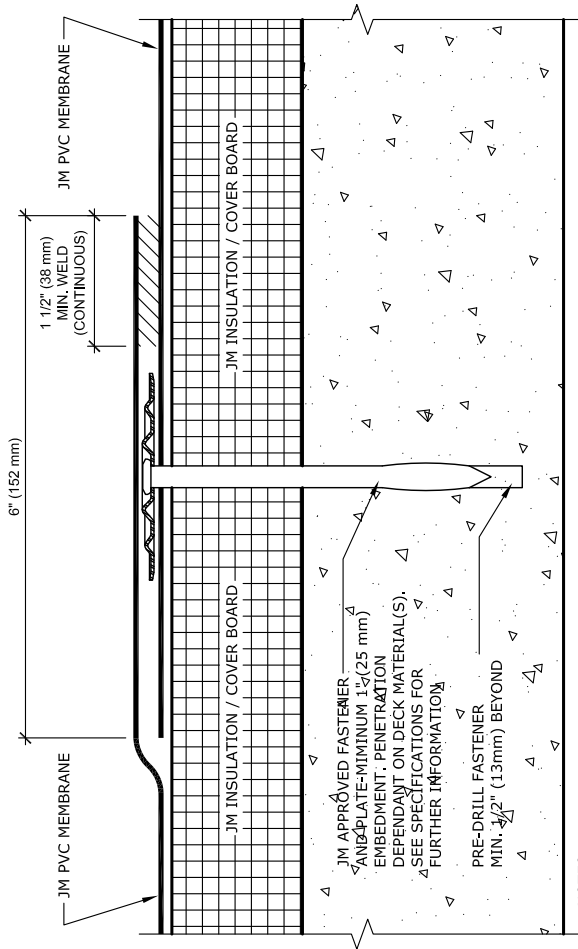

NOTES:

1. REFER TO JOHNS MANVILLE WEBSITE (www.jm.com) FOR MOST UP-TO-DATE INFORMATION.
2. PLEASE SEE SINGLE PLY FLASHING SPECIFICATIONS FOR A FULL DESCRIPTION OF INSTALLATION INSTRUCTIONS AND REQUIREMENTS WHICH ARE CONSIDERED A PART OF THIS DETAIL.
3. ANY CARPENTRY OR METAL WORK SHOULD BE DESIGNED AND CONSTRUCTED IN ACCORDANCE WITH LOCAL CODE REQUIREMENTS AND/OR PROJECT SPECIFICATIONS. THESE COMPONENTS SHOULD BE REVIEWED AND APPROVED BY A LICENSED DESIGN PROFESSIONAL.
4. JM PVC EDGE SEALANT IS OPTIONAL ON ALL CUT OR NON-ENCAPSULATED EDGES OF REINFORCED MEMBRANE. THIS INCLUDES FACTORY CUT MEMBRANE (SEE DETAIL P-MS-01).

Maximum Guarantee Term: 20 Year

Johns Manville is a manufacturer of commercial roofing products and offers this general conceptual information to you as a courtesy. This complimentary assistance is not to be used or relied upon by anyone as a substitute for professional engineering design and documentation required by building code, contract, or applicable law. By accepting these comments you agree they do not constitute any representations, endorsements of, or an assumption by Johns Manville of any liability for either the adequacy of design of this building or any other material not supplied by Johns Manville.

Note: For the most current information on general guidelines, please refer to the System Considerations tab under Commercial Roofing Products on the JM Roofing Web site. For specifications, flashing details and general installation information please refer to the Application Tools tab.

Refer to the Safe Use Instructions and product label prior to using this product.



In Lap Fastening Method - Wood Plank Deck

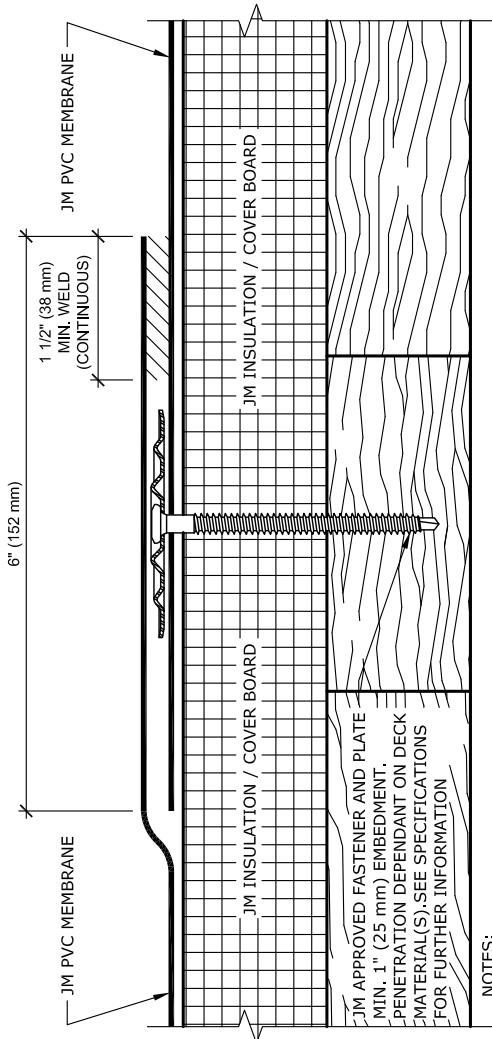

NOTES:

1. REFER TO JOHNS MANVILLE WEBSITE (www.jm.com) FOR MOST UP-TO-DATE INFORMATION.
2. PLEASE SEE SINGLE PLY FLASHING SPECIFICATIONS FOR A FULL DESCRIPTION OF INSTALLATION INSTRUCTIONS AND REQUIREMENTS WHICH ARE CONSIDERED A PART OF THIS DETAIL.
3. ANY CARPENTRY OR METAL WORK SHOULD BE DESIGNED AND CONSTRUCTED IN ACCORDANCE WITH LOCAL CODE REQUIREMENTS AND/OR PROJECT SPECIFICATIONS. THESE COMPONENTS SHOULD BE REVIEWED AND APPROVED BY A LICENSED DESIGN PROFESSIONAL.
4. JM PVC EDGE SEALANT IS OPTIONAL ON ALL CUT OR NON-ENCAPSULATED EDGES OF REINFORCED MEMBRANE. THIS INCLUDES FACTORY CUT MEMBRANE (SEE DETAIL P-MS-01).

Maximum Guarantee Term: 30 Year

Johns Manville is a manufacturer of commercial roofing products and offers this general conceptual information to you as a courtesy. This complimentary assistance is not to be used or relied upon by anyone as a substitute for professional engineering design and documentation required by building code, contract, or applicable law. By accepting these comments you agree they do not constitute any representations, endorsements of, or an assumption by Johns Manville of any liability for either the adequacy of design of this building or any other material not supplied by Johns Manville.

Note: For the most current information on general guidelines, please refer to the System Considerations tab under Commercial Roofing Products on the JM Roofing Web site. For specifications, flashing details and general installation information please refer to the Application Tools tab.

Refer to the Safe Use Instructions and product label prior to using this product.



Continuous Strip Fastening Method

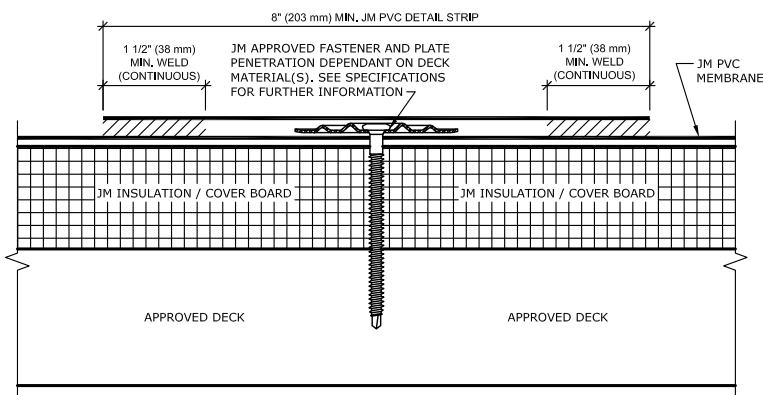
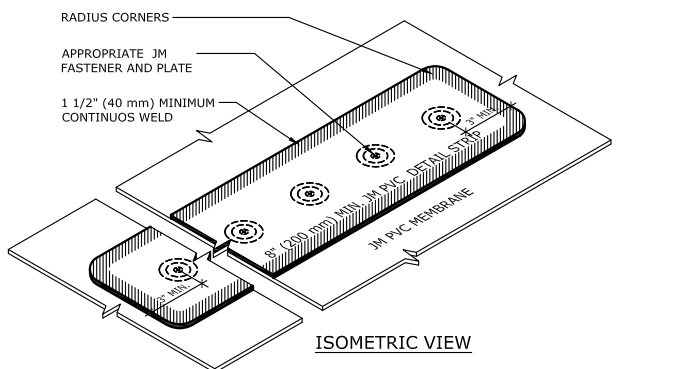

NOTES:

1. REFER TO JOHNS MANVILLE WEBSITE (www.Jm.com) FOR MOST UP-TO-DATE INFORMATION.
2. PLEASE SEE SINGLE PLY FLASHING SPECIFICATIONS FOR A FULL DESCRIPTION OF INSTALLATION INSTRUCTIONS AND REQUIREMENTS WHICH ARE CONSIDERED A PART OF THIS DETAIL.
3. ANY CARPENTRY OR METAL WORK SHOULD BE DESIGNED AND CONSTRUCTED IN ACCORDANCE WITH LOCAL CODE REQUIREMENTS AND/OR PROJECT SPECIFICATIONS. THESE COMPONENTS SHOULD BE REVIEWED AND APPROVED BY A LICENSED DESIGN PROFESSIONAL.
4. JM PVC EDGE SEALANT IS OPTIONAL ON ALL CUT OR NON-ENCAPSULATED EDGES OF REINFORCED MEMBRANE. THIS INCLUDES FACTORY CUT MEMBRANE (SEE DETAIL P-MS-01).

Maximum Guarantee Term: 30 Year

Johns Manville is a manufacturer of commercial roofing products and offers this general conceptual information to you as a courtesy. This complimentary assistance is not to be used or relied upon by anyone as a substitute for professional engineering design and documentation required by building code, contract, or applicable law. By accepting these comments you agree they do not constitute any representations, endorsements of, or an assumption by Johns Manville of any liability for either the adequacy of design of this building or any other material not supplied by Johns Manville.

Note: For the most current information on general guidelines, please refer to the System Considerations tab under Commercial Roofing Products on the JM Roofing Web site. For specifications, flashing details and general installation information please refer to the Application Tools tab.

Refer to the Safe Use Instructions and product label prior to using this product.



Membrane Side Lap

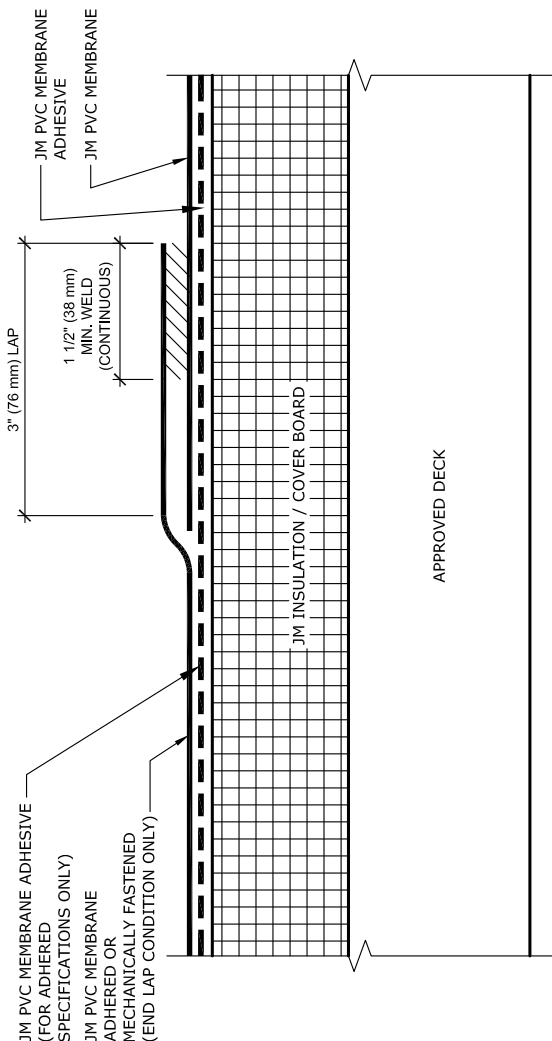

NOTES:

1. REFER TO JOHNS MANVILLE WEBSITE (www.jm.com) FOR MOST UP-TO-DATE INFORMATION.
2. PLEASE SEE SINGLE PLY FLASHING SPECIFICATIONS FOR A FULL DESCRIPTION OF INSTALLATION INSTRUCTIONS AND REQUIREMENTS WHICH ARE CONSIDERED A PART OF THIS DETAIL.
3. ANY CARPENTRY OR METAL WORK SHOULD BE DESIGNED AND CONSTRUCTED IN ACCORDANCE WITH LOCAL CODE REQUIREMENTS AND/OR PROJECT SPECIFICATIONS. THESE COMPONENTS SHOULD BE REVIEWED AND APPROVED BY A LICENSED DESIGN PROFESSIONAL.
4. JM PVC EDGE SEALANT IS OPTIONAL ON ALL CUT OR NON-ENCAPSULATED EDGES OF REINFORCED MEMBRANE. THIS INCLUDES FACTORY CUT MEMBRANE (SEE DETAIL P-MS-01).

Maximum Guarantee Term: 30 Year

Johns Manville is a manufacturer of commercial roofing products and offers this general conceptual information to you as a courtesy. This complimentary assistance is not to be used or relied upon by anyone as a substitute for professional engineering design and documentation required by building code, contract, or applicable law. By accepting these comments you agree they do not constitute any representations, endorsements of, or an assumption by Johns Manville of any liability for either the adequacy of design of this building or any other material not supplied by Johns Manville.

Note: For the most current information on general guidelines, please refer to the System Considerations tab under Commercial Roofing Products on the JM Roofing Web site. For specifications, flashing details and general installation information please refer to the Application Tools tab.

Refer to the Safe Use Instructions and product label prior to using this product.



PVC Fleece Backed Adhesive Applied Membrane Butted End Cap

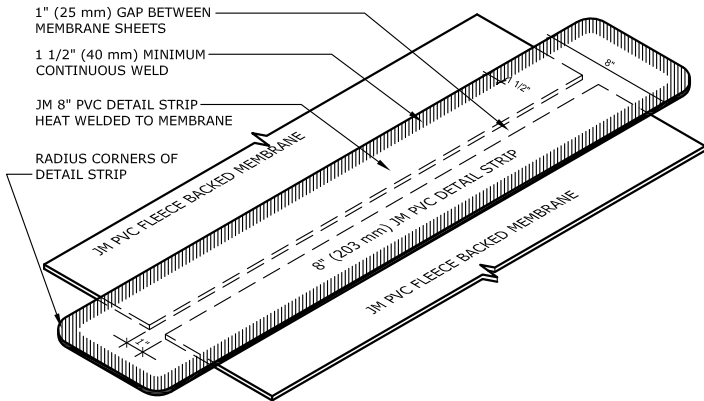

ISOMETRIC VIEW

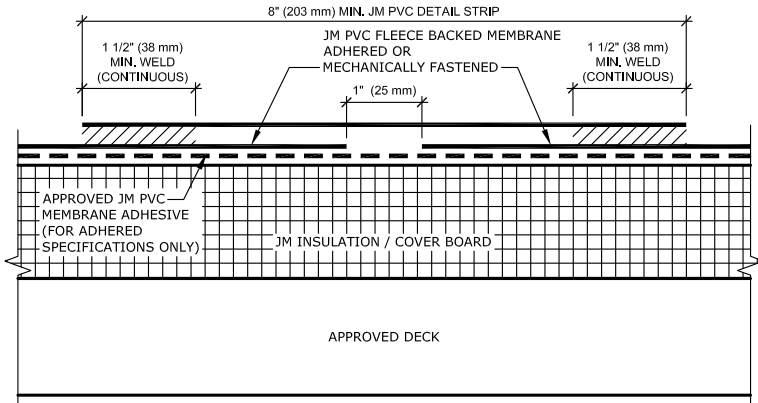

NOTES:

1. REFER TO JOHNS MANVILLE WEBSITE (www.jm.com) FOR MOST UP-TO-DATE INFORMATION.
2. PLEASE SEE SINGLE PLY FLASHING SPECIFICATIONS FOR A FULL DESCRIPTION OF INSTALLATION INSTRUCTIONS AND REQUIREMENTS WHICH ARE CONSIDERED A PART OF THIS DETAIL.
3. ANY CARPENTRY OR METAL WORK SHOULD BE DESIGNED AND CONSTRUCTED IN ACCORDANCE WITH LOCAL CODE REQUIREMENTS AND/OR PROJECT SPECIFICATIONS. THESE COMPONENTS SHOULD BE REVIEWED AND APPROVED BY A LICENSED DESIGN PROFESSIONAL.
4. JM PVC EDGE SEALANT IS OPTIONAL ON ALL CUT OR NON-ENCAPSULATED EDGES OF REINFORCED MEMBRANE. THIS INCLUDES FACTORY CUT MEMBRANE (SEE DETAIL P-MS-01).

Maximum Guarantee Term: 30 Year

Johns Manville is a manufacturer of commercial roofing products and offers this general conceptual information to you as a courtesy. This complimentary assistance is not to be used or relied upon by anyone as a substitute for professional engineering design and documentation required by building code, contract, or applicable law. By accepting these comments you agree they do not constitute any representations, endorsements of, or an assumption by Johns Manville of any liability for either the adequacy of design of this building or any other material not supplied by Johns Manville.

Note: For the most current information on general guidelines, please refer to the System Considerations tab under Commercial Roofing Products on the JM Roofing Web site. For specifications, flashing details and general installation information please refer to the Application Tools tab.

Refer to the Safe Use Instructions and product label prior to using this product.



Slope Transition - Valley

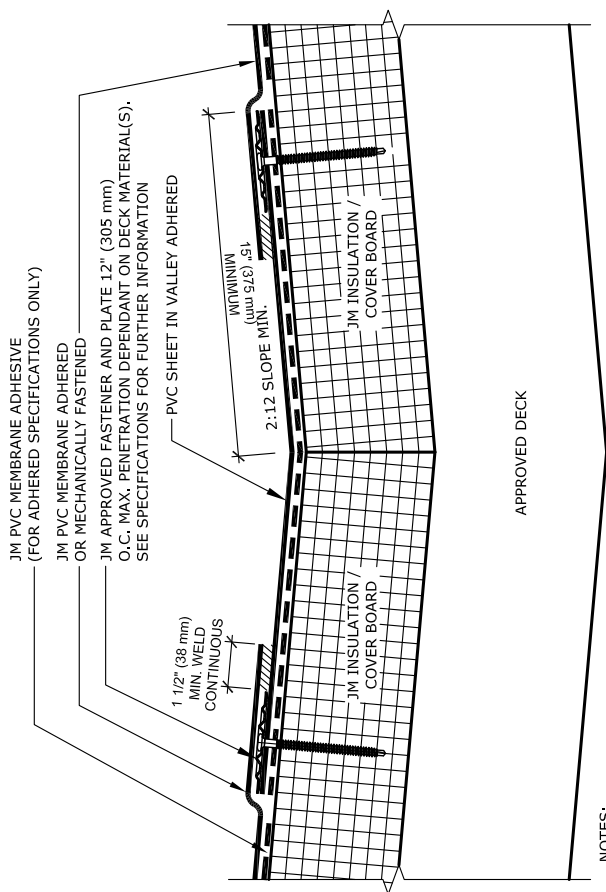

NOTES:

1. REFER TO JOHNS MANVILLE WEBSITE (www.jm.com) FOR MOST UP-TO-DATE INFORMATION.
2. PLEASE SEE SINGLE PLY FLASHING SPECIFICATIONS FOR A FULL DESCRIPTION OF INSTALLATION INSTRUCTIONS AND REQUIREMENTS WHICH ARE CONSIDERED A PART OF THIS DETAIL.
3. ANY CARPENTRY OR METAL WORK SHOULD BE DESIGNED AND CONSTRUCTED IN ACCORDANCE WITH LOCAL CODE REQUIREMENTS AND/OR PROJECT SPECIFICATIONS. THESE COMPONENTS SHOULD BE REVIEWED AND APPROVED BY A LICENSED DESIGN PROFESSIONAL.
4. JM PVC EDGE SEALANT IS OPTIONAL ON ALL CUT OR NON-ENCAPSULATED EDGES OF REINFORCED MEMBRANE. THIS INCLUDES FACTORY CUT MEMBRANE (SEE DETAIL P-MS-01).

Maximum Guarantee Term: 30 Year

Johns Manville is a manufacturer of commercial roofing products and offers this general conceptual information to you as a courtesy. This complimentary assistance is not to be used or relied upon by anyone as a substitute for professional engineering design and documentation required by building code, contract, or applicable law. By accepting these comments you agree they do not constitute any representations, endorsements of, or an assumption by Johns Manville of any liability for either the adequacy of design of this building or any other material not supplied by Johns Manville.

Note: For the most current information on general guidelines, please refer to the System Considerations tab under Commercial Roofing Products on the JM Roofing Web site. For specifications, flashing details and general installation information please refer to the Application Tools tab.

Refer to the Safe Use Instructions and product label prior to using this product.



Slope Transition - Ridge

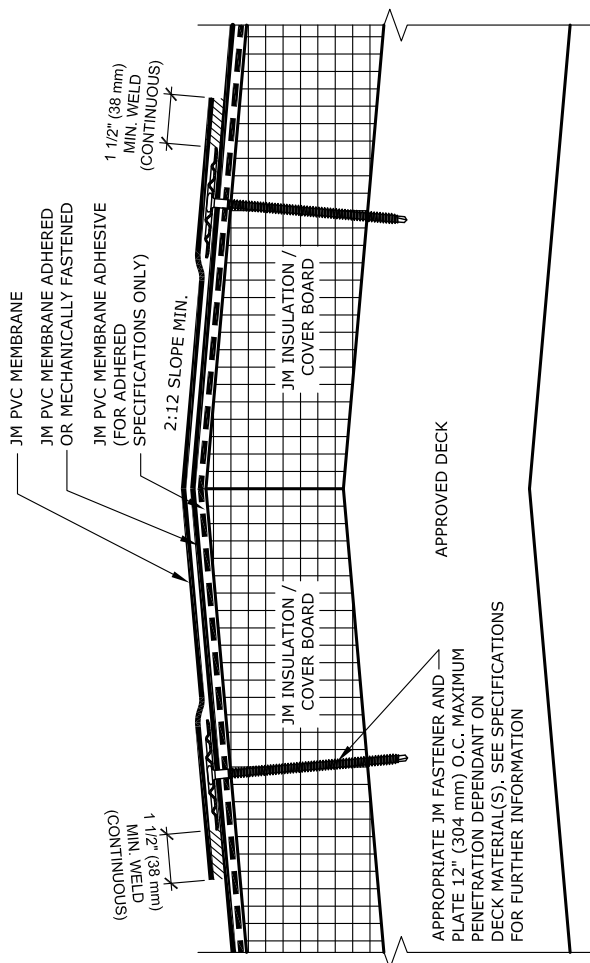

NOTES:

1. REFER TO JOHNS MANVILLE WEBSITE (www.jm.com) FOR MOST UP-TO-DATE INFORMATION.
2. PLEASE SEE SINGLE PLY FLASHING SPECIFICATIONS FOR A FULL DESCRIPTION OF INSTALLATION INSTRUCTIONS AND REQUIREMENTS WHICH ARE CONSIDERED A PART OF THIS DETAIL.
3. ANY CARPENTRY OR METAL WORK SHOULD BE DESIGNED AND CONSTRUCTED IN ACCORDANCE WITH LOCAL CODE REQUIREMENTS AND/OR PROJECT SPECIFICATIONS. THESE COMPONENTS SHOULD BE REVIEWED AND APPROVED BY A LICENSED DESIGN PROFESSIONAL.
4. JM PVC EDGE SEALANT IS OPTIONAL ON ALL CUT OR NON-ENCAPSULATED EDGES OF REINFORCED MEMBRANE. THIS INCLUDES FACTORY CUT MEMBRANE (SEE DETAIL P-MS-01).

Maximum Guarantee Term: 30 Year

Johns Manville is a manufacturer of commercial roofing products and offers this general conceptual information to you as a courtesy. This complimentary assistance is not to be used or relied upon by anyone as a substitute for professional engineering design and documentation required by building code, contract, or applicable law. By accepting these comments you agree they do not constitute any representations, endorsements of, or an assumption by Johns Manville of any liability for either the adequacy of design of this building or any other material not supplied by Johns Manville.

Note: For the most current information on general guidelines, please refer to the System Considerations tab under Commercial Roofing Products on the JM Roofing Web site. For specifications, flashing details and general installation information please refer to the Application Tools tab.

Refer to the Safe Use Instructions and product label prior to using this product.



JM PVC Profile Attachment

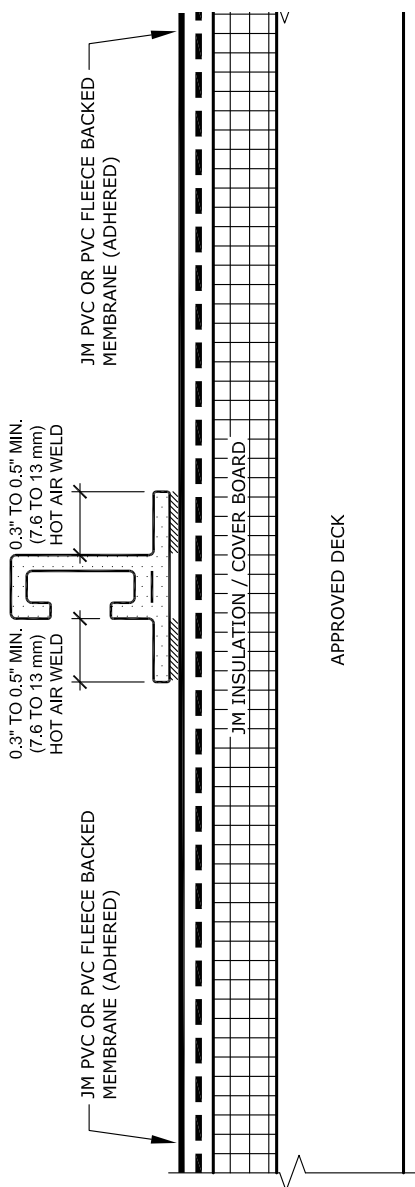

NOTES:

1. REFER TO JOHNS MANVILLE WEBSITE (www.jm.com) FOR MOST UP-TO-DATE INFORMATION.
2. PLEASE SEE SINGLE PLY FLASHING SPECIFICATIONS FOR A FULL DESCRIPTION OF INSTALLATION INSTRUCTIONS AND REQUIREMENTS WHICH ARE CONSIDERED A PART OF THIS DETAIL.
3. ANY CARPENTRY OR METAL WORK SHOULD BE DESIGNED AND CONSTRUCTED IN ACCORDANCE WITH LOCAL CODE REQUIREMENTS AND/OR PROJECT SPECIFICATIONS. THESE COMPONENTS SHOULD BE REVIEWED AND APPROVED BY A LICENSED DESIGN PROFESSIONAL.

Maximum Guarantee Term: 30 Year

Johns Manville is a manufacturer of commercial roofing products and offers this general conceptual information to you as a courtesy. This complimentary assistance is not to be used or relied upon by anyone as a substitute for professional engineering design and documentation required by building code, contract, or applicable law. By accepting these comments you agree they do not constitute any representations, endorsements of, or an assumption by Johns Manville of any liability for either the adequacy of design of this building or any other material not supplied by Johns Manville.

Note: For the most current information on general guidelines, please refer to the System Considerations tab under Commercial Roofing Products on the JM Roofing Web site. For specifications, flashing details and general installation information please refer to the Application Tools tab.

Refer to the Safe Use Instructions and product label prior to using this product.



PVC Standing Seam Profile Lap Joint

NOTES:

1. REFER TO JOHNS MANVILLE WEBSITE (www.jm.com) FOR MOST UP-TO-DATE INFORMATION.
2. PLEASE SEE SINGLE PLY FLASHING SPECIFICATIONS FOR A FULL DESCRIPTION OF INSTALLATION INSTRUCTIONS AND REQUIREMENTS WHICH ARE CONSIDERED A PART OF THIS DETAIL.
3. ANY CARPENTRY OR METAL WORK SHOULD BE DESIGNED AND CONSTRUCTED IN ACCORDANCE WITH LOCAL CODE REQUIREMENTS AND/OR PROJECT SPECIFICATIONS. THESE COMPONENTS SHOULD BE REVIEWED AND APPROVED BY A LICENSED DESIGN PROFESSIONAL.

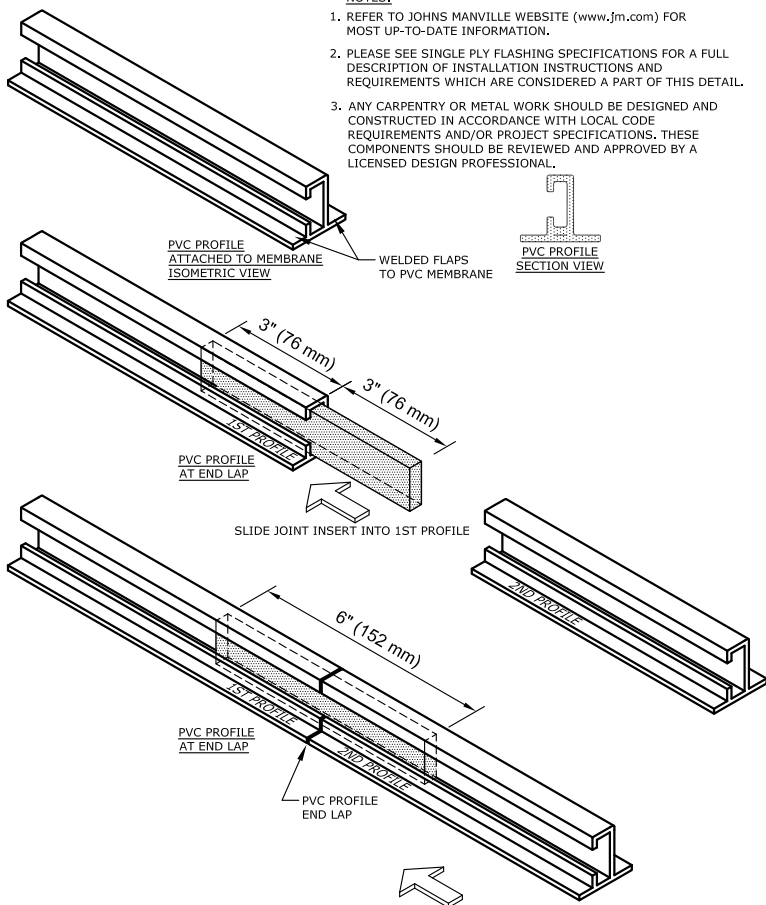

Maximum Guarantee Term: 30 Year

Johns Manville is a manufacturer of commercial roofing products and offers this general conceptual information to you as a courtesy. This complimentary assistance is not to be used or relied upon by anyone as a substitute for professional engineering design and documentation required by building code, contract, or applicable law. By accepting these comments you agree they do not constitute any representations, endorsements of, or an assumption by Johns Manville of any liability for either the adequacy of design of this building or any other material not supplied by Johns Manville.

Note: For the most current information on general guidelines, please refer to the System Considerations tab under Commercial Roofing Products on the JM Roofing Web site. For specifications, flashing details and general installation information please refer to the Application Tools tab.

Refer to the Safe Use Instructions and product label prior to using this product.



JM PVC Profile Spacing on 76" Fleece Backed Sheets

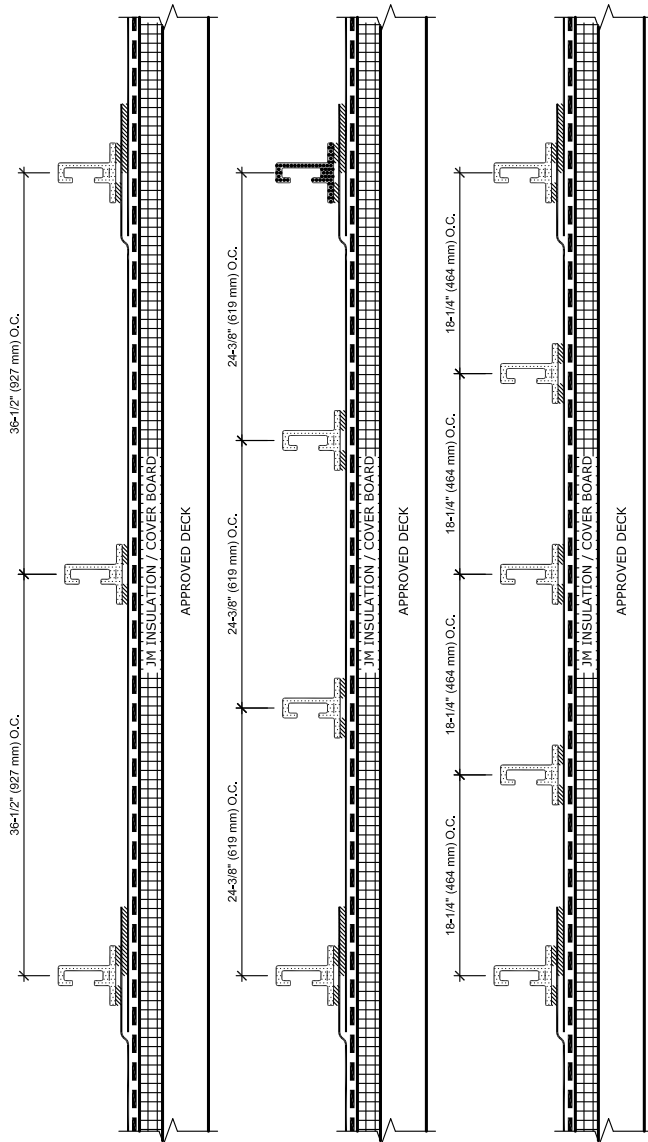

NOTES:

1. REFER TO JOHNS MANVILLE WEBSITE (www.jm.com) FOR MOST UP-TO-DATE INFORMATION.
2. PLEASE SEE SINGLE PLY FLASHING SPECIFICATIONS FOR A FULL DESCRIPTION OF INSTALLATION INSTRUCTIONS AND REQUIREMENTS WHICH ARE CONSIDERED A PART OF THIS DETAIL.
3. ANY CARPENTRY OR METAL WORK SHOULD BE DESIGNED AND CONSTRUCTED IN ACCORDANCE WITH LOCAL CODE REQUIREMENTS AND/OR PROJECT SPECIFICATIONS. THESE COMPONENTS SHOULD BE REVIEWED AND APPROVED BY A LICENSED DESIGN PROFESSIONAL.

Maximum Guarantee Term: 30 Year

Johns Manville is a manufacturer of commercial roofing products and offers this general conceptual information to you as a courtesy. This complimentary assistance is not to be used or relied upon by anyone as a substitute for professional engineering design and documentation required by building code, contract, or applicable law. By accepting these comments you agree they do not constitute any representations, endorsements of, or an assumption by Johns Manville of any liability for either the adequacy of design of this building or any other material not supplied by Johns Manville.

Note: For the most current information on general guidelines, please refer to the System Considerations tab under Commercial Roofing Products on the JM Roofing Web site. For specifications, flashing details and general installation information please refer to the Application Tools tab.

Refer to the Safe Use Instructions and product label prior to using this product.



JM PVC Profile Spacing on 144" Fleece Backed Sheets

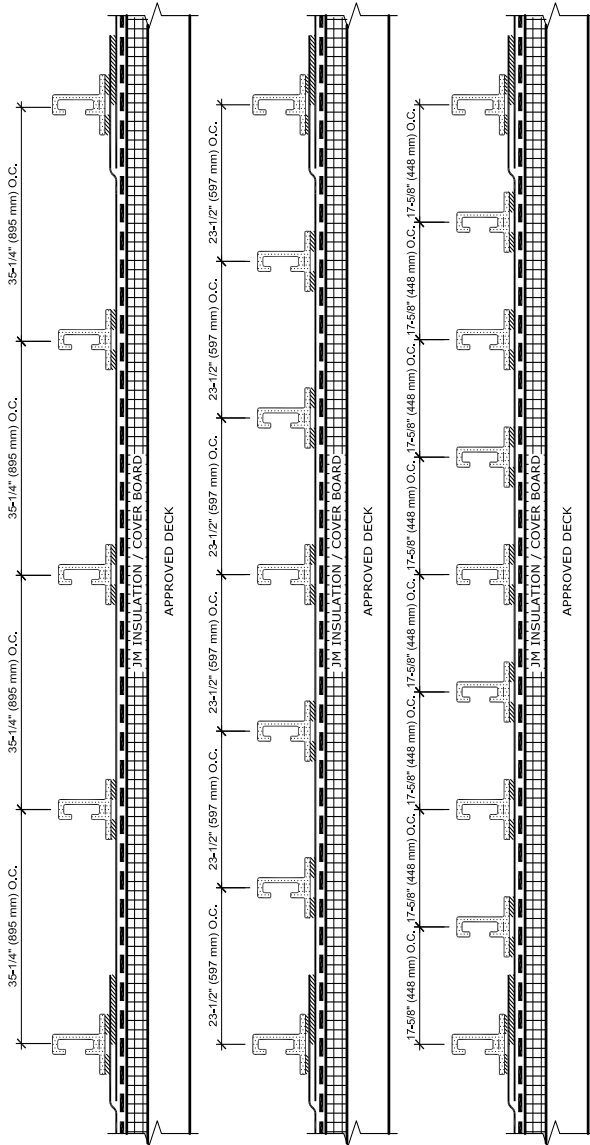

- NOTES:
1. REFER TO JOHNS MANVILLE WEBSITE (www.jm.com) FOR MOST UP-TO-DATE INFORMATION.
 2. PLEASE SEE SINGLE PLY FLASHING SPECIFICATIONS FOR A FULL DESCRIPTION OF INSTALLATION INSTRUCTIONS AND REQUIREMENTS WHICH ARE CONSIDERED A PART OF THIS DETAIL.
 3. ANY CARPENTRY OR METAL WORK SHOULD BE DESIGNED AND CONSTRUCTED IN ACCORDANCE WITH LOCAL CODE REQUIREMENTS AND/OR PROJECT SPECIFICATIONS. THESE COMPONENTS SHOULD BE REVIEWED AND APPROVED BY A LICENSED DESIGN PROFESSIONAL.

Maximum Guarantee Term: 30 Year

Johns Manville is a manufacturer of commercial roofing products and offers this general conceptual information to you as a courtesy. This complimentary assistance is not to be used or relied upon by anyone as a substitute for professional engineering design and documentation required by building code, contract, or applicable law. By accepting these comments you agree they do not constitute any representations, endorsements of, or an assumption by Johns Manville of any liability for either the adequacy of design of this building or any other material not supplied by Johns Manville.

Note: For the most current information on general guidelines, please refer to the System Considerations tab under Commercial Roofing Products on the JM Roofing Web site. For specifications, flashing details and general installation information please refer to the Application Tools tab.

Refer to the Safe Use Instructions and product label prior to using this product.



JM PVC Profile Spacing on 78" PVC Sheets

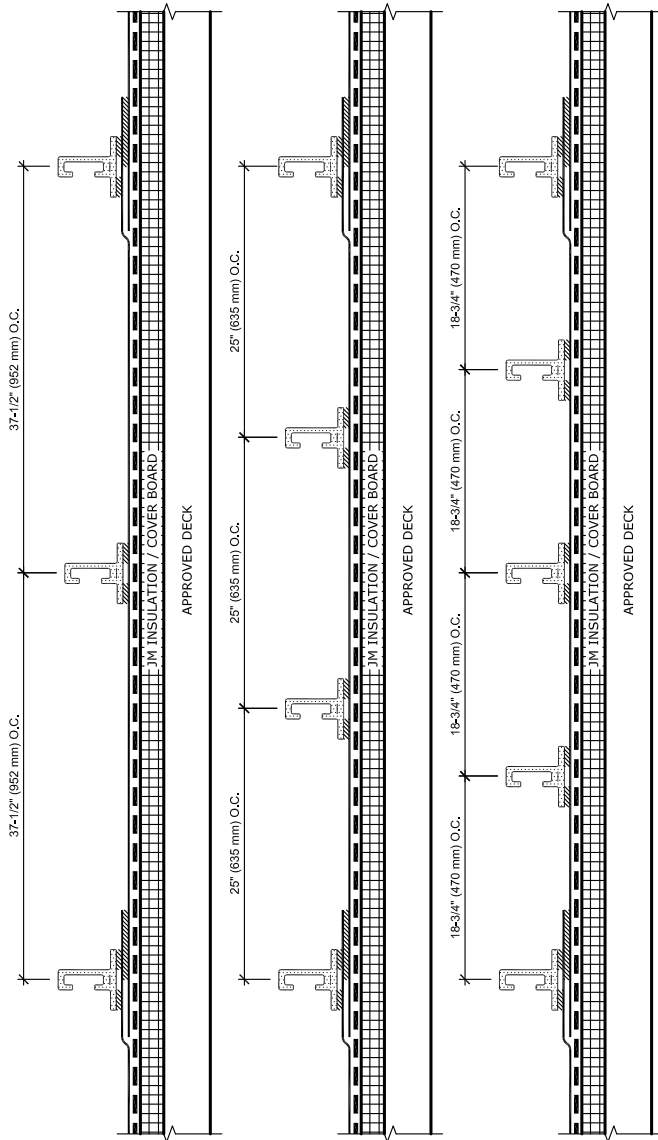

NOTES:

1. REFER TO JOHNS MANVILLE WEBSITE (www.jm.com) FOR MOST UP-TO-DATE INFORMATION.
2. PLEASE SEE SINGLE PLY FLASHING SPECIFICATIONS FOR A FULL DESCRIPTION OF INSTALLATION INSTRUCTIONS AND REQUIREMENTS WHICH ARE CONSIDERED A PART OF THIS DETAIL.
3. ANY CARPENTRY OR METAL WORK SHOULD BE DESIGNED AND CONSTRUCTED IN ACCORDANCE WITH LOCAL CODE REQUIREMENTS AND/OR PROJECT SPECIFICATIONS. THESE COMPONENTS SHOULD BE REVIEWED AND APPROVED BY A LICENSED DESIGN PROFESSIONAL.

Maximum Guarantee Term: 30 Year

Johns Manville is a manufacturer of commercial roofing products and offers this general conceptual information to you as a courtesy. This complimentary assistance is not to be used or relied upon by anyone as a substitute for professional engineering design and documentation required by building code, contract, or applicable law. By accepting these comments you agree they do not constitute any representations, endorsements of, or an assumption by Johns Manville of any liability for either the adequacy of design of this building or any other material not supplied by Johns Manville.

Note: For the most current information on general guidelines, please refer to the System Considerations tab under Commercial Roofing Products on the JM Roofing Web site. For specifications, flashing details and general installation information please refer to the Application Tools tab.

Refer to the Safe Use Instructions and product label prior to using this product.



JM PVC Profile Spacing on 120" PVC Sheets

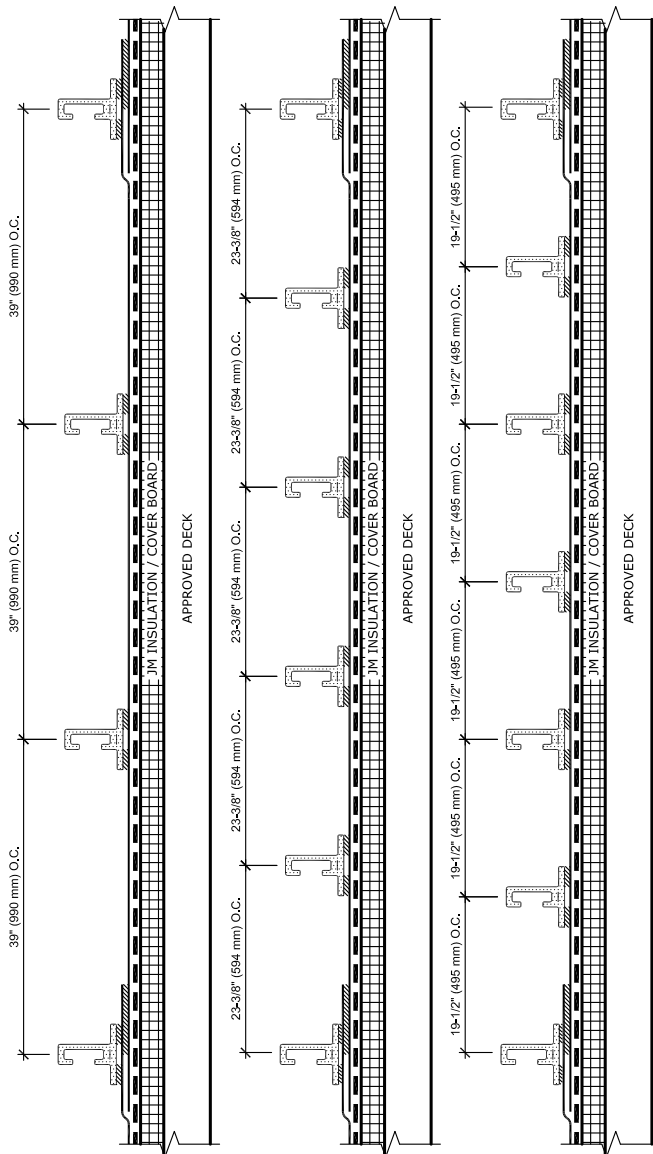

NOTES:

1. REFER TO JOHNS MANVILLE WEBSITE (www.jm.com) FOR MOST UP-TO-DATE INFORMATION.
2. PLEASE SEE SINGLE PLY FLASHING SPECIFICATIONS FOR A FULL DESCRIPTION OF INSTALLATION INSTRUCTIONS AND REQUIREMENTS WHICH ARE CONSIDERED A PART OF THIS DETAIL.
3. ANY CARPENTRY OR METAL WORK SHOULD BE DESIGNED AND CONSTRUCTED IN ACCORDANCE WITH LOCAL CODE REQUIREMENTS AND/OR PROJECT SPECIFICATIONS. THESE COMPONENTS SHOULD BE REVIEWED AND APPROVED BY A LICENSED DESIGN PROFESSIONAL.

Maximum Guarantee Term: 30 Year

Johns Manville is a manufacturer of commercial roofing products and offers this general conceptual information to you as a courtesy. This complimentary assistance is not to be used or relied upon by anyone as a substitute for professional engineering design and documentation required by building code, contract, or applicable law. By accepting these comments you agree they do not constitute any representations, endorsements of, or an assumption by Johns Manville of any liability for either the adequacy of design of this building or any other material not supplied by Johns Manville.

Note: For the most current information on general guidelines, please refer to the System Considerations tab under Commercial Roofing Products on the JM Roofing Web site. For specifications, flashing details and general installation information please refer to the Application Tools tab.

Refer to the Safe Use Instructions and product label prior to using this product.



Prefabricated Metal Curb Base Flashing

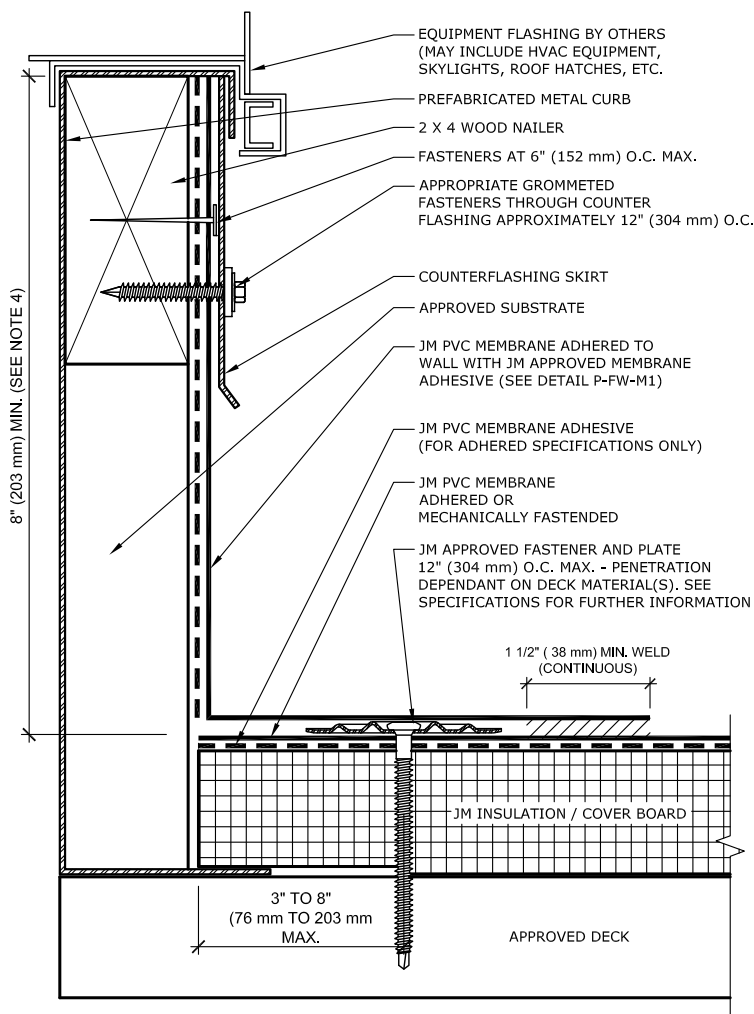

NOTES:

1. REFER TO JOHNS MANVILLE WEBSITE (www.jm.com) FOR MOST UP-TO-DATE INFORMATION.
2. PLEASE SEE SINGLE PLY FLASHING SPECIFICATIONS FOR A FULL DESCRIPTION OF INSTALLATION INSTRUCTIONS AND REQUIREMENTS WHICH ARE CONSIDERED A PART OF THIS DETAIL.
3. ANY CARPENTRY OR METAL WORK SHOULD BE DESIGNED AND CONSTRUCTED IN ACCORDANCE WITH LOCAL CODE REQUIREMENTS AND/OR PROJECT SPECIFICATIONS. THESE COMPONENTS SHOULD BE REVIEWED AND APPROVED BY A LICENSED DESIGN PROFESSIONAL.
4. HEIGHT OF CURB TO BE ADJUSTED WITH NAILERS. IT IS PREFERRED TO RAISE CURB ONTO NAILERS TO EXTEND FLASHING HEIGHT.
5. SEE P-FW-B DETAILS FOR JM APPROVED BASE FLASHING TIE IN TERMINATION METHODS.

Maximum Guarantee Term: 30 Year

Johns Manville is a manufacturer of commercial roofing products and offers this general conceptual information to you as a courtesy. This complimentary assistance is not to be used or relied upon by anyone as a substitute for professional engineering design and documentation required by building code, contract, or applicable law. By accepting these comments you agree they do not constitute any representations, endorsements of, or an assumption by Johns Manville of any liability for either the adequacy of design of this building or any other material not supplied by Johns Manville.

Note: For the most current information on general guidelines, please refer to the System Considerations tab under Commercial Roofing Products on the JM Roofing Web site. For specifications, flashing details and general installation information please refer to the Application Tools tab.

Refer to the Safe Use Instructions and product label prior to using this product.



Roof Hatch

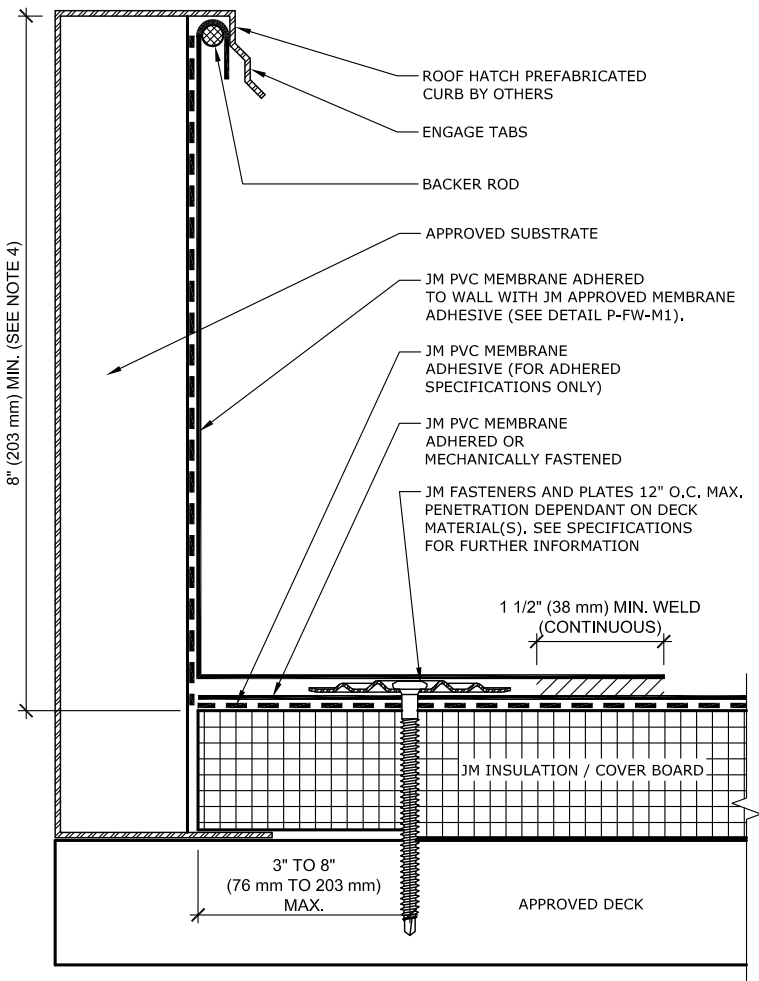

NOTES:

1. REFER TO JOHNS MANVILLE WEBSITE (www.jm.com) FOR MOST UP-TO-DATE INFORMATION.
2. PLEASE SEE SINGLE PLY FLASHING SPECIFICATIONS FOR A FULL DESCRIPTION OF INSTALLATION INSTRUCTIONS AND REQUIREMENTS WHICH ARE CONSIDERED A PART OF THIS DETAIL.
3. ANY CARPENTRY OR METAL WORK SHOULD BE DESIGNED AND CONSTRUCTED IN ACCORDANCE WITH LOCAL CODE REQUIREMENTS AND/OR PROJECT SPECIFICATIONS. THESE COMPONENTS SHOULD BE REVIEWED AND APPROVED BY A LICENSED DESIGN PROFESSIONAL.
4. HEIGHT OF CURB TO BE ADJUSTED WITH NAILERS. IT IS PREFERRED TO RAISE CURB ONTO NAILERS TO EXTEND FLASHING HEIGHT.
5. SEE P-FW-B DETAILS FOR JM APPROVED BASE FLASHING TIE IN TERMINATION METHODS.

Maximum Guarantee Term: 30 Year

Johns Manville is a manufacturer of commercial roofing products and offers this general conceptual information to you as a courtesy. This complimentary assistance is not to be used or relied upon by anyone as a substitute for professional engineering design and documentation required by building code, contract, or applicable law. By accepting these comments you agree they do not constitute any representations, endorsements of, or an assumption by Johns Manville of any liability for either the adequacy of design of this building or any other material not supplied by Johns Manville.

Note: For the most current information on general guidelines, please refer to the System Considerations tab under Commercial Roofing Products on the JM Roofing Web site. For specifications, flashing details and general installation information please refer to the Application Tools tab.

Refer to the Safe Use Instructions and product label prior to using this product.



Outside Corner

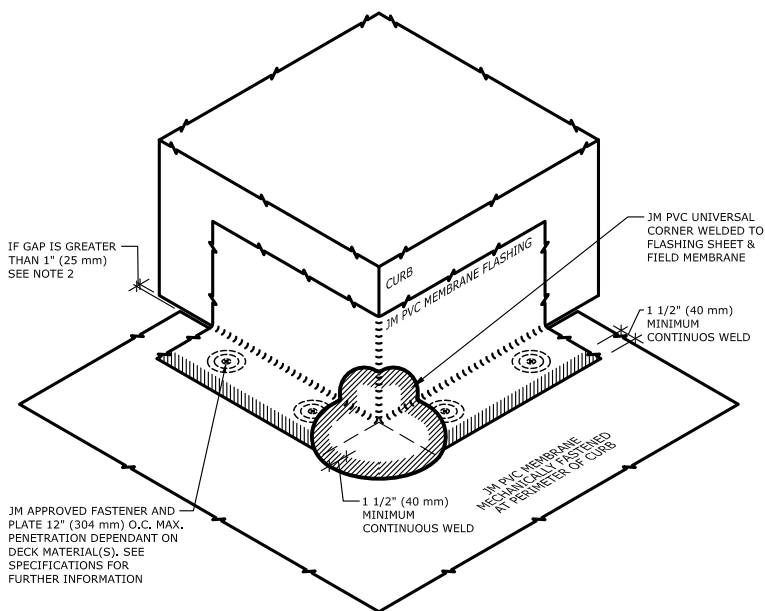

NOTES:

1. REFER TO JOHNS MANVILLE WEBSITE (www.jm.com) FOR MOST UP-TO-DATE INFORMATION.
2. PLEASE SEE SINGLE PLY FLASHING SPECIFICATIONS FOR A FULL DESCRIPTION OF INSTALLATION INSTRUCTIONS AND REQUIREMENTS WHICH ARE CONSIDERED A PART OF THIS DETAIL.
3. ANY CARPENTRY OR METAL WORK SHOULD BE DESIGNED AND CONSTRUCTED IN ACCORDANCE WITH LOCAL CODE REQUIREMENTS AND/OR PROJECT SPECIFICATIONS. THESE COMPONENTS SHOULD BE REVIEWED AND APPROVED BY A LICENSED DESIGN PROFESSIONAL.
4. IF GAP OR CUT IN MEMBRANE IS GREATER THAN 1" UNDER TPO UNIVERSAL CORNER, AN "L" PATCH THAT EXTENDS OUT ONTO THE MEMBRANE A MINIMUM OF 2" MUST BE INSTALLED AT OUTSIDE CORNER. ("L" PATCH SHOWN AT RIGHT WITHOUT TPO UNIVERSAL CORNER)

Maximum Guarantee Term: 30 Year

Johns Manville is a manufacturer of commercial roofing products and offers this general conceptual information to you as a courtesy. This complimentary assistance is not to be used or relied upon by anyone as a substitute for professional engineering design and documentation required by building code, contract, or applicable law. By accepting these comments you agree they do not constitute any representations, endorsements of, or an assumption by Johns Manville of any liability for either the adequacy of design of this building or any other material not supplied by Johns Manville.

Note: For the most current information on general guidelines, please refer to the System Considerations tab under Commercial Roofing Products on the JM Roofing Web site. For specifications, flashing details and general installation information please refer to the Application Tools tab.

Refer to the Safe Use Instructions and product label prior to using this product.



Inside Corner

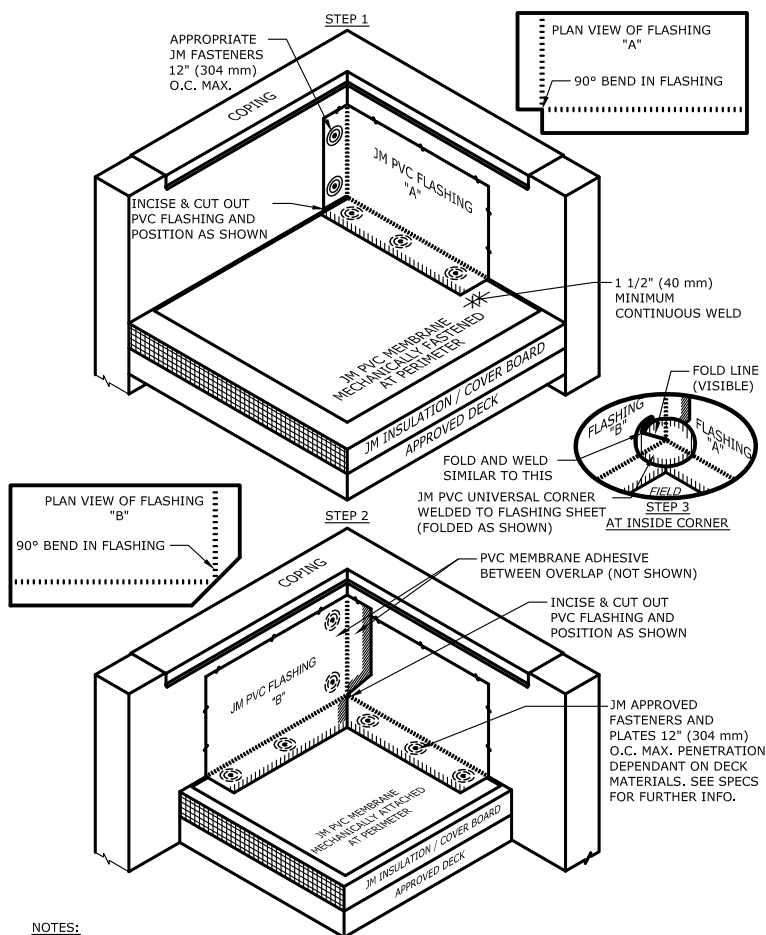

NOTES:

1. REFER TO JOHNS MANVILLE WEBSITE (www.jm.com) FOR MOST UP-TO-DATE INFORMATION.
2. PLEASE SEE SINGLE PLY FLASHING SPECIFICATIONS FOR A FULL DESCRIPTION OF INSTALLATION INSTRUCTIONS AND REQUIREMENTS WHICH ARE CONSIDERED A PART OF THIS DETAIL.
3. ANY CARPENTRY OR METAL WORK SHOULD BE DESIGNED AND CONSTRUCTED IN ACCORDANCE WITH LOCAL CODE REQUIREMENTS AND/OR PROJECT SPECIFICATIONS. THESE COMPONENTS SHOULD BE REVIEWED AND APPROVED BY A LICENSED DESIGN PROFESSIONAL.

Maximum Guarantee Term: 30 Year

Johns Manville is a manufacturer of commercial roofing products and offers this general conceptual information to you as a courtesy. This complimentary assistance is not to be used or relied upon by anyone as a substitute for professional engineering design and documentation required by building code, contract, or applicable law. By accepting these comments you agree they do not constitute any representations, endorsements of, or an assumption by Johns Manville of any liability for either the adequacy of design of this building or any other material not supplied by Johns Manville.

Note: For the most current information on general guidelines, please refer to the System Considerations tab under Commercial Roofing Products on the JM Roofing Web site. For specifications, flashing details and general installation information please refer to the Application Tools tab.

Refer to the Safe Use Instructions and product label prior to using this product.



PVC Wood Curb Base Flashing

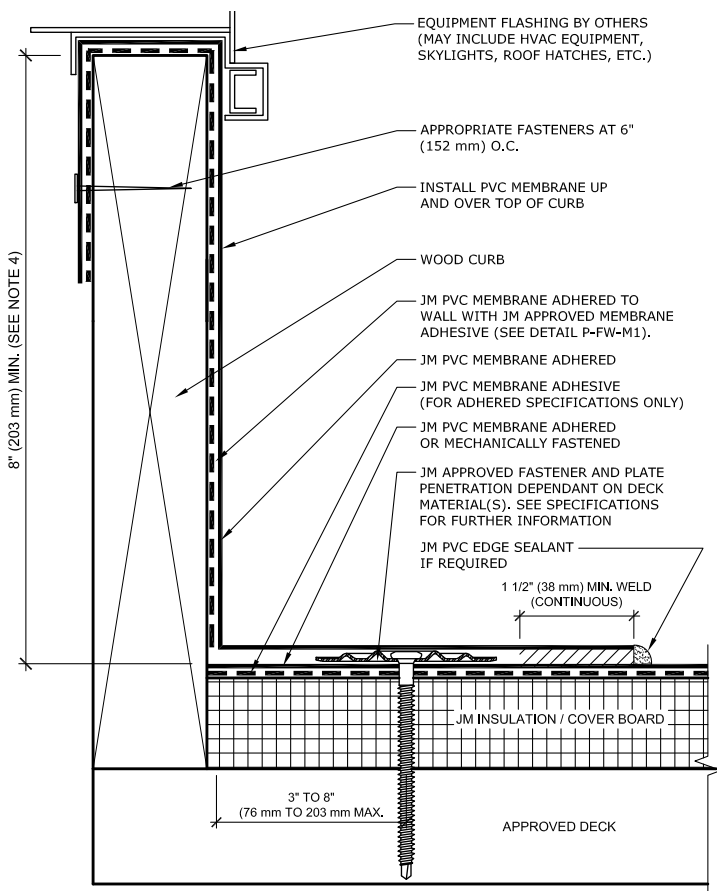

NOTES:

1. REFER TO JOHNS MANVILLE WEBSITE (www.jm.com) FOR MOST UP-TO-DATE INFORMATION.
2. PLEASE SEE SINGLE PLY FLASHING SPECIFICATIONS FOR A FULL DESCRIPTION OF INSTALLATION INSTRUCTIONS AND REQUIREMENTS WHICH ARE CONSIDERED A PART OF THIS DETAIL.
3. ANY CARPENTRY OR METAL WORK SHOULD BE DESIGNED AND CONSTRUCTED IN ACCORDANCE WITH LOCAL CODE REQUIREMENTS AND/OR PROJECT SPECIFICATIONS. THESE COMPONENTS SHOULD BE REVIEWED AND APPROVED BY A LICENSED DESIGN PROFESSIONAL.
4. HEIGHT OF CURB TO BE ADJUSTED WITH NAILERS. IT IS PREFERRED TO RAISE CURB ONTO NAILERS TO EXTEND FLASHING HEIGHT.
5. PVC EDGE SEALANT IS REQUIRED ON ALL CUT AND NON ENCAPSULATED EDGES OF REINFORCED MEMBRANE. THIS INCLUDES FACTORY CUT MEMBRANE (SEE DETAIL P-MS-01).
6. SEE P-FW-B DETAILS FOR JM APPROVED BASE FLASHING TIE IN TERMINATION METHODS.

Maximum Guarantee Term: 30 Year

Johns Manville is a manufacturer of commercial roofing products and offers this general conceptual information to you as a courtesy. This complimentary assistance is not to be used or relied upon by anyone as a substitute for professional engineering design and documentation required by building code, contract, or applicable law. By accepting these comments you agree they do not constitute any representations, endorsements of, or an assumption by Johns Manville of any liability for either the adequacy of design of this building or any other material not supplied by Johns Manville.

Note: For the most current information on general guidelines, please refer to the System Considerations tab under Commercial Roofing Products on the JM Roofing Web site. For specifications, flashing details and general installation information please refer to the Application Tools tab.

Refer to the Safe Use Instructions and product label prior to using this product.



Support - Light

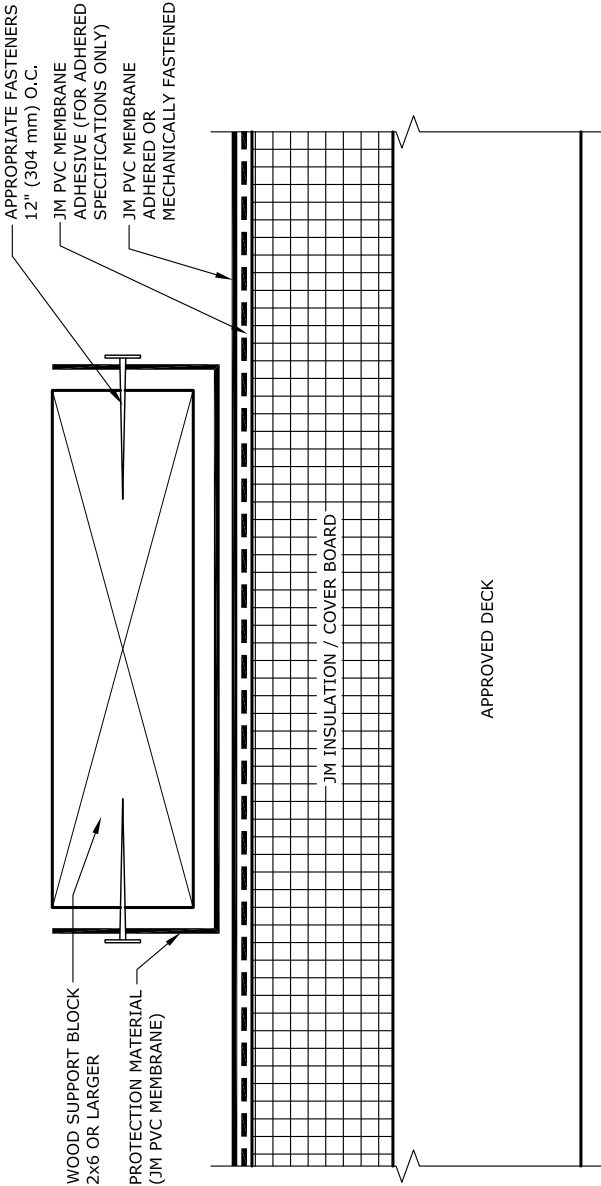

NOTES:

1. REFER TO JOHNS MANVILLE WEBSITE (www.jm.com) FOR MOST UP-TO-DATE INFORMATION.
2. PLEASE SEE SINGLE PLY FLASHING SPECIFICATIONS FOR A FULL DESCRIPTION OF INSTALLATION INSTRUCTIONS AND REQUIREMENTS WHICH ARE CONSIDERED A PART OF THIS DETAIL.
3. ANY CARPENTRY OR METAL WORK SHOULD BE DESIGNED AND CONSTRUCTED IN ACCORDANCE WITH LOCAL CODE REQUIREMENTS AND/OR PROJECT SPECIFICATIONS. THESE COMPONENTS SHOULD BE REVIEWED AND APPROVED BY A LICENSED DESIGN PROFESSIONAL.

Maximum Guarantee Term: 20 Year

Johns Manville is a manufacturer of commercial roofing products and offers this general conceptual information to you as a courtesy. This complimentary assistance is not to be used or relied upon by anyone as a substitute for professional engineering design and documentation required by building code, contract, or applicable law. By accepting these comments you agree they do not constitute any representations, endorsements of, or an assumption by Johns Manville of any liability for either the adequacy of design of this building or any other material not supplied by Johns Manville.

Note: For the most current information on general guidelines, please refer to the System Considerations tab under Commercial Roofing Products on the JM Roofing Web site. For specifications, flashing details and general installation information please refer to the Application Tools tab.

Refer to the Safe Use Instructions and product label prior to using this product.



Support - Medium

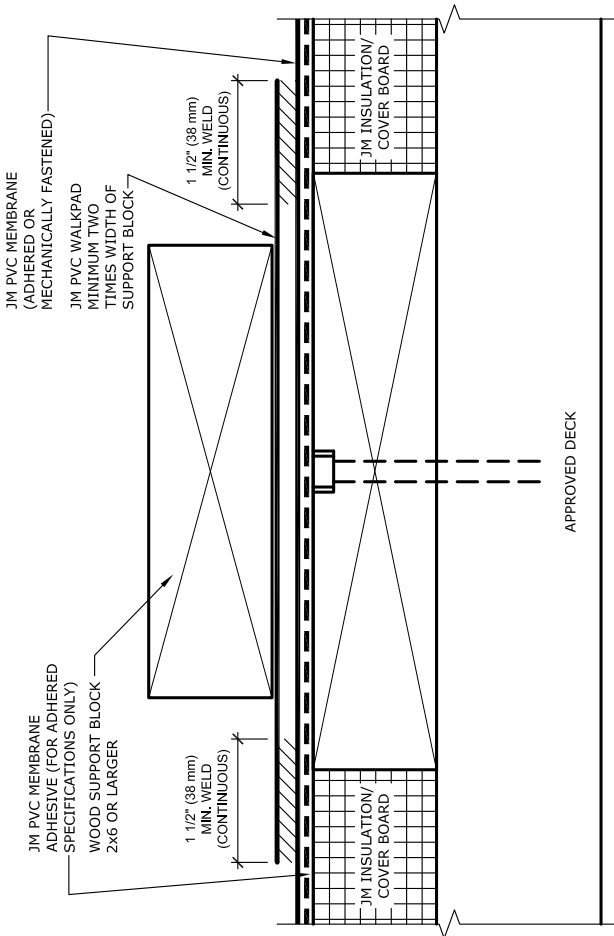

NOTES:

1. REFER TO JOHNS MANVILLE WEBSITE (www.jm.com) FOR MOST UP-TO-DATE INFORMATION.
2. PLEASE SEE SINGLE PLY FLASHING SPECIFICATIONS FOR A FULL DESCRIPTION OF INSTALLATION INSTRUCTIONS AND REQUIREMENTS WHICH ARE CONSIDERED A PART OF THIS DETAIL.
3. ANY CARPENTRY OR METAL WORK SHOULD BE DESIGNED AND CONSTRUCTED IN ACCORDANCE WITH LOCAL CODE REQUIREMENTS AND/OR PROJECT SPECIFICATIONS. THESE COMPONENTS SHOULD BE REVIEWED AND APPROVED BY A LICENSED DESIGN PROFESSIONAL.

Maximum Guarantee Term: 20 Year

Johns Manville is a manufacturer of commercial roofing products and offers this general conceptual information to you as a courtesy. This complimentary assistance is not to be used or relied upon by anyone as a substitute for professional engineering design and documentation required by building code, contract, or applicable law. By accepting these comments you agree they do not constitute any representations, endorsements of, or an assumption by Johns Manville of any liability for either the adequacy of design of this building or any other material not supplied by Johns Manville.

Note: For the most current information on general guidelines, please refer to the System Considerations tab under Commercial Roofing Products on the JM Roofing Web site. For specifications, flashing details and general installation information please refer to the Application Tools tab.

Refer to the Safe Use Instructions and product label prior to using this product.



Support - Heavy

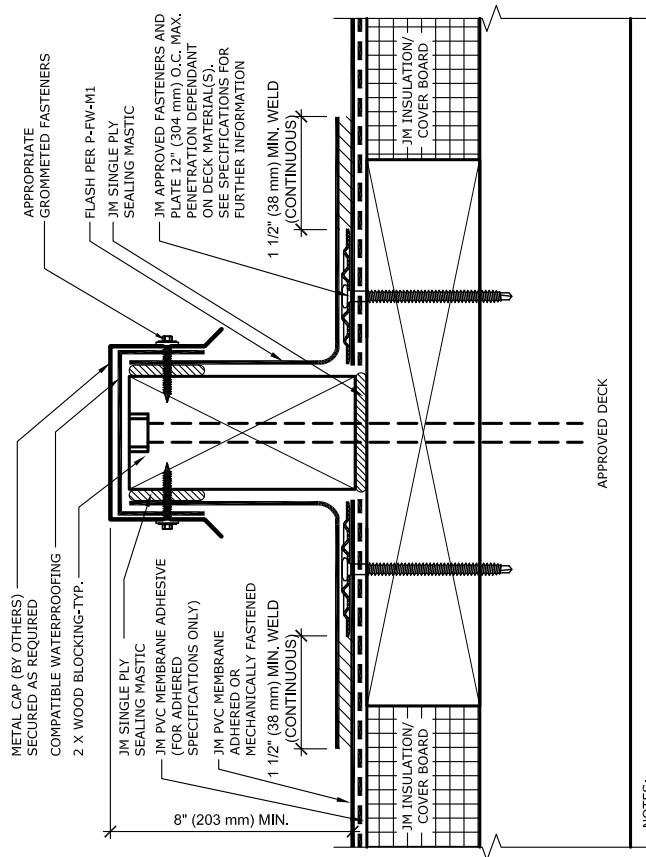

Maximum Guarantee Term: 20 Year

Johns Manville is a manufacturer of commercial roofing products and offers this general conceptual information to you as a courtesy. This complimentary assistance is not to be used or relied upon by anyone as a substitute for professional engineering design and documentation required by building code, contract, or applicable law. By accepting these comments you agree they do not constitute any representations, endorsements of, or an assumption by Johns Manville of any liability for either the adequacy of design of this building or any other material not supplied by Johns Manville.

Note: For the most current information on general guidelines, please refer to the System Considerations tab under Commercial Roofing Products on the JM Roofing Web site. For specifications, flashing details and general installation information please refer to the Application Tools tab.

Refer to the Safe Use Instructions and product label prior to using this product.



Walkway - Concrete Paver

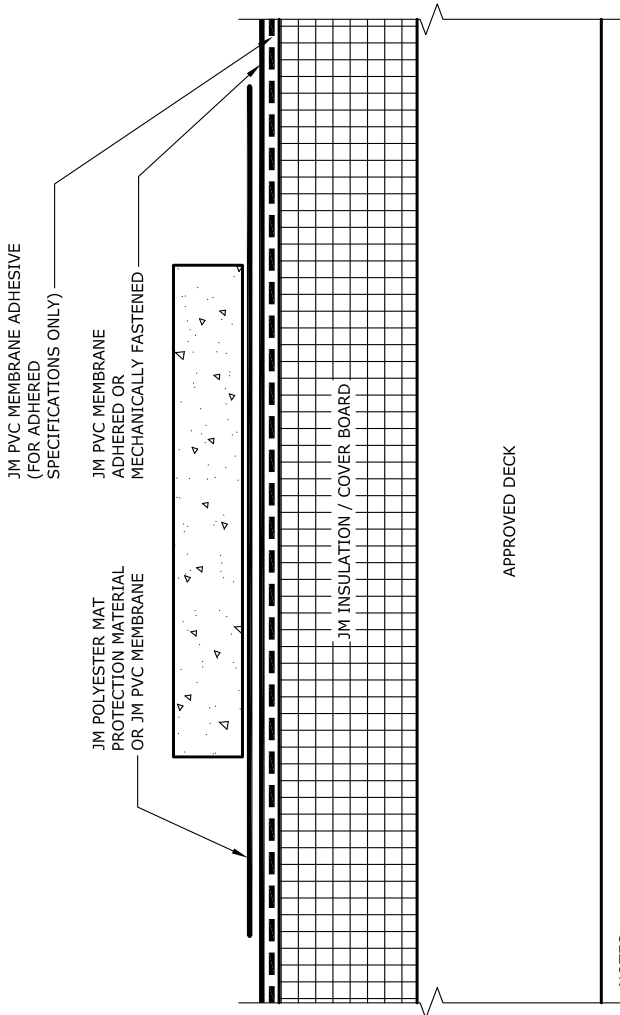

NOTES:

1. REFER TO JOHNS MANVILLE WEBSITE (www.jm.com) FOR MOST UP-TO-DATE INFORMATION.
2. PLEASE SEE SINGLE PLY FLASHING SPECIFICATIONS FOR A FULL DESCRIPTION OF INSTALLATION INSTRUCTIONS AND REQUIREMENTS WHICH ARE CONSIDERED A PART OF THIS DETAIL.
3. ANY CARPENTRY OR METAL WORK SHOULD BE DESIGNED AND CONSTRUCTED IN ACCORDANCE WITH LOCAL CODE REQUIREMENTS AND/OR PROJECT SPECIFICATIONS. THESE COMPONENTS SHOULD BE REVIEWED AND APPROVED BY A LICENSED DESIGN PROFESSIONAL.

Maximum Guarantee Term: 20 Year

Johns Manville is a manufacturer of commercial roofing products and offers this general conceptual information to you as a courtesy. This complimentary assistance is not to be used or relied upon by anyone as a substitute for professional engineering design and documentation required by building code, contract, or applicable law. By accepting these comments you agree they do not constitute any representations, endorsements of, or an assumption by Johns Manville of any liability for either the adequacy of design of this building or any other material not supplied by Johns Manville.

Note: For the most current information on general guidelines, please refer to the System Considerations tab under Commercial Roofing Products on the JM Roofing Web site. For specifications, flashing details and general installation information please refer to the Application Tools tab.

Refer to the Safe Use Instructions and product label prior to using this product.



PVC Walkpads Over Adhered PVC Membrane

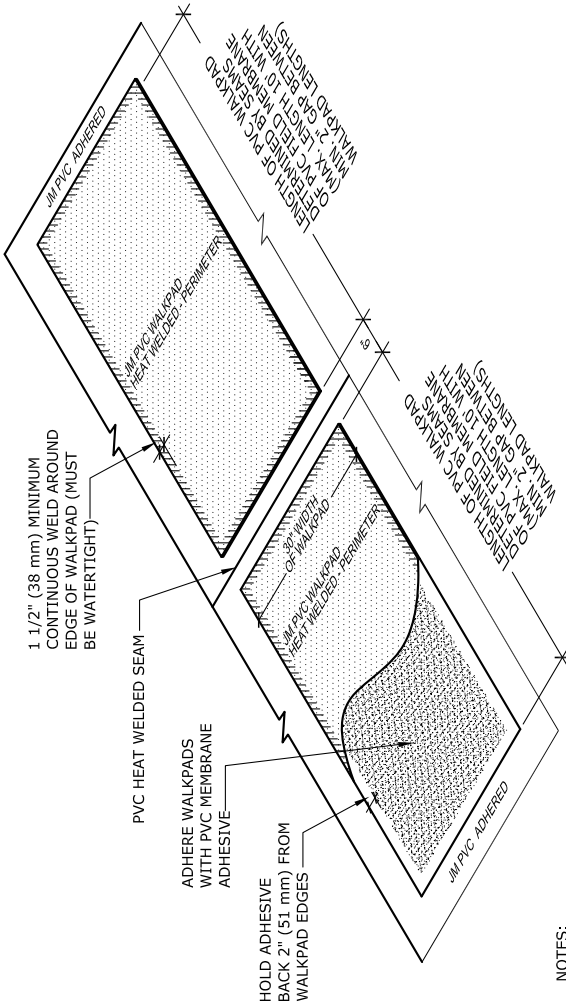

NOTES:

1. REFER TO JOHNS MANVILLE WEBSITE (www.jm.com) FOR MOST UP-TO-DATE INFORMATION.
2. PLEASE SEE SINGLE PLY FLASHING SPECIFICATIONS FOR A FULL DESCRIPTION OF INSTALLATION INSTRUCTIONS AND REQUIREMENTS WHICH ARE CONSIDERED A PART OF THIS DETAIL.
3. ANY CARPENTRY OR METAL WORK SHOULD BE DESIGNED AND CONSTRUCTED IN ACCORDANCE WITH LOCAL CODE REQUIREMENTS AND/OR PROJECT SPECIFICATIONS. THESE COMPONENTS SHOULD BE REVIEWED AND APPROVED BY A LICENSED DESIGN PROFESSIONAL.
4. CLEAN MEMBRANE SURFACE PRIOR TO WALKPAD INSTALLATION WITH JM SINGLE PLY MEMBRANE CLEANER.
5. DO NOT INSTALL WALKPADS OVER MEMBRANE SEAMS.

Maximum Guarantee Term: 20 Year

Johns Manville is a manufacturer of commercial roofing products and offers this general conceptual information to you as a courtesy. This complimentary assistance is not to be used or relied upon by anyone as a substitute for professional engineering design and documentation required by building code, contract, or applicable law. By accepting these comments you agree they do not constitute any representations, endorsements of, or an assumption by Johns Manville of any liability for either the adequacy of design of this building or any other material not supplied by Johns Manville.

Note: For the most current information on general guidelines, please refer to the System Considerations tab under Commercial Roofing Products on the JM Roofing Web site. For specifications, flashing details and general installation information please refer to the Application Tools tab.

Refer to the Safe Use Instructions and product label prior to using this product.



PVC Walkpad Fleece Backed System Adhered

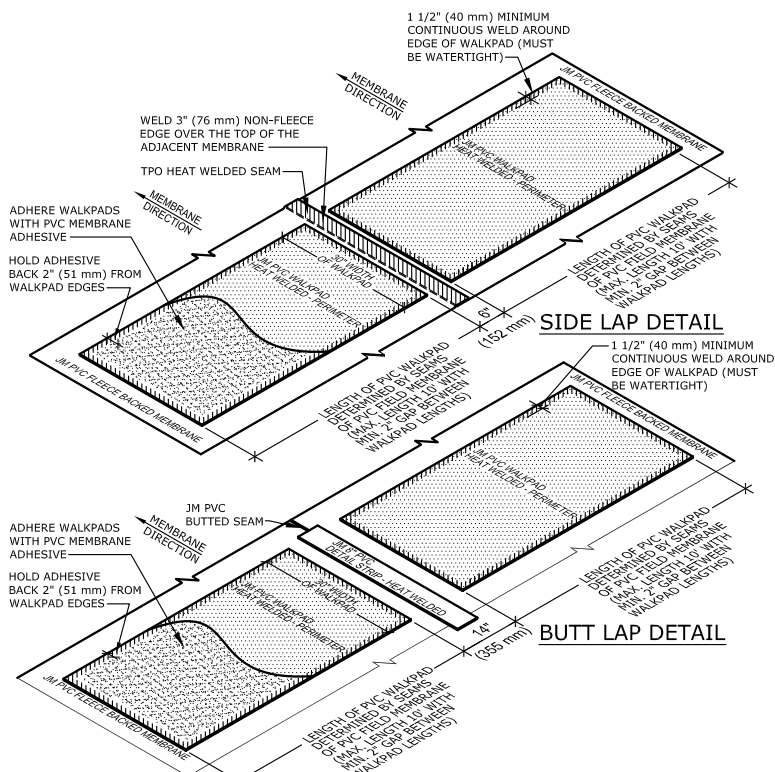

NOTES:

1. REFER TO JOHNS MANVILLE WEBSITE (www.jm.com) FOR MOST UP-TO-DATE INFORMATION.
2. PLEASE SEE SINGLE PLY FLASHING SPECIFICATIONS FOR A FULL DESCRIPTION OF INSTALLATION INSTRUCTIONS AND REQUIREMENTS WHICH ARE CONSIDERED A PART OF THIS DETAIL.
3. ANY CARPENTRY OR METAL WORK SHOULD BE DESIGNED AND CONSTRUCTED IN ACCORDANCE WITH LOCAL CODE REQUIREMENTS AND/OR PROJECT SPECIFICATIONS, THESE COMPONENTS SHOULD BE REVIEWED AND APPROVED BY A LICENSED DESIGN PROFESSIONAL.
4. CLEAN MEMBRANE SURFACE PRIOR TO WALKPAD INSTALLATION WITH JM SINGLE PLY MEMBRANE CLEANER.
5. DO NOT INSTALL WALKPADS OVER MEMBRANE SEAMS.

Maximum Guarantee Term: 20 Year

Johns Manville is a manufacturer of commercial roofing products and offers this general conceptual information to you as a courtesy. This complimentary assistance is not to be used or relied upon by anyone as a substitute for professional engineering design and documentation required by building code, contract, or applicable law. By accepting these comments you agree they do not constitute any representations, endorsements of, or an assumption by Johns Manville of any liability for either the adequacy of design of this building or any other material not supplied by Johns Manville.

Note: For the most current information on general guidelines, please refer to the System Considerations tab under Commercial Roofing Products on the JM Roofing Web site. For specifications, flashing details and general installation information please refer to the Application Tools tab.

Refer to the Safe Use Instructions and product label prior to using this product.



PVC Walkpad Over Mechanically Fastened PVC Membrane

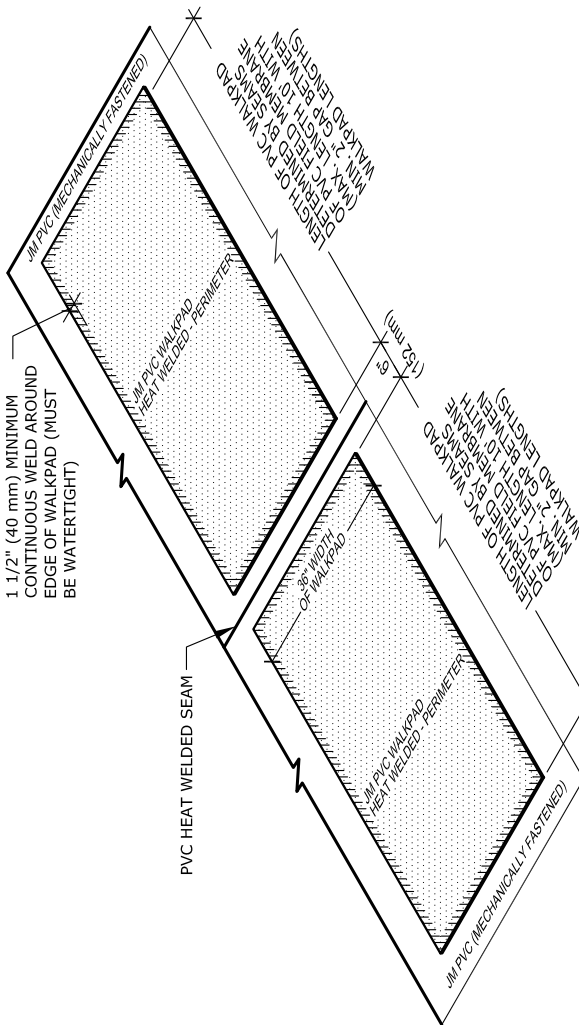

NOTES:

1. REFER TO JOHNS MANVILLE WEBSITE (www.jm.com) FOR MOST UP-TO-DATE INFORMATION.
2. PLEASE SEE SINGLE PLY FLASHING SPECIFICATIONS FOR A FULL DESCRIPTION OF INSTALLATION INSTRUCTIONS AND REQUIREMENTS WHICH ARE CONSIDERED A PART OF THIS DETAIL.
3. ANY CARPENTRY OR METAL WORK SHOULD BE DESIGNED AND CONSTRUCTED IN ACCORDANCE WITH LOCAL CODE REQUIREMENTS AND/OR PROJECT SPECIFICATIONS. THESE COMPONENTS SHOULD BE REVIEWED AND APPROVED BY A LICENSED DESIGN PROFESSIONAL.
4. CLEAN MEMBRANE SURFACE PRIOR TO WALKPAD INSTALLATION WITH JM SINGLE PLY MEMBRANE CLEANER.
5. DO NOT INSTALL WALKPADS OVER MEMBRANE SEAMS.

Maximum Guarantee Term: 20 Year

Johns Manville is a manufacturer of commercial roofing products and offers this general conceptual information to you as a courtesy. This complimentary assistance is not to be used or relied upon by anyone as a substitute for professional engineering design and documentation required by building code, contract, or applicable law. By accepting these comments you agree they do not constitute any representations, endorsements of, or an assumption by Johns Manville of any liability for either the adequacy of design of this building or any other material not supplied by Johns Manville.

Note: For the most current information on general guidelines, please refer to the System Considerations tab under Commercial Roofing Products on the JM Roofing Web site. For specifications, flashing details and general installation information please refer to the Application Tools tab.

Refer to the Safe Use Instructions and product label prior to using this product.



Lightning Rod - Wall Mount

JM DOES NOT EVALUATE OR RECOMMEND ANY LIGHTNING PROTECTION MANUFACTURERS PRODUCTS. THE LIGHTNING PROTECTION DEVICES SHOWN ARE FOR GRAPHIC REPRESENTATION ONLY.

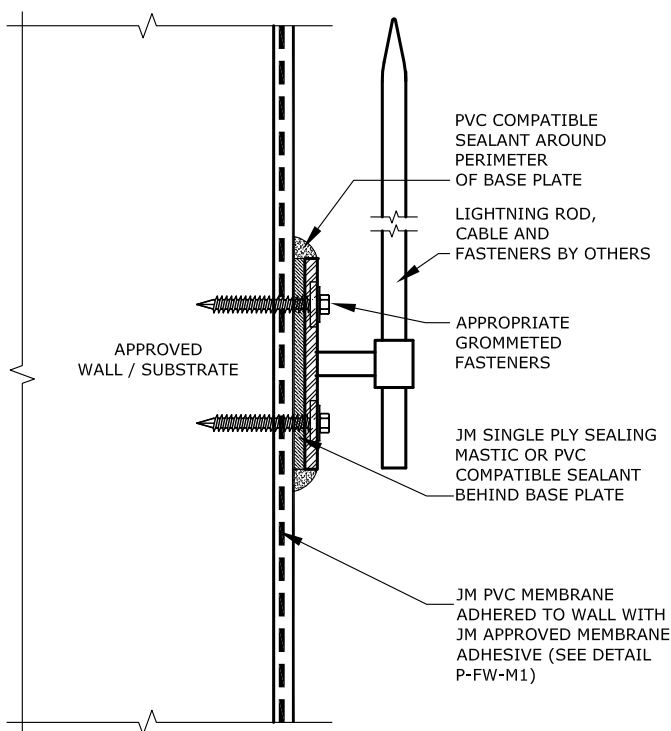

NOTES:

1. REFER TO JOHNS MANVILLE WEBSITE (www.jm.com) FOR MOST UP-TO-DATE INFORMATION.
2. PLEASE SEE SINGLE PLY FLASHING SPECIFICATIONS FOR A FULL DESCRIPTION OF INSTALLATION INSTRUCTIONS AND REQUIREMENTS WHICH ARE CONSIDERED A PART OF THIS DETAIL.
3. ANY CARPENTRY OR METAL WORK SHOULD BE DESIGNED AND CONSTRUCTED IN ACCORDANCE WITH LOCAL CODE REQUIREMENTS AND/OR PROJECT SPECIFICATIONS. THESE COMPONENTS SHOULD BE REVIEWED AND APPROVED BY A LICENSED DESIGN PROFESSIONAL. JM ASSUMES NO RESPONSIBILITY FOR THE INSTALLATION OF LIGHTNING RODS AND ASSOCIATED COMPONENTS OR FOR DAMAGE TO THE ROOF SYSTEM DUE TO FAULTY INSTALLATION OR DETACHMENT FROM SAID SYSTEM.
4. LIGHTNING ROD GROUND WIRE MUST NOT COME IN CONTACT WITH THE ROOFING MEMBRANE.

Johns Manville is a manufacturer of commercial roofing products and offers this general conceptual information to you as a courtesy. This complimentary assistance is not to be used or relied upon by anyone as a substitute for professional engineering design and documentation required by building code, contract, or applicable law. By accepting these comments you agree they do not constitute any representations, endorsements of, or an assumption by Johns Manville of any liability for either the adequacy of design of this building or any other material not supplied by Johns Manville.

Note: For the most current information on general guidelines, please refer to the System Considerations tab under Commercial Roofing Products on the JM Roofing Web site. For specifications, flashing details and general installation information please refer to the Application Tools tab.

Refer to the Safe Use Instructions and product label prior to using this product.



Lightning Rod - Roof Mount

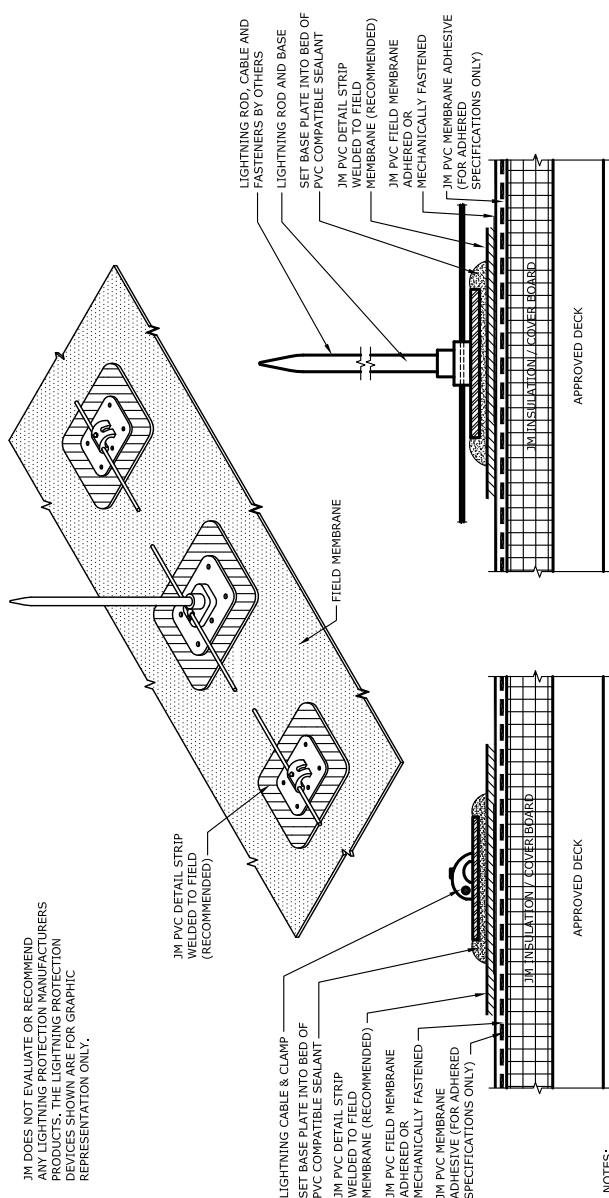

NOTES:

1. REFER TO JOHNS MANVILLE WEBSITE (www.jm.com) FOR MOST UP-TO-DATE INFORMATION.
2. PLEASE SEE SINGLE PLY FLASHING SPECIFICATIONS FOR A FULL DESCRIPTION OF INSTALLATION INSTRUCTIONS AND REQUIREMENTS WHICH ARE CONSIDERED A PART OF THIS DETAIL.
3. ANY CARPENTRY OR METAL WORK SHOULD BE DESIGNED AND CONSTRUCTED IN ACCORDANCE WITH LOCAL CODE REQUIREMENTS AND/OR PROJECT SPECIFICATIONS. THESE COMPONENTS SHOULD BE REVIEWED AND APPROVED BY A LICENSED DESIGN PROFESSIONAL. JM ASSUMES NO RESPONSIBILITY FOR THE INSTALLATION OF LIGHTNING RODS AND ASSOCIATED COMPONENTS OR FOR DAMAGE TO THE ROOF SYSTEM DUE TO FAULTY INSTALLATION OR DETACHMENT FROM SAID SYSTEM.
4. LIGHTNING ROD GROUND WIRE MUST NOT COME IN CONTACT WITH THE ROOFING MEMBRANE. A SACRIFICIAL LAYER OF MEMBRANE IS RECOMMENDED UNDER THE ENTIRE LENGTH OF GROUND WIRE(S).
5. ALL SEALANTS / CAULKING SHALL BE PERIODICALLY INSPECTED AND MAINTAINED BY THE BUILDING OWNER THROUGHOUT THE LIFE OF THE ROOF.

Johns Manville is a manufacturer of commercial roofing products and offers this general conceptual information to you as a courtesy. This complimentary assistance is not to be used or relied upon by anyone as a substitute for professional engineering design and documentation required by building code, contract, or applicable law. By accepting these comments you agree they do not constitute any representations, endorsements of, or an assumption by Johns Manville of any liability for either the adequacy of design of this building or any other material not supplied by Johns Manville.

Note: For the most current information on general guidelines, please refer to the System Considerations tab under Commercial Roofing Products on the JM Roofing Web site. For specifications, flashing details and general installation information please refer to the Application Tools tab.

Refer to the Safe Use Instructions and product label prior to using this product.



Grease Trap

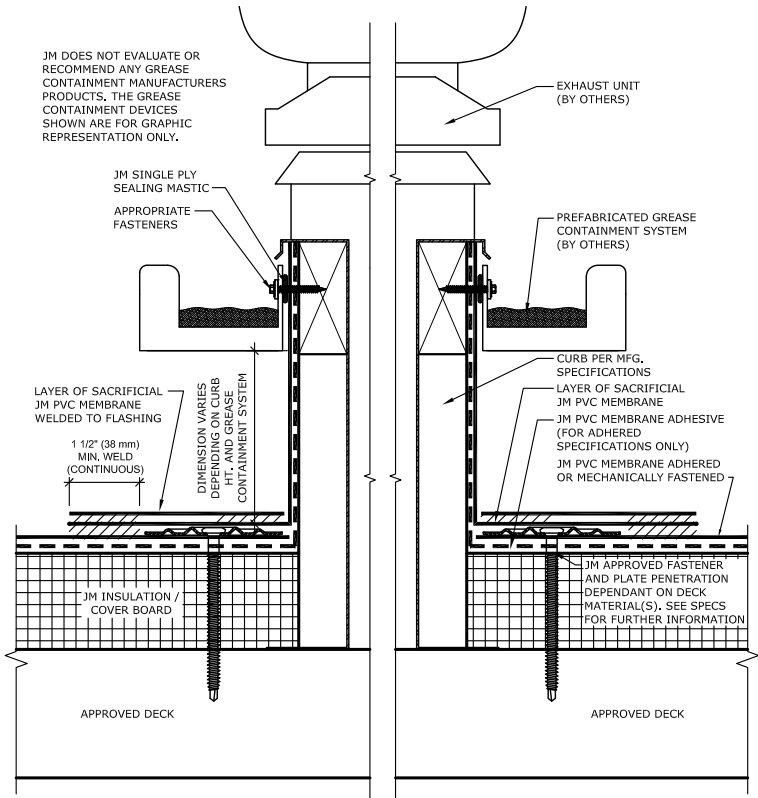

NOTES:

1. REFER TO JOHNS MANVILLE WEBSITE (www.jm.com) FOR MOST UP-TO-DATE INFORMATION.
2. PLEASE SEE SINGLE PLY FLASHING SPECIFICATIONS FOR A FULL DESCRIPTION OF INSTALLATION INSTRUCTIONS AND REQUIREMENTS WHICH ARE CONSIDERED A PART OF THIS DETAIL.
3. ANY CARPENTRY OR METAL WORK SHOULD BE DESIGNED AND CONSTRUCTED IN ACCORDANCE WITH LOCAL CODE REQUIREMENTS AND/OR PROJECT SPECIFICATIONS, THESE COMPONENTS SHOULD BE REVIEWED AND APPROVED BY A LICENSED DESIGN PROFESSIONAL.
4. ANY DAMAGE TO THE ROOF SYSTEM THAT RESULTS FROM IMPROPER MAINTENANCE OR IMPROPER SIZING OF TRAP IS NOT GUARANTEEABLE.

Maximum Guarantee Term: 20 Year

Johns Manville is a manufacturer of commercial roofing products and offers this general conceptual information to you as a courtesy. This complimentary assistance is not to be used or relied upon by anyone as a substitute for professional engineering design and documentation required by building code, contract, or applicable law. By accepting these comments you agree they do not constitute any representations, endorsements of, or an assumption by Johns Manville of any liability for either the adequacy of design of this building or any other material not supplied by Johns Manville.

Note: For the most current information on general guidelines, please refer to the System Considerations tab under Commercial Roofing Products on the JM Roofing Web site. For specifications, flashing details and general installation information please refer to the Application Tools tab.

Refer to the Safe Use Instructions and product label prior to using this product.



JM ENRGY Anchor - PVC

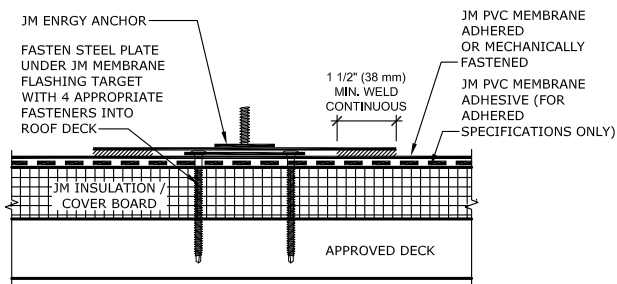
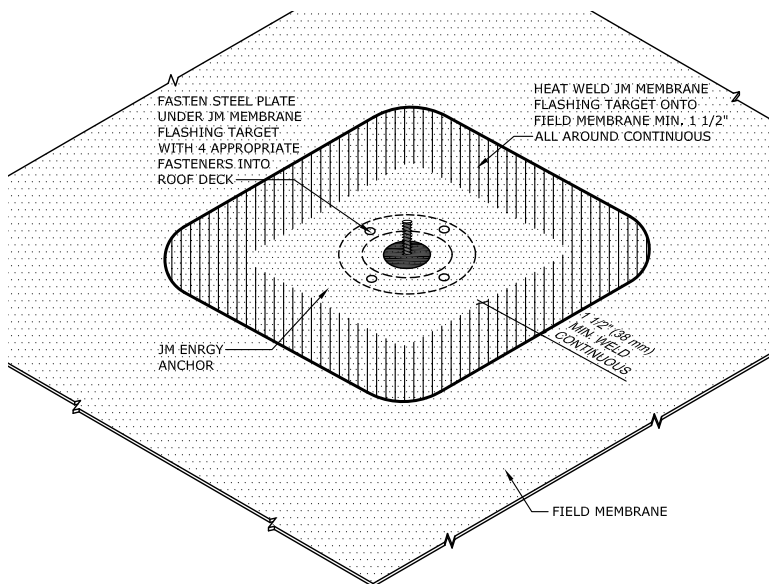

NOTES:

1. REFER TO JOHNS MANVILLE WEBSITE (www.jm.com) FOR MOST UP-TO-DATE INFORMATION.
2. PLEASE SEE SINGLE PLY FLASHING SPECIFICATIONS FOR A FULL DESCRIPTION OF INSTALLATION
3. INSTRUCTIONS AND REQUIREMENTS WHICH ARE CONSIDERED A PART OF THIS DETAIL.
4. ANY CARPENTRY OR METAL WORK SHOULD BE DESIGNED AND CONSTRUCTED IN ACCORDANCE WITH LOCAL CODE REQUIREMENTS AND/OR PROJECT SPECIFICATIONS. THESE COMPONENTS SHOULD BE REVIEWED AND APPROVED BY A LICENSED DESIGN PROFESSIONAL.
5. CLEAN MEMBRANE SURFACE PRIOR TO ENRGY ANCHOR INSTALLATION WITH JM SINGLE PLY MEMBRANE CLEANER.
6. DO NOT INSTALL ENERGY ANCHORS OVER MEMBRANE SEAMS.

Johns Manville is a manufacturer of commercial roofing products and offers this general conceptual information to you as a courtesy. This complimentary assistance is not to be used or relied upon by anyone as a substitute for professional engineering design and documentation required by building code, contract, or applicable law. By accepting these comments you agree they do not constitute any representations, endorsements of, or an assumption by Johns Manville of any liability for either the adequacy of design of this building or any other material not supplied by Johns Manville.

Note: For the most current information on general guidelines, please refer to the System Considerations tab under Commercial Roofing Products on the JM Roofing Web site. For specifications, flashing details and general installation information please refer to the Application Tools tab.

Refer to the Safe Use Instructions and product label prior to using this product.



JM PVC Safety Strip Over PVC Membrane

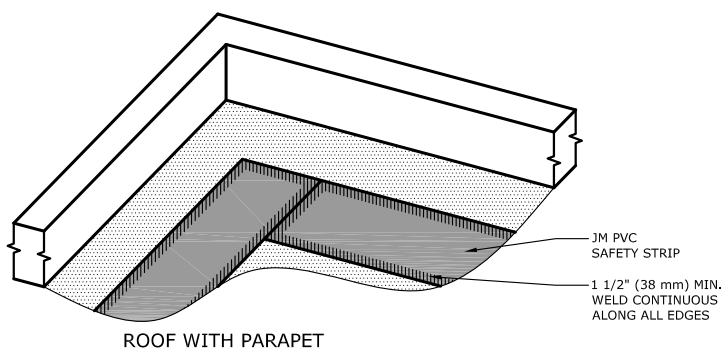

ROOF WITH PARAPET

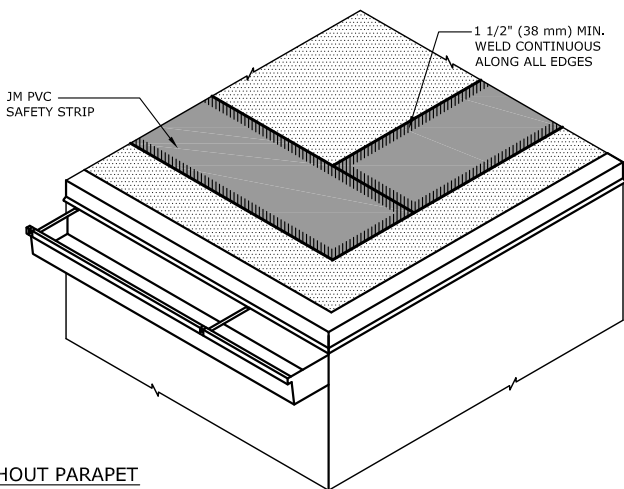

ROOF WITHOUT PARAPET

NOTES:

1. REFER TO JOHNS MANVILLE WEBSITE (www.jm.com) FOR MOST UP-TO-DATE INFORMATION.
2. PLEASE SEE SINGLE PLY FLASHING SPECIFICATIONS FOR A FULL DESCRIPTION OF INSTALLATION INSTRUCTIONS AND REQUIREMENTS WHICH ARE CONSIDERED A PART OF THIS DETAIL.
3. ANY CARPENTRY OR METAL WORK SHOULD BE DESIGNED AND CONSTRUCTED IN ACCORDANCE WITH LOCAL CODE REQUIREMENTS AND/OR PROJECT SPECIFICATIONS. THESE COMPONENTS SHOULD BE REVIEWED AND APPROVED BY A LICENSED DESIGN PROFESSIONAL.
4. MINIMIZE INSTALLING JM PVC SAFETY STRIP OVER SEAMS AND MEMBRANE SPLICES.

Maximum Guarantee Term: 20 Year

Johns Manville is a manufacturer of commercial roofing products and offers this general conceptual information to you as a courtesy. This complimentary assistance is not to be used or relied upon by anyone as a substitute for professional engineering design and documentation required by building code, contract, or applicable law. By accepting these comments you agree they do not constitute any representations, endorsements of, or an assumption by Johns Manville of any liability for either the adequacy of design of this building or any other material not supplied by Johns Manville.

Note: For the most current information on general guidelines, please refer to the System Considerations tab under Commercial Roofing Products on the JM Roofing Web site. For specifications, flashing details and general installation information please refer to the Application Tools tab.

Refer to the Safe Use Instructions and product label prior to using this product.



Drip Edge - PVC Coated Metal

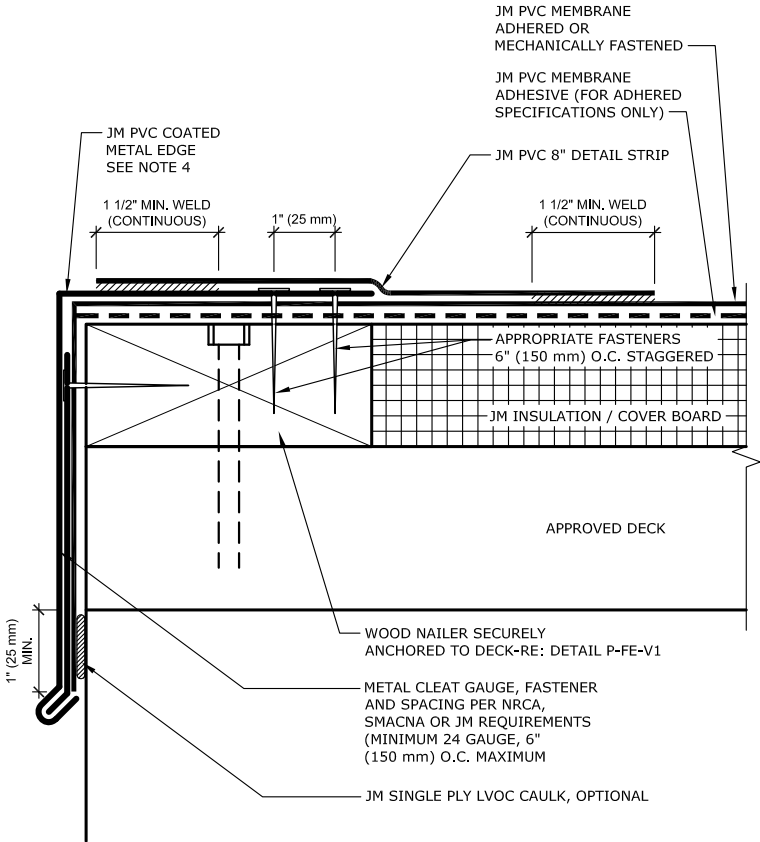

NOTES:

1. REFER TO JOHNS MANVILLE WEBSITE (www.jm.com) FOR MOST UP-TO-DATE INFORMATION.
2. PLEASE SEE SINGLE PLY FLASHING SPECIFICATIONS FOR A FULL DESCRIPTION OF INSTALLATION INSTRUCTIONS AND REQUIREMENTS WHICH ARE CONSIDERED A PART OF THIS DETAIL.
3. ANY CARPENTRY OR METAL WORK SHOULD BE DESIGNED AND CONSTRUCTED IN ACCORDANCE WITH LOCAL CODE REQUIREMENTS AND/OR PROJECT SPECIFICATIONS. THESE COMPONENTS SHOULD BE REVIEWED AND APPROVED BY A LICENSED DESIGN PROFESSIONAL.
4. METAL EDGE SHOWN IS MANUFACTURED BY THE CONTRACTOR USING JM PVC COATED METAL SHEET PRODUCT.

Maximum Guarantee Term: 30 Year

Johns Manville is a manufacturer of commercial roofing products and offers this general conceptual information to you as a courtesy. This complimentary assistance is not to be used or relied upon by anyone as a substitute for professional engineering design and documentation required by building code, contract, or applicable law. By accepting these comments you agree they do not constitute any representations, endorsements of, or an assumption by Johns Manville of any liability for either the adequacy of design of this building or any other material not supplied by Johns Manville.

Note: For the most current information on general guidelines, please refer to the System Considerations tab under Commercial Roofing Products on the JM Roofing Web site. For specifications, flashing details and general installation information please refer to the Application Tools tab.

Refer to the Safe Use Instructions and product label prior to using this product.



Drip Edge Adhered Membrane - PVC Coated Metal

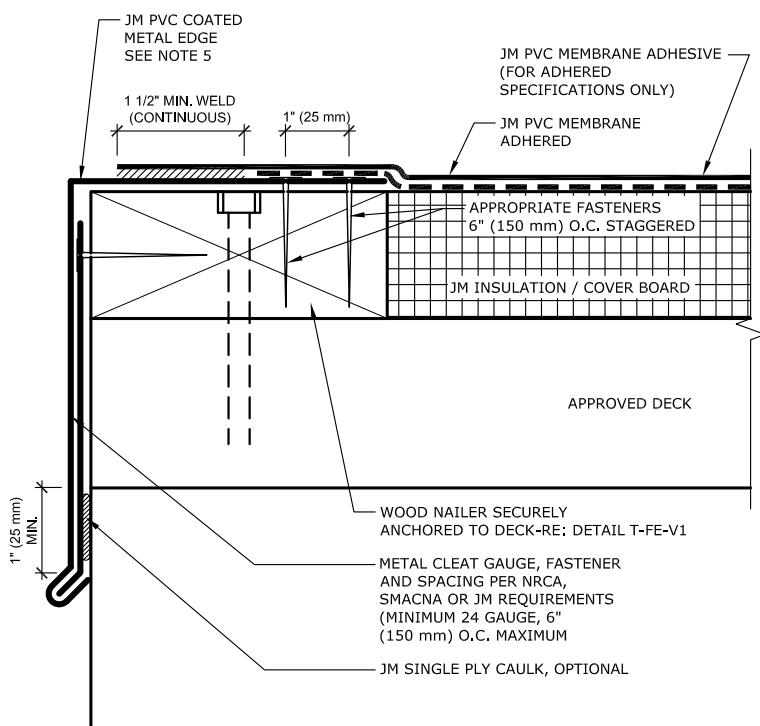

NOTES:

1. REFER TO JOHNS MANVILLE WEBSITE (www.jm.com) FOR MOST UP-TO-DATE INFORMATION.
2. PLEASE SEE SINGLE PLY FLASHING SPECIFICATIONS FOR A FULL DESCRIPTION OF INSTALLATION INSTRUCTIONS AND REQUIREMENTS WHICH ARE CONSIDERED A PART OF THIS DETAIL.
3. ANY CARPENTRY OR METAL WORK SHOULD BE DESIGNED AND CONSTRUCTED IN ACCORDANCE WITH LOCAL CODE REQUIREMENTS AND/OR PROJECT SPECIFICATIONS. THESE COMPONENTS SHOULD BE REVIEWED AND APPROVED BY A LICENSED DESIGN PROFESSIONAL.
4. THIS DETAIL IS ACCEPTABLE FOR ADHERED MEMBRANE SYSTEMS ONLY
5. METAL EDGE SHOWN IS MANUFACTURED BY THE CONTRACTOR USING JM PVC COATED METAL SHEET PRODUCT.

Maximum Guarantee Term: 20 Year

Johns Manville is a manufacturer of commercial roofing products and offers this general conceptual information to you as a courtesy. This complimentary assistance is not to be used or relied upon by anyone as a substitute for professional engineering design and documentation required by building code, contract, or applicable law. By accepting these comments you agree they do not constitute any representations, endorsements of, or an assumption by Johns Manville of any liability for either the adequacy of design of this building or any other material not supplied by Johns Manville.

Note: For the most current information on general guidelines, please refer to the System Considerations tab under Commercial Roofing Products on the JM Roofing Web site. For specifications, flashing details and general installation information please refer to the Application Tools tab.

Refer to the Safe Use Instructions and product label prior to using this product.



Gravel Stop - PVC Coated Metal

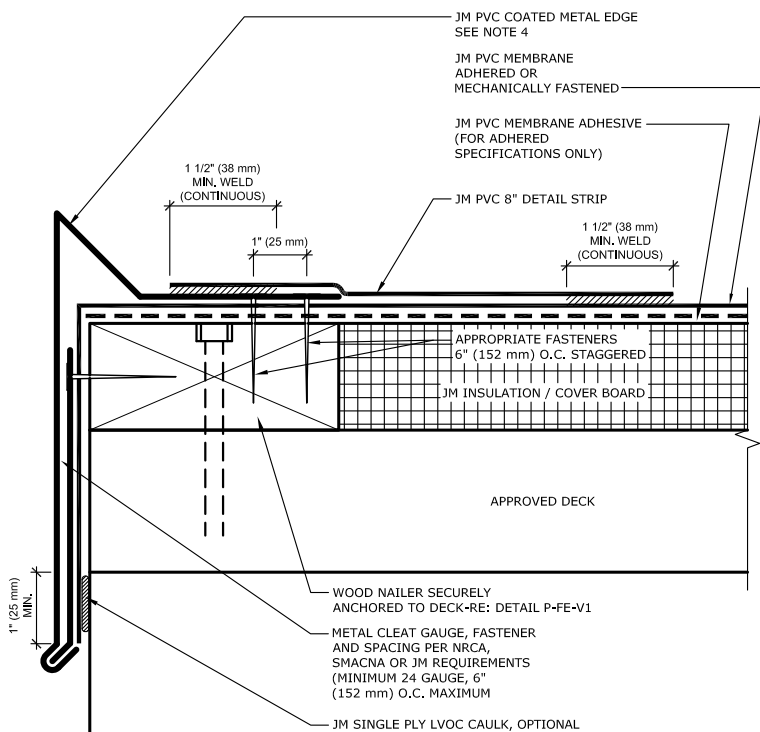

NOTES:

1. REFER TO JOHNS MANVILLE WEBSITE (www.jm.com) FOR MOST UP-TO-DATE INFORMATION
2. PLEASE SEE SINGLE PLY FLASHING SPECIFICATIONS FOR A FULL DESCRIPTION OF INSTALLATION INSTRUCTIONS AND REQUIREMENTS WHICH ARE CONSIDERED A PART OF THIS DETAIL.
3. ANY CARPENTRY OR METAL WORK SHOULD BE DESIGNED AND CONSTRUCTED IN ACCORDANCE WITH LOCAL CODE REQUIREMENTS AND/OR PROJECT SPECIFICATIONS. THESE COMPONENTS SHOULD BE REVIEWED AND APPROVED BY A LICENSED DESIGN PROFESSIONAL.
4. METAL EDGE SHOWN IS MANUFACTURED BY THE CONTRACTOR USING JM PVC COATED METAL SHEET PRODUCT.

Maximum Guarantee Term: 30 Year

Johns Manville is a manufacturer of commercial roofing products and offers this general conceptual information to you as a courtesy. This complimentary assistance is not to be used or relied upon by anyone as a substitute for professional engineering design and documentation required by building code, contract, or applicable law. By accepting these comments you agree they do not constitute any representations, endorsements of, or an assumption by Johns Manville of any liability for either the adequacy of design of this building or any other material not supplied by Johns Manville.

Note: For the most current information on general guidelines, please refer to the System Considerations tab under Commercial Roofing Products on the JM Roofing Web site. For specifications, flashing details and general installation information please refer to the Application Tools tab.

Refer to the Safe Use Instructions and product label prior to using this product.



Gravel Stop - PVC Coated Metal Adhered Membrane Only

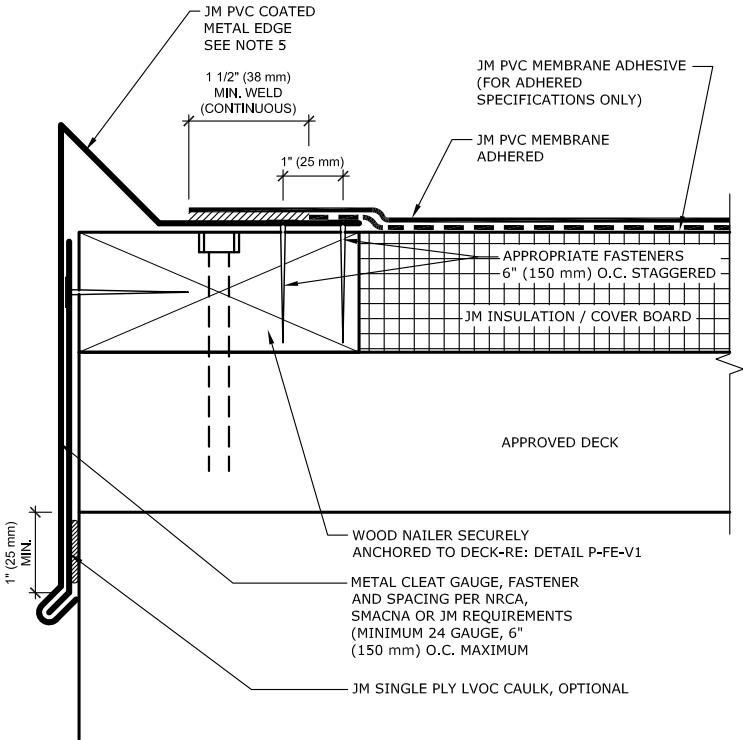

NOTES:

1. REFER TO JOHNS MANVILLE WEBSITE (www.jm.com) FOR MOST UP-TO-DATE INFORMATION.
2. PLEASE SEE SINGLE PLY FLASHING SPECIFICATIONS FOR A FULL DESCRIPTION OF INSTALLATION INSTRUCTIONS AND REQUIREMENTS WHICH ARE CONSIDERED A PART OF THIS DETAIL.
3. ANY CARPENTRY OR METAL WORK SHOULD BE DESIGNED AND CONSTRUCTED IN ACCORDANCE WITH LOCAL CODE REQUIREMENTS AND/OR PROJECT SPECIFICATIONS. THESE COMPONENTS SHOULD BE REVIEWED AND APPROVED BY A LICENSED DESIGN PROFESSIONAL.
4. THIS DETAIL IS ACCEPTABLE FOR USE WITH ADHERED MEMBRANE SYSTEMS ONLY.
5. METAL EDGE SHOWN IS MANUFACTURED BY THE CONTRACTOR USING JM PVC COATED METAL SHEET PRODUCT.

Maximum Guarantee Term: 20 Year

Johns Manville is a manufacturer of commercial roofing products and offers this general conceptual information to you as a courtesy. This complimentary assistance is not to be used or relied upon by anyone as a substitute for professional engineering design and documentation required by building code, contract, or applicable law. By accepting these comments you agree they do not constitute any representations, endorsements of, or an assumption by Johns Manville of any liability for either the adequacy of design of this building or any other material not supplied by Johns Manville.

Note: For the most current information on general guidelines, please refer to the System Considerations tab under Commercial Roofing Products on the JM Roofing Web site. For specifications, flashing details and general installation information please refer to the Application Tools tab.

Refer to the Safe Use Instructions and product label prior to using this product.



Gutter & PVC Coated Metal Edge

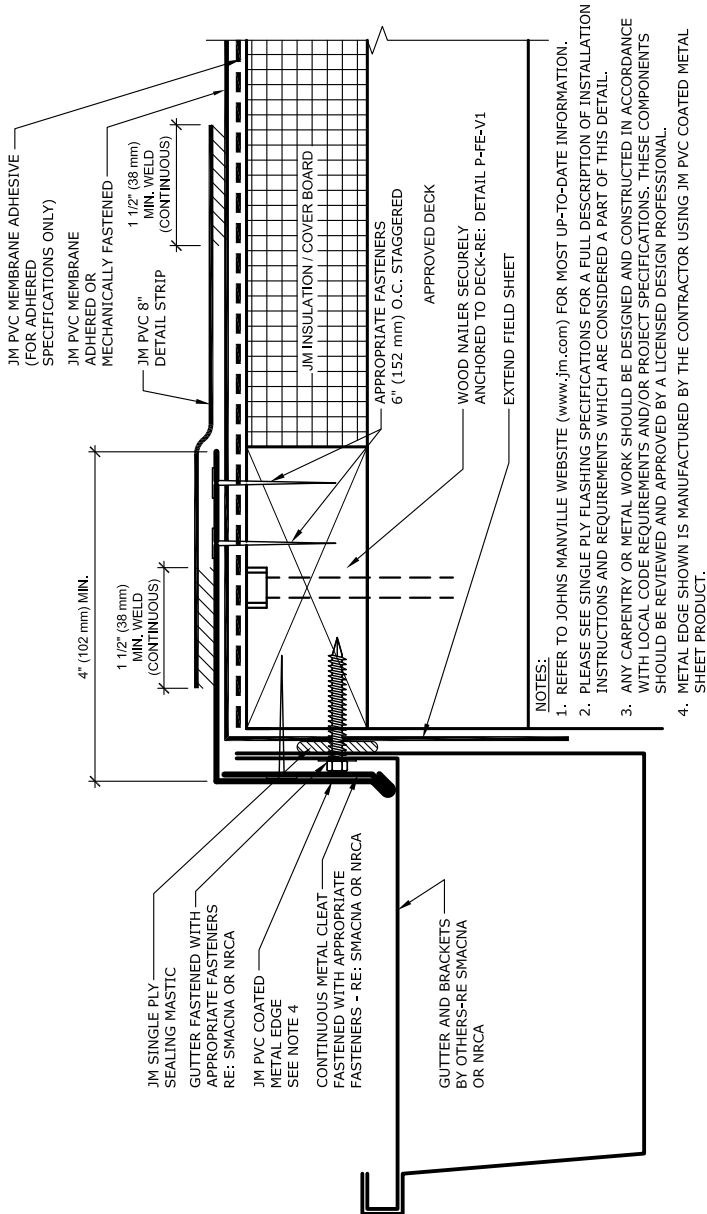

Maximum Guarantee Term: 30 Year

Johns Manville is a manufacturer of commercial roofing products and offers this general conceptual information to you as a courtesy. This complimentary assistance is not to be used or relied upon by anyone as a substitute for professional engineering design and documentation required by building code, contract, or applicable law. By accepting these comments you agree they do not constitute any representations, endorsements of, or an assumption by Johns Manville of any liability for either the adequacy of design of this building or any other material not supplied by Johns Manville.

Note: For the most current information on general guidelines, please refer to the System Considerations tab under Commercial Roofing Products on the JM Roofing Web site. For specifications, flashing details and general installation information please refer to the Application Tools tab.

Refer to the Safe Use Instructions and product label prior to using this product.



Butt Joint At Edge - PVC Coated Metal

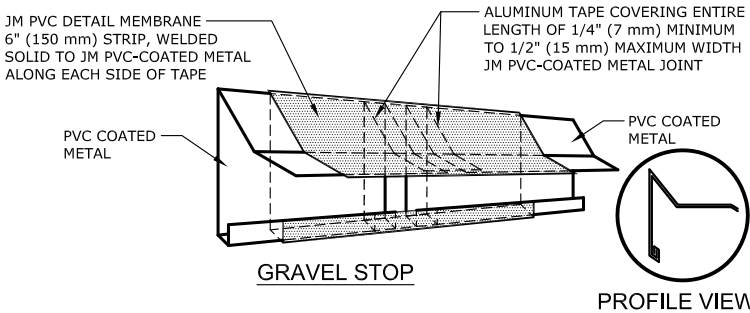
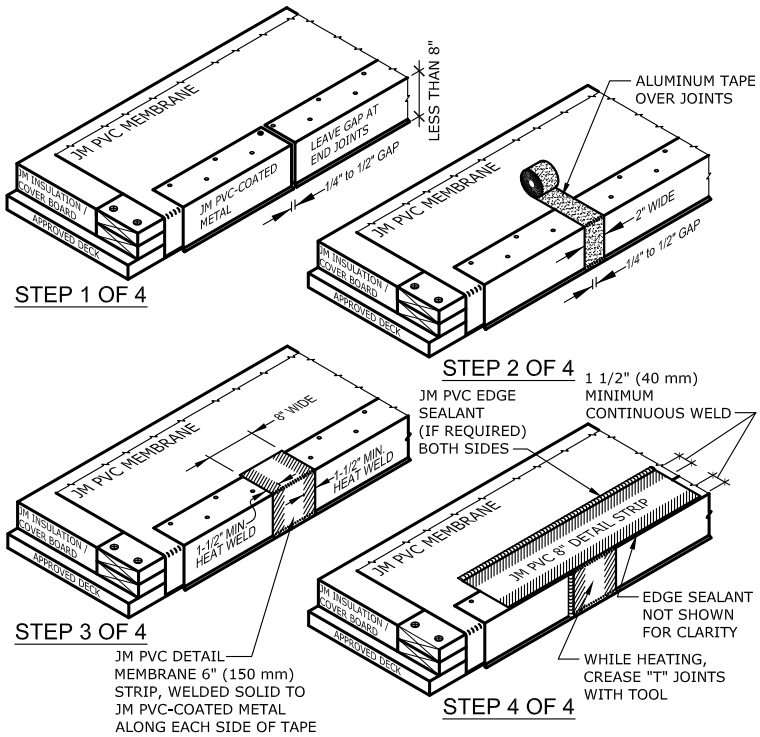

NOTES:

1. REFER TO JOHNS MANVILLE WEBSITE (www.jm.com) FOR MOST UP-TO-DATE INFORMATION.
2. PLEASE SEE SINGLE PLY FLASHING SPECIFICATIONS FOR A FULL DESCRIPTION OF INSTALLATION INSTRUCTIONS AND REQUIREMENTS WHICH ARE CONSIDERED A PART OF THIS DETAIL.
3. ANY CARPENTRY OR METAL WORK SHOULD BE DESIGNED AND CONSTRUCTED IN ACCORDANCE WITH LOCAL CODE REQUIREMENTS AND/OR PROJECT SPECIFICATIONS. THESE COMPONENTS SHOULD BE REVIEWED AND APPROVED BY A LICENSED DESIGN PROFESSIONAL.

Maximum Guarantee Term: 30 Year

Johns Manville is a manufacturer of commercial roofing products and offers this general conceptual information to you as a courtesy. This complimentary assistance is not to be used or relied upon by anyone as a substitute for professional engineering design and documentation required by building code, contract, or applicable law. By accepting these comments you agree they do not constitute any representations, endorsements of, or an assumption by Johns Manville of any liability for either the adequacy of design of this building or any other material not supplied by Johns Manville.

Note: For the most current information on general guidelines, please refer to the System Considerations tab under Commercial Roofing Products on the JM Roofing Web site. For specifications, flashing details and general installation information please refer to the Application Tools tab.

Refer to the Safe Use Instructions and product label prior to using this product.



JM Presto - Lock Fascia System

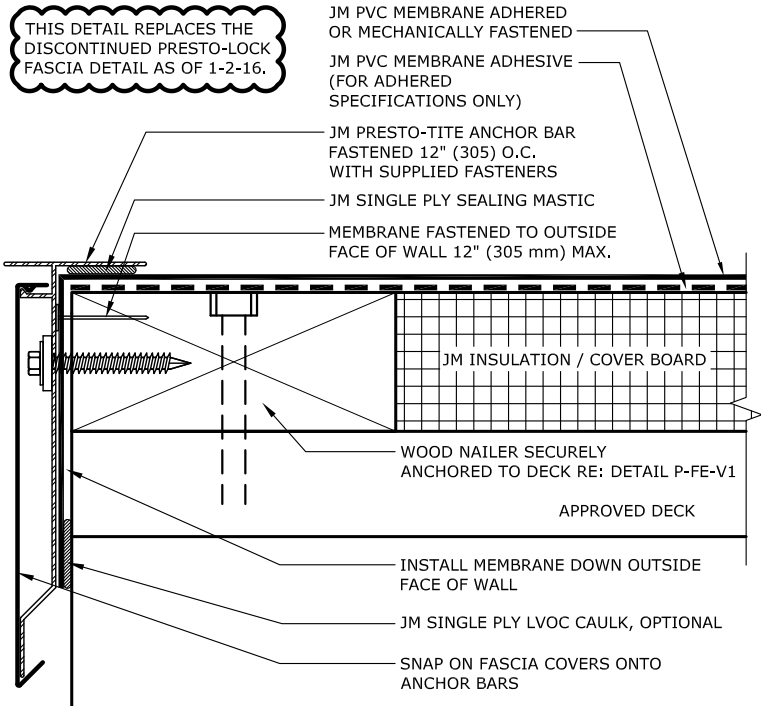

NOTES:

1. REFER TO JOHNS MANVILLE WEBSITE (www.jm.com) FOR MOST UP-TO-DATE INFORMATION.
2. PLEASE SEE SINGLE PLY FLASHING SPECIFICATIONS FOR A FULL DESCRIPTION OF INSTALLATION INSTRUCTIONS AND REQUIREMENTS WHICH ARE CONSIDERED A PART OF THIS DETAIL.
3. ANY CARPENTRY OR METAL WORK SHOULD BE DESIGNED AND CONSTRUCTED IN ACCORDANCE WITH LOCAL CODE REQUIREMENTS AND/OR PROJECT SPECIFICATIONS. THESE COMPONENTS SHOULD BE REVIEWED AND APPROVED BY A LICENSED DESIGN PROFESSIONAL.

Maximum Guarantee Term: 30 Year

Johns Manville is a manufacturer of commercial roofing products and offers this general conceptual information to you as a courtesy. This complimentary assistance is not to be used or relied upon by anyone as a substitute for professional engineering design and documentation required by building code, contract, or applicable law. By accepting these comments you agree they do not constitute any representations, endorsements of, or an assumption by Johns Manville of any liability for either the adequacy of design of this building or any other material not supplied by Johns Manville.

Note: For the most current information on general guidelines, please refer to the System Considerations tab under Commercial Roofing Products on the JM Roofing Web site. For specifications, flashing details and general installation information please refer to the Application Tools tab.

Refer to the Safe Use Instructions and product label prior to using this product.



JM Presto-Tite Fascia System For Single Ply Systems

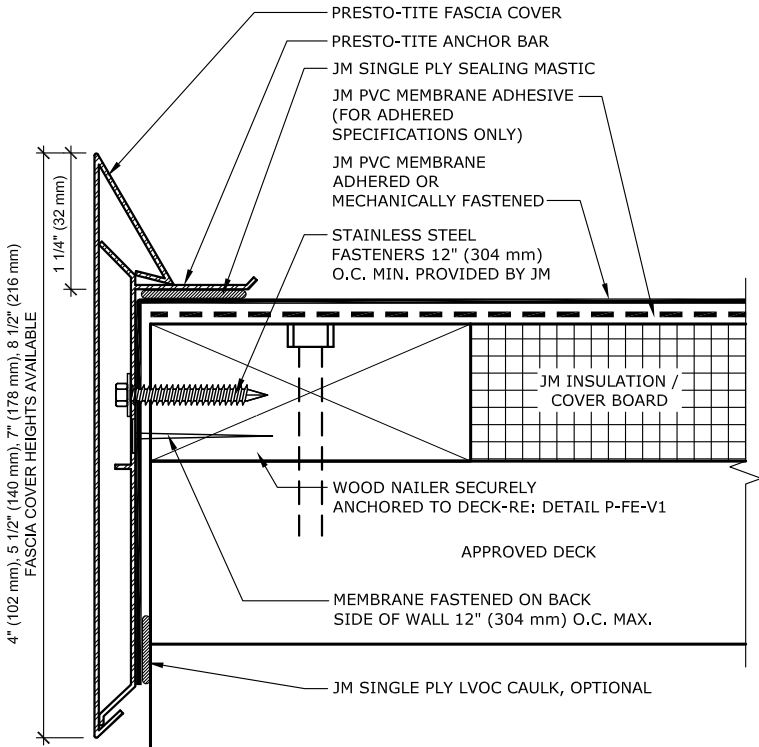

NOTES:

1. REFER TO JOHNS MANVILLE WEBSITE (www.jm.com) FOR MOST UP-TO-DATE INFORMATION.
2. PLEASE SEE SINGLE PLY FLASHING SPECIFICATIONS FOR A FULL DESCRIPTION OF INSTALLATION INSTRUCTIONS AND REQUIREMENTS WHICH ARE CONSIDERED A PART OF THIS DETAIL.
3. ANY CARPENTRY OR METAL WORK SHOULD BE DESIGNED AND CONSTRUCTED IN ACCORDANCE WITH LOCAL CODE REQUIREMENTS AND/OR PROJECT SPECIFICATIONS. THESE COMPONENTS SHOULD BE REVIEWED AND APPROVED BY A LICENSED DESIGN PROFESSIONAL.

Maximum Guarantee Term: 30 Year

Johns Manville is a manufacturer of commercial roofing products and offers this general conceptual information to you as a courtesy. This complimentary assistance is not to be used or relied upon by anyone as a substitute for professional engineering design and documentation required by building code, contract, or applicable law. By accepting these comments you agree they do not constitute any representations, endorsements of, or an assumption by Johns Manville of any liability for either the adequacy of design of this building or any other material not supplied by Johns Manville.

Note: For the most current information on general guidelines, please refer to the System Considerations tab under Commercial Roofing Products on the JM Roofing Web site. For specifications, flashing details and general installation information please refer to the Application Tools tab.

Refer to the Safe Use Instructions and product label prior to using this product.



JM Rail Fascia System For Single Ply Roof

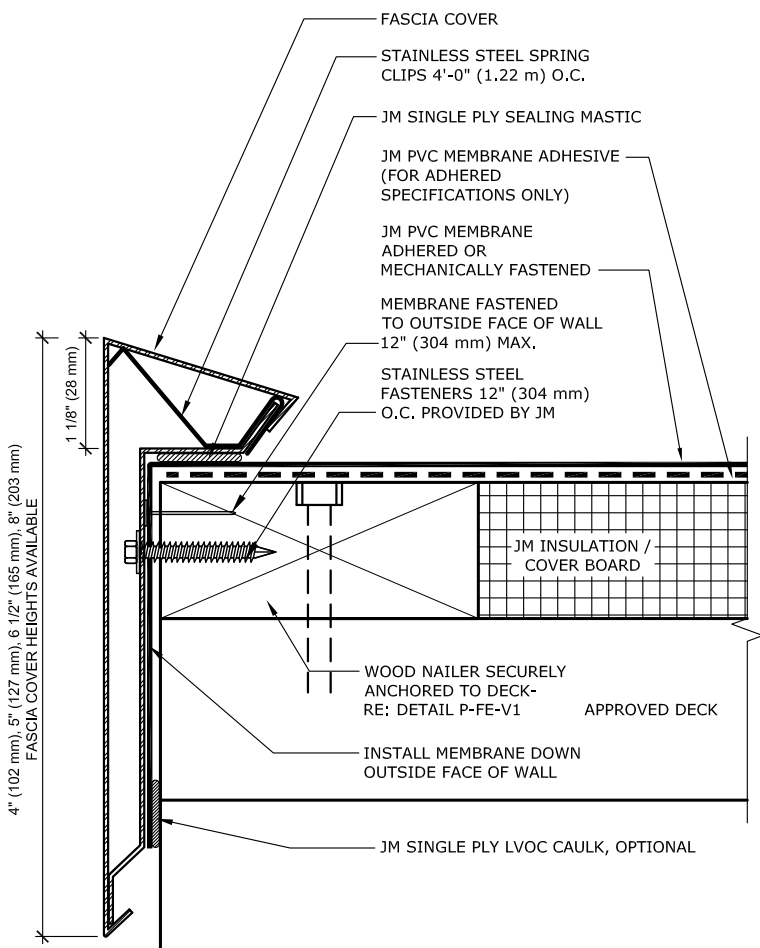

NOTES:

1. REFER TO JOHNS MANVILLE WEBSITE (www.jm.com) FOR MOST UP-TO-DATE INFORMATION
2. PLEASE SEE SINGLE PLY FLASHING SPECIFICATIONS FOR A FULL DESCRIPTION OF INSTALLATION INSTRUCTIONS AND REQUIREMENTS WHICH ARE CONSIDERED A PART OF THIS DETAIL.
3. ANY CARPENTRY OR METAL WORK SHOULD BE DESIGNED AND CONSTRUCTED IN ACCORDANCE WITH LOCAL CODE REQUIREMENTS AND/OR PROJECT SPECIFICATIONS. THESE COMPONENTS SHOULD BE REVIEWED AND APPROVED BY A LICENSED DESIGN PROFESSIONAL.

Maximum Guarantee Term: 30 Year

Johns Manville is a manufacturer of commercial roofing products and offers this general conceptual information to you as a courtesy. This complimentary assistance is not to be used or relied upon by anyone as a substitute for professional engineering design and documentation required by building code, contract, or applicable law. By accepting these comments you agree they do not constitute any representations, endorsements of, or an assumption by Johns Manville of any liability for either the adequacy of design of this building or any other material not supplied by Johns Manville.

Note: For the most current information on general guidelines, please refer to the System Considerations tab under Commercial Roofing Products on the JM Roofing Web site. For specifications, flashing details and general installation information please refer to the Application Tools tab.

Refer to the Safe Use Instructions and product label prior to using this product.



JM Perma-Tite System 200 Fascia Over PVC

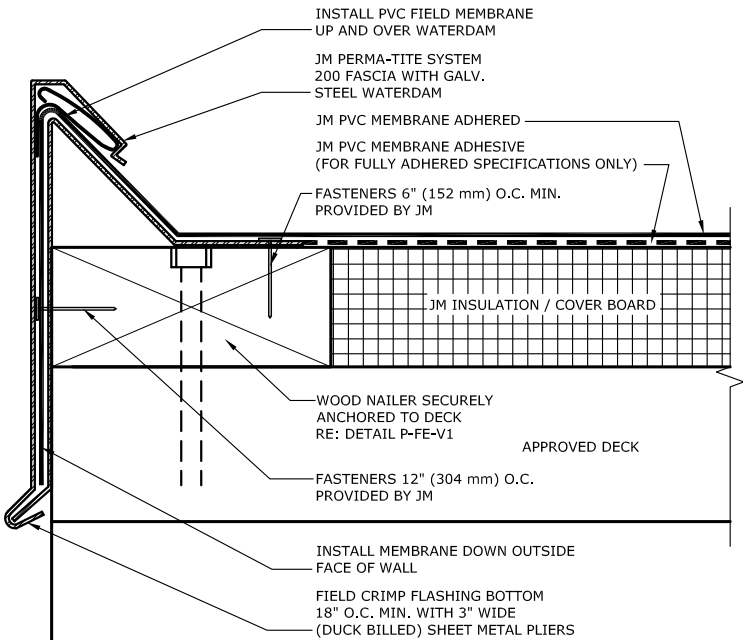

NOTES:

1. REFER TO JOHNS MANVILLE WEBSITE (www.jm.com) FOR MOST UP-TO-DATE INFORMATION
2. PLEASE SEE SINGLE PLY FLASHING SPECIFICATIONS FOR A FULL DESCRIPTION OF INSTALLATION INSTRUCTIONS AND REQUIREMENTS WHICH ARE CONSIDERED A PART OF THIS DETAIL.
3. ANY CARPENTRY OR METAL WORK SHOULD BE DESIGNED AND CONSTRUCTED IN ACCORDANCE WITH LOCAL CODE REQUIREMENTS AND/OR PROJECT SPECIFICATIONS. THESE COMPONENTS SHOULD BE REVIEWED AND APPROVED BY A LICENSED DESIGN PROFESSIONAL.

Maximum Guarantee Term: 30 Year

Johns Manville is a manufacturer of commercial roofing products and offers this general conceptual information to you as a courtesy. This complimentary assistance is not to be used or relied upon by anyone as a substitute for professional engineering design and documentation required by building code, contract, or applicable law. By accepting these comments you agree they do not constitute any representations, endorsements of, or an assumption by Johns Manville of any liability for either the adequacy of design of this building or any other material not supplied by Johns Manville.

Note: For the most current information on general guidelines, please refer to the System Considerations tab under Commercial Roofing Products on the JM Roofing Web site. For specifications, flashing details and general installation information please refer to the Application Tools tab.

Refer to the Safe Use Instructions and product label prior to using this product.



PM Pesto Weld Drip Edge

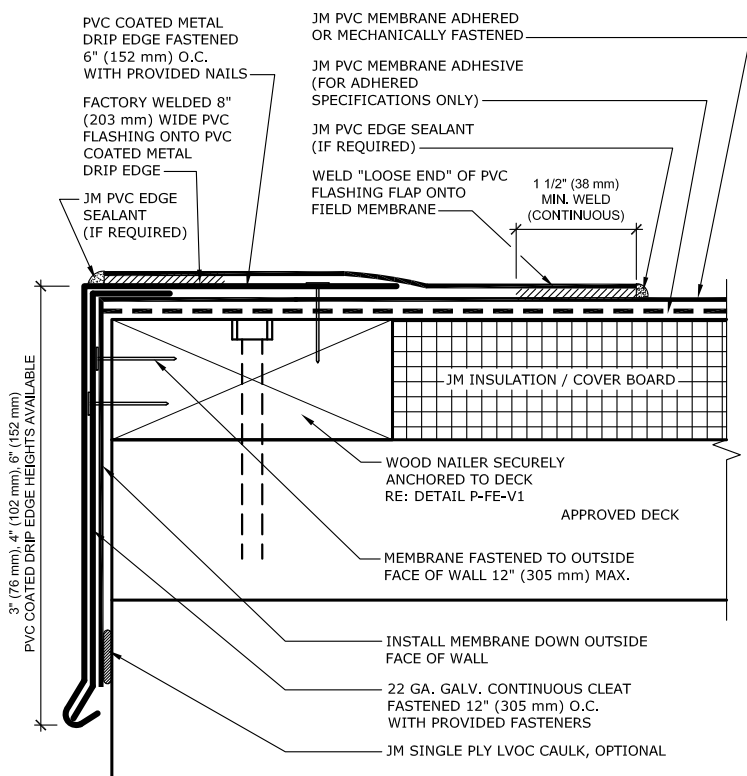

NOTES:

1. REFER TO JOHNS MANVILLE WEBSITE (www.jm.com) FOR MOST UP-TO-DATE INFORMATION.
2. PLEASE SEE SINGLE PLY FLASHING SPECIFICATIONS FOR A FULL DESCRIPTION OF INSTALLATION INSTRUCTIONS AND REQUIREMENTS WHICH ARE CONSIDERED A PART OF THIS DETAIL.
3. ANY CARPENTRY OR METAL WORK SHOULD BE DESIGNED AND CONSTRUCTED IN ACCORDANCE WITH LOCAL CODE REQUIREMENTS AND/OR PROJECT SPECIFICATIONS. THESE COMPONENTS SHOULD BE REVIEWED AND APPROVED BY A LICENSED DESIGN PROFESSIONAL.

Maximum Guarantee Term: 30 Year

Johns Manville is a manufacturer of commercial roofing products and offers this general conceptual information to you as a courtesy. This complimentary assistance is not to be used or relied upon by anyone as a substitute for professional engineering design and documentation required by building code, contract, or applicable law. By accepting these comments you agree they do not constitute any representations, endorsements of, or an assumption by Johns Manville of any liability for either the adequacy of design of this building or any other material not supplied by Johns Manville.

Note: For the most current information on general guidelines, please refer to the System Considerations tab under Commercial Roofing Products on the JM Roofing Web site. For specifications, flashing details and general installation information please refer to the Application Tools tab.

Refer to the Safe Use Instructions and product label prior to using this product.



Wood Nailer Attachment

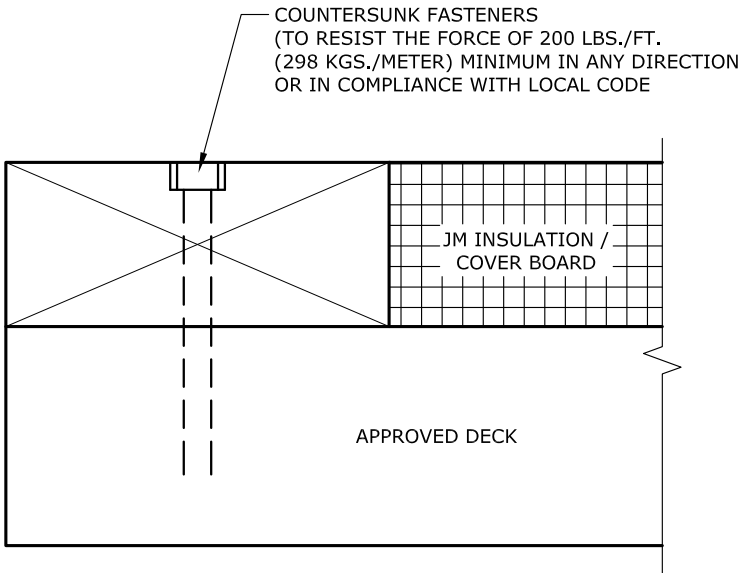

NOTES:

1. REFER TO JOHNS MANVILLE WEBSITE (www.jm.com) FOR MOST UP-TO-DATE INFORMATION.
2. PLEASE SEE SINGLE PLY FLASHING SPECIFICATIONS FOR A FULL DESCRIPTION OF INSTALLATION INSTRUCTIONS AND REQUIREMENTS WHICH ARE CONSIDERED A PART OF THIS DETAIL.
3. ANY CARPENTRY OR METAL WORK SHOULD BE DESIGNED AND CONSTRUCTED IN ACCORDANCE WITH LOCAL CODE REQUIREMENTS AND/OR PROJECT SPECIFICATIONS. THESE COMPONENTS SHOULD BE REVIEWED AND APPROVED BY A LICENSED DESIGN PROFESSIONAL.

Maximum Guarantee Term: 20 Year

Johns Manville is a manufacturer of commercial roofing products and offers this general conceptual information to you as a courtesy. This complimentary assistance is not to be used or relied upon by anyone as a substitute for professional engineering design and documentation required by building code, contract, or applicable law. By accepting these comments you agree they do not constitute any representations, endorsements of, or an assumption by Johns Manville of any liability for either the adequacy of design of this building or any other material not supplied by Johns Manville.

Note: For the most current information on general guidelines, please refer to the System Considerations tab under Commercial Roofing Products on the JM Roofing Web site. For specifications, flashing details and general installation information please refer to the Application Tools tab.

Refer to the Safe Use Instructions and product label prior to using this product.



Gutter & Termination Bar

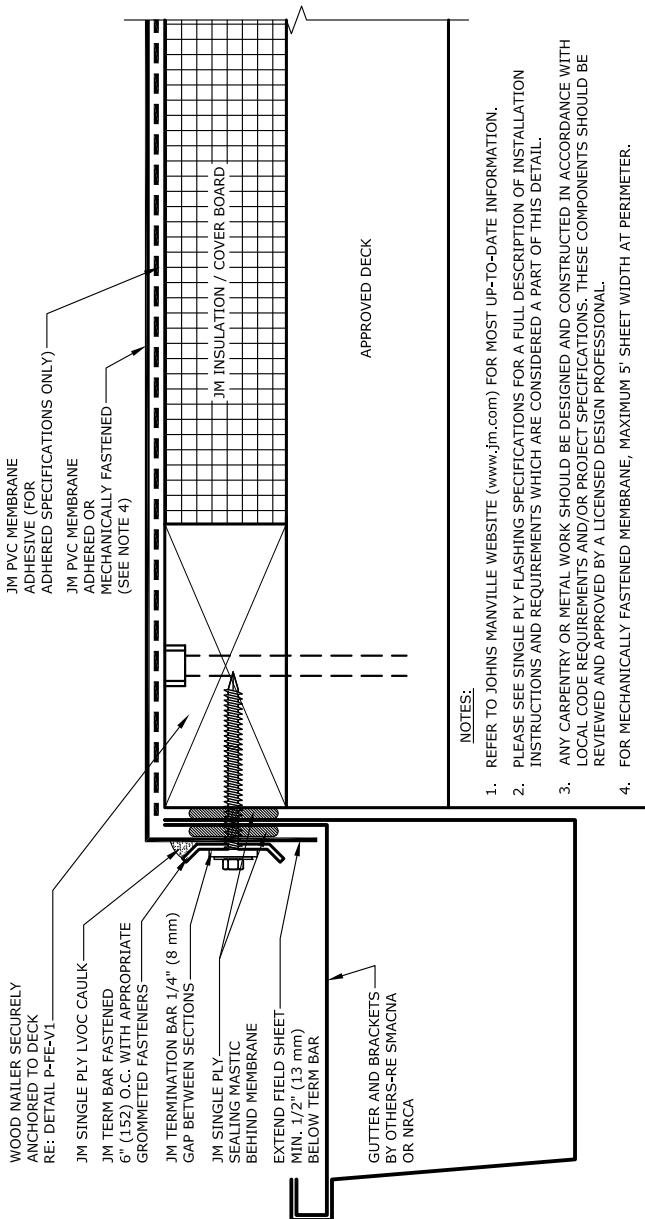

NOTES:

1. REFER TO JOHNS MANVILLE WEBSITE (www.jm.com) FOR MOST UP-TO-DATE INFORMATION.
2. PLEASE SEE SINGLE PLY FLASHING SPECIFICATIONS FOR A FULL DESCRIPTION OF INSTALLATION INSTRUCTIONS AND REQUIREMENTS WHICH ARE CONSIDERED A PART OF THIS DETAIL.
3. ANY CARPENTRY OR METAL WORK SHOULD BE DESIGNED AND CONSTRUCTED IN ACCORDANCE WITH LOCAL CODE REQUIREMENTS AND/OR PROJECT SPECIFICATIONS. THESE COMPONENTS SHOULD BE REVIEWED AND APPROVED BY A LICENSED DESIGN PROFESSIONAL.
4. FOR MECHANICALLY FASTENED MEMBRANE, MAXIMUM 5' SHEET WIDTH AT PERIMETER.

Maximum Guarantee Term: 20 Year

Johns Manville is a manufacturer of commercial roofing products and offers this general conceptual information to you as a courtesy. This complimentary assistance is not to be used or relied upon by anyone as a substitute for professional engineering design and documentation required by building code, contract, or applicable law. By accepting these comments you agree they do not constitute any representations, endorsements of, or an assumption by Johns Manville of any liability for either the adequacy of design of this building or any other material not supplied by Johns Manville.

Note: For the most current information on general guidelines, please refer to the System Considerations tab under Commercial Roofing Products on the JM Roofing Web site. For specifications, flashing details and general installation information please refer to the Application Tools tab.

Refer to the Safe Use Instructions and product label prior to using this product.



RhinoPlate - Standing Seam Retro Fit Purlin Attachment

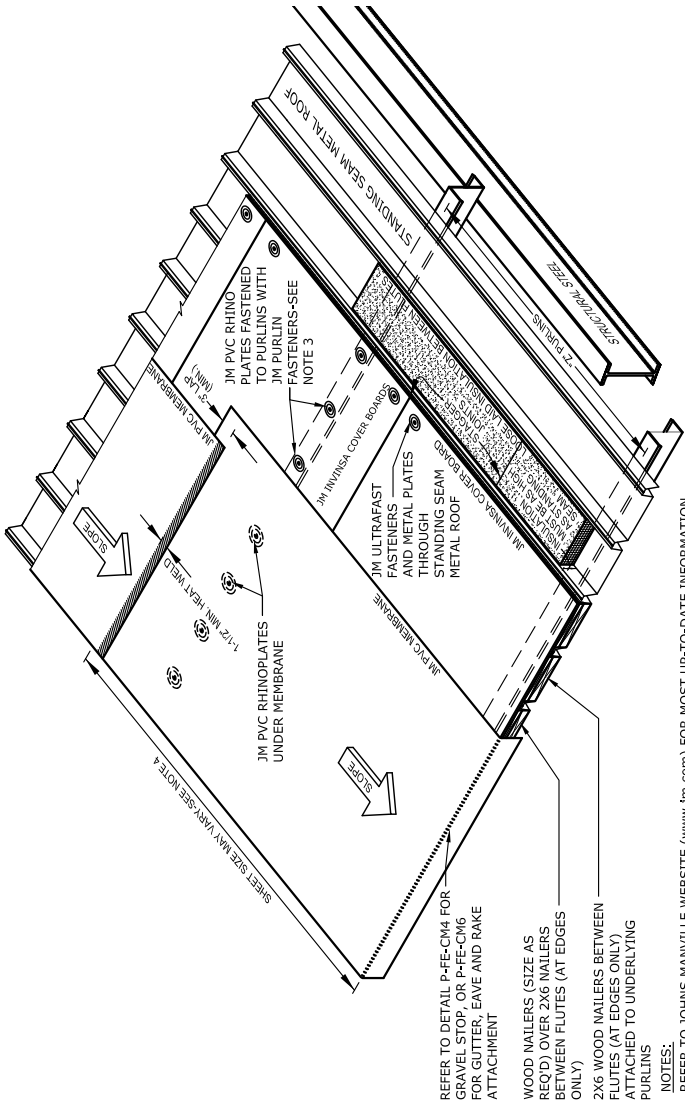

NOTES:

- REFER TO JOHNS MANVILLE WEBSITE (www.jm.com) FOR MOST UP-TO-DATE INFORMATION.
- PLEASE SEE SINGLE PLY FLASHING SPECIFICATIONS FOR A FULL DESCRIPTION OF INSTALLATION INSTRUCTIONS AND REQUIREMENTS WHICH ARE CONSIDERED A PART OF THIS DETAIL.
- ANY CARPENTRY OR METAL WORK SHOULD BE DESIGNED AND CONSTRUCTED IN ACCORDANCE WITH LOCAL CODE REQUIREMENTS AND/OR PROJECT SPECIFICATIONS. THESE COMPONENTS SHOULD BE REVIEWED AND APPROVED BY A LICENSED DESIGN PROFESSIONAL.
- SHEET LAPS MUST NOT END ON FASTENERS.

Maximum Guarantee Term: 20 Year

Johns Manville is a manufacturer of commercial roofing products and offers this general conceptual information to you as a courtesy. This complimentary assistance is not to be used or relied upon by anyone as a substitute for professional engineering design and documentation required by building code, contract, or applicable law. By accepting these comments you agree they do not constitute any representations, endorsements of, or an assumption by Johns Manville of any liability for either the adequacy of design of this building or any other material not supplied by Johns Manville.

Note: For the most current information on general guidelines, please refer to the System Considerations tab under Commercial Roofing Products on the JM Roofing Web site. For specifications, flashing details and general installation information please refer to the Application Tools tab.

Refer to the Safe Use Instructions and product label prior to using this product.

PVC Flashing Details



RhinoPlate - Standing Seam Retro Fit Gravel Stop

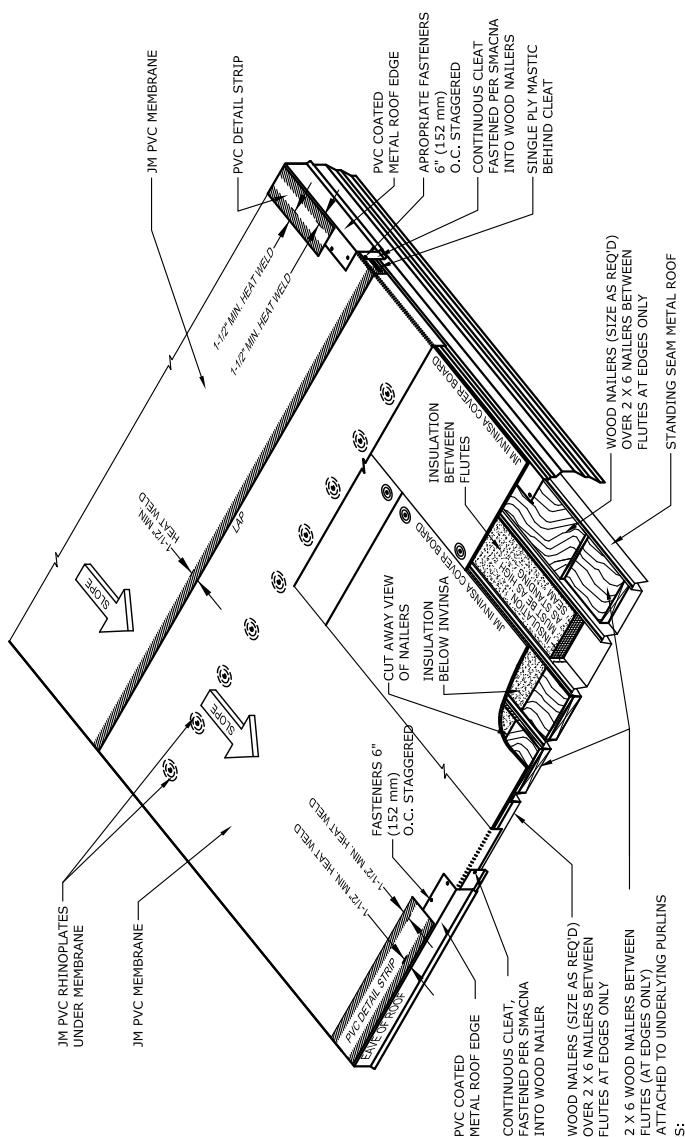

- NOTES:**
1. REFER TO JOHNS MANVILLE WEBSITE (www.jm.com) FOR MOST UP-TO-DATE INFORMATION.
 2. SEE SINGLE PLY FLASHING SPECIFICATIONS FOR A FULL DESCRIPTION OF INSTALLATION INSTRUCTIONS AND REQUIREMENTS WHICH ARE CONSIDERED A PART OF THIS DETAIL.
 3. ANY CARPENTRY OR METAL WORK SHOULD BE DESIGNED AND CONSTRUCTED IN ACCORDANCE WITH LOCAL CODE REQUIREMENTS AND/OR PROJECT SPECIFICATIONS. THESE COMPONENTS SHOULD BE REVIEWED AND APPROVED BY A LICENSED DESIGN PROFESSIONAL.
 4. JM PVC EDGE SEALANT IS OPTIONAL ON ALL CUT OR NON-ENCAPSULATED EDGES OF REINFORCED MEMBRANE. THIS INCLUDES FACTORY CUT MEMBRANE. SEE DETAIL P-MS-01).

Maximum Guarantee Term: 20 Year

Johns Manville is a manufacturer of commercial roofing products and offers this general conceptual information to you as a courtesy. This complimentary assistance is not to be used or relied upon by anyone as a substitute for professional engineering design and documentation required by building code, contract, or applicable law. By accepting these comments you agree they do not constitute any representations, endorsements of, or an assumption by Johns Manville of any liability for either the adequacy of design of this building or any other material not supplied by Johns Manville.

Note: For the most current information on general guidelines, please refer to the System Considerations tab under Commercial Roofing Products on the JM Roofing Web site. For specifications, flashing details and general installation information please refer to the Application Tools tab.

Refer to the Safe Use Instructions and product label prior to using this product.



RhinoPlate - Standing Seam Retro Fit Gutter

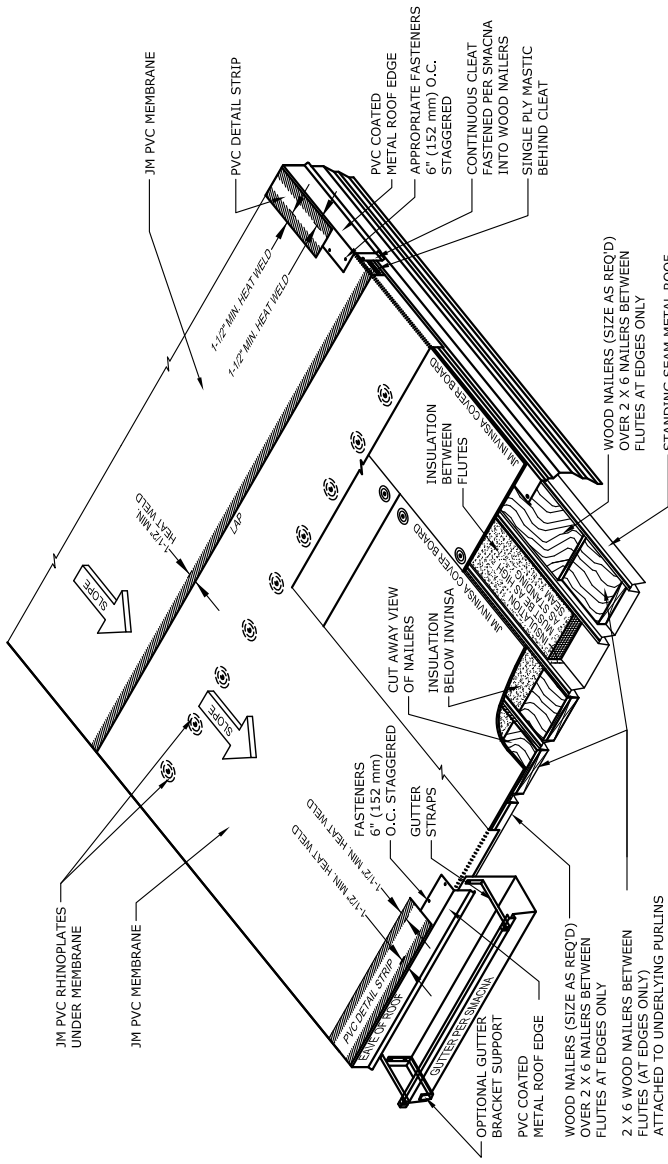

- NOTES:**
1. REFER TO JOHN'S MANVILLE WEBSITE (www.jm.com) FOR MOST UP-TO-DATE INFORMATION.
 2. SEE SINGLE PLY FLASHING SPECIFICATIONS FOR A FULL DESCRIPTION OF INSTALLATION INSTRUCTIONS AND REQUIREMENTS WHICH ARE CONSIDERED A PART OF THIS DETAIL.
 3. ANY CARPENTRY OR METAL WORK SHOULD BE DESIGNED AND CONSTRUCTED IN ACCORDANCE WITH LOCAL CODE REQUIREMENTS AND/OR PROJECT SPECIFICATIONS. THESE COMPONENTS SHOULD BE REVIEWED AND APPROVED BY A LICENSED DESIGN PROFESSIONAL.
 4. JM PVC EDGE SEALANT IS OPTIONAL ON ALL CUT OR NON-ENCAPSULATED EDGES OF REINFORCED MEMBRANE. THIS INCLUDES FACTORY CUT MEMBRANE. SEE DETAIL P-MS-01).

Maximum Guarantee Term: 20 Year

Johns Manville is a manufacturer of commercial roofing products and offers this general conceptual information to you as a courtesy. This complimentary assistance is not to be used or relied upon by anyone as a substitute for professional engineering design and documentation required by building code, contract, or applicable law. By accepting these comments you agree they do not constitute any representations, endorsements of, or an assumption by Johns Manville of any liability for either the adequacy of design of this building or any other material not supplied by Johns Manville.

Note: For the most current information on general guidelines, please refer to the System Considerations tab under Commercial Roofing Products on the JM Roofing Web site. For specifications, flashing details and general installation information please refer to the Application Tools tab.

Refer to the Safe Use Instructions and product label prior to using this product.



Vent Pipe

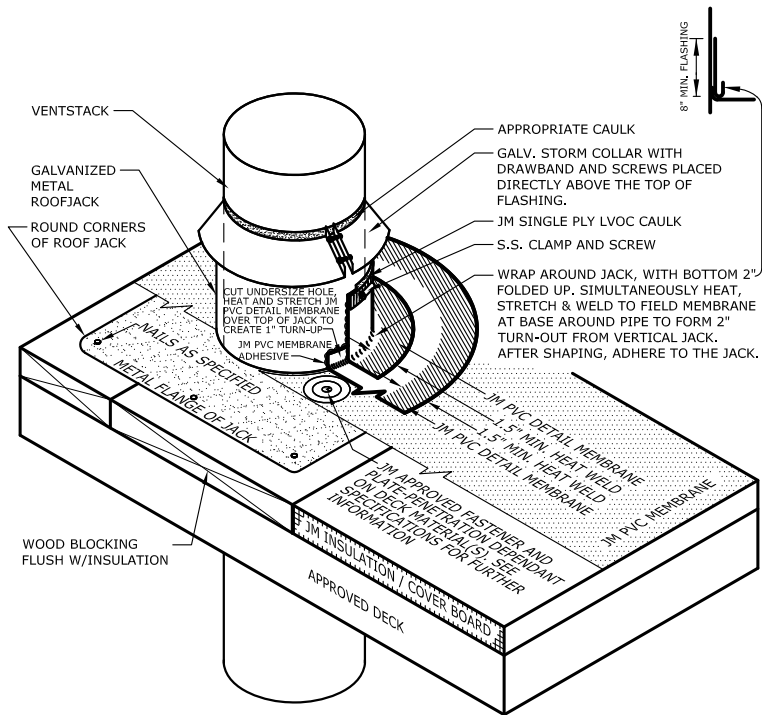

NOTES:

1. REFER TO JOHNS MANVILLE WEBSITE (www.jm.com) FOR MOST UP-TO-DATE INFORMATION.
2. PLEASE SEE SINGLE PLY FLASHING SPECIFICATIONS FOR A FULL DESCRIPTION OF INSTALLATION INSTRUCTIONS AND REQUIREMENTS WHICH ARE CONSIDERED A PART OF THIS DETAIL.
3. ANY CARPENTRY OR METAL WORK SHOULD BE DESIGNED AND CONSTRUCTED IN ACCORDANCE WITH LOCAL CODE REQUIREMENTS AND/OR PROJECT SPECIFICATIONS. THESE COMPONENTS SHOULD BE REVIEWED AND APPROVED BY A LICENSED DESIGN PROFESSIONAL.

Maximum Guarantee Term: 30 Year

Johns Manville is a manufacturer of commercial roofing products and offers this general conceptual information to you as a courtesy. This complimentary assistance is not to be used or relied upon by anyone as a substitute for professional engineering design and documentation required by building code, contract, or applicable law. By accepting these comments you agree they do not constitute any representations, endorsements of, or an assumption by Johns Manville of any liability for either the adequacy of design of this building or any other material not supplied by Johns Manville.

Note: For the most current information on general guidelines, please refer to the System Considerations tab under Commercial Roofing Products on the JM Roofing Web site. For specifications, flashing details and general installation information please refer to the Application Tools tab.

Refer to the Safe Use Instructions and product label prior to using this product.



Vent Pipe - Hot

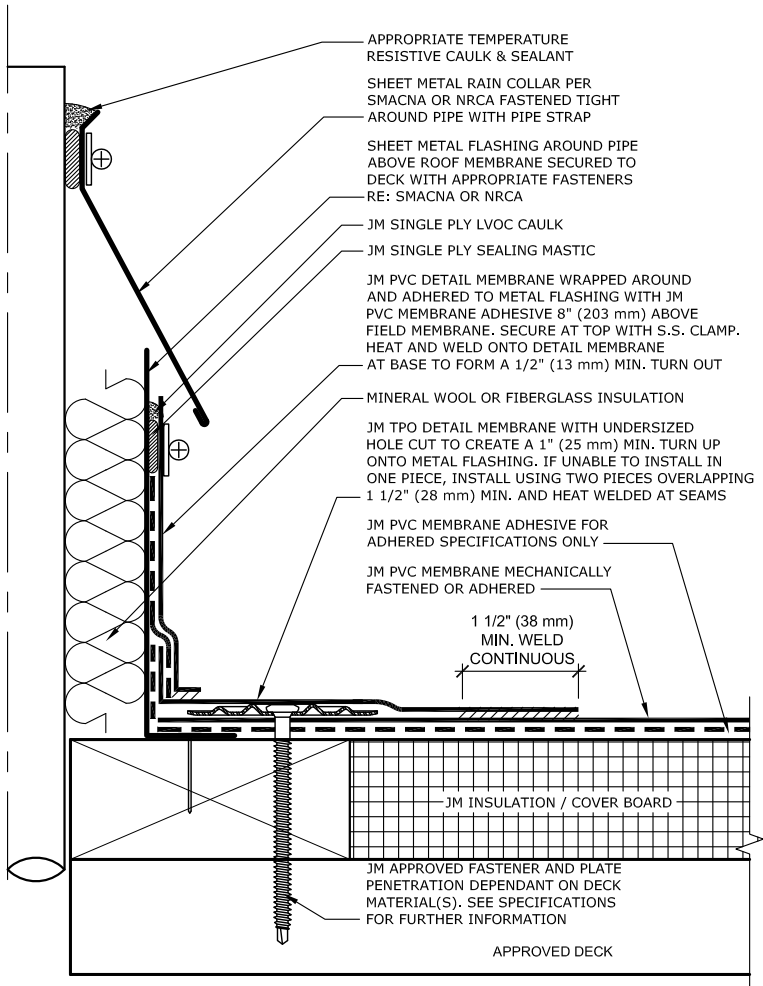

NOTES:

1. REFER TO JOHNS MANVILLE WEBSITE (www.jm.com) FOR MOST UP TO DATE INFORMATION.
2. PLEASE SEE SINGLE PLY FLASHING SPECIFICATIONS FOR A FULL DESCRIPTION OF INSTALLATION INSTRUCTIONS AND REQUIREMENTS WHICH ARE CONSIDERED A PART OF THIS DETAIL.
3. ANY CARPENTRY OR METAL WORK SHOULD BE DESIGNED AND CONSTRUCTED IN ACCORDANCE WITH LOCAL CODE REQUIREMENTS AND/OR PROJECT SPECIFICATIONS. THESE COMPONENTS SHOULD BE REVIEWED AND APPROVED BY A LICENSED DESIGN PROFESSIONAL.
4. MAXIMUM 150 DEGREES FAHRENHEIT AT SURFACE OF OUTER SHEET METAL FLASHING.

Maximum Guarantee Term: 20 Year

Johns Manville is a manufacturer of commercial roofing products and offers this general conceptual information to you as a courtesy. This complimentary assistance is not to be used or relied upon by anyone as a substitute for professional engineering design and documentation required by building code, contract, or applicable law. By accepting these comments you agree they do not constitute any representations, endorsements of, or an assumption by Johns Manville of any liability for either the adequacy of design of this building or any other material not supplied by Johns Manville.

Note: For the most current information on general guidelines, please refer to the System Considerations tab under Commercial Roofing Products on the JM Roofing Web site. For specifications, flashing details and general installation information please refer to the Application Tools tab.

Refer to the Safe Use Instructions and product label prior to using this product.



Through-Wall Scupper

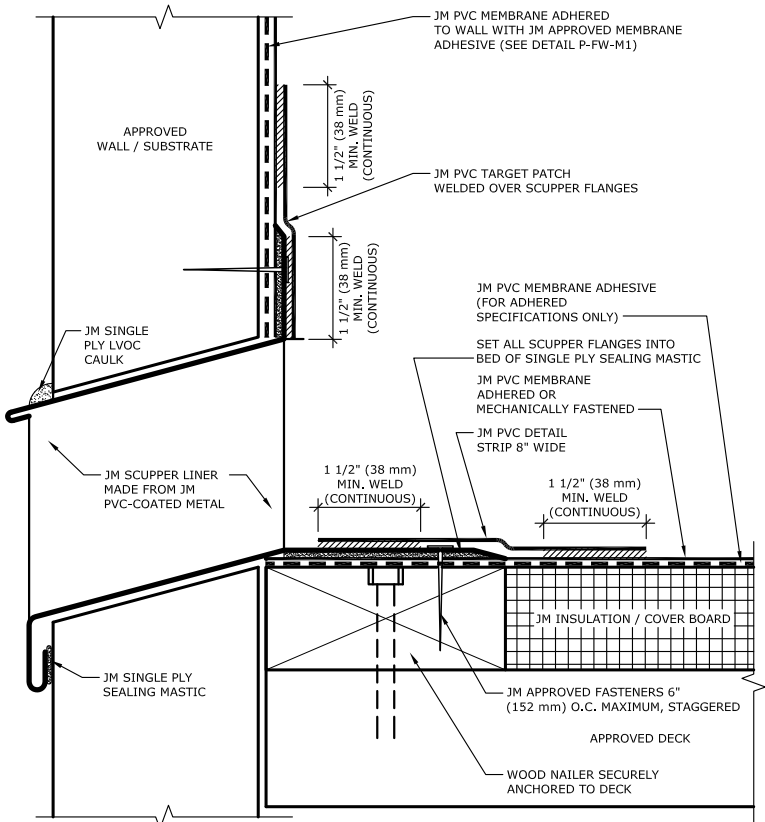

NOTES:

1. REFER TO JOHNS MANVILLE WEBSITE (www.Jm.com) FOR MOST UP-TO-DATE INFORMATION.
2. PLEASE SEE SINGLE PLY FLASHING SPECIFICATIONS FOR A FULL DESCRIPTION OF INSTALLATION INSTRUCTIONS AND REQUIREMENTS WHICH ARE CONSIDERED A PART OF THIS DETAIL.
3. ANY CARPENTRY OR METAL WORK SHOULD BE DESIGNED AND CONSTRUCTED IN ACCORDANCE WITH LOCAL CODE REQUIREMENTS AND/OR PROJECT SPECIFICATIONS. THESE COMPONENTS SHOULD BE REVIEWED AND APPROVED BY A LICENSED DESIGN PROFESSIONAL.
4. JM PVC EDGE SEALANT IS OPTIONAL ON ALL CUT OR NON-ENCAPSULATED EDGES OF REINFORCED MEMBRANE. THIS INCLUDES FACTORY CUT MEMBRANE (SEE DETAIL P-MS-01).

Maximum Guarantee Term: 30 Year

Johns Manville is a manufacturer of commercial roofing products and offers this general conceptual information to you as a courtesy. This complimentary assistance is not to be used or relied upon by anyone as a substitute for professional engineering design and documentation required by building code, contract, or applicable law. By accepting these comments you agree they do not constitute any representations, endorsements of, or an assumption by Johns Manville of any liability for either the adequacy of design of this building or any other material not supplied by Johns Manville.

Note: For the most current information on general guidelines, please refer to the System Considerations tab under Commercial Roofing Products on the JM Roofing Web site. For specifications, flashing details and general installation information please refer to the Application Tools tab.

Refer to the Safe Use Instructions and product label prior to using this product.



Through-Wall Scupper

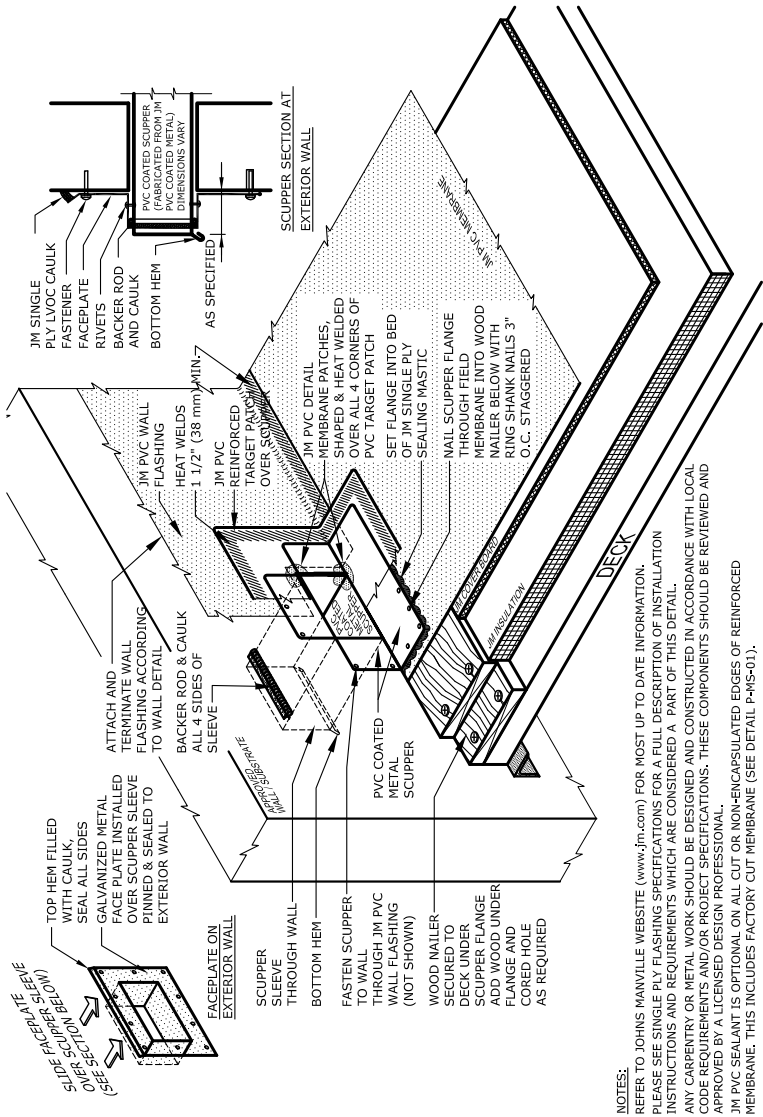

Maximum Guarantee Term: 30 Year

Johns Manville is a manufacturer of commercial roofing products and offers this general conceptual information to you as a courtesy. This complimentary assistance is not to be used or relied upon by anyone as a substitute for professional engineering design and documentation required by building code, contract, or applicable law. By accepting these comments you agree they do not constitute any representations, endorsements of, or an assumption by Johns Manville of any liability for either the adequacy of design of this building or any other material not supplied by Johns Manville.

Note: For the most current information on general guidelines, please refer to the System Considerations tab under Commercial Roofing Products on the JM Roofing Web site. For specifications, flashing details and general installation information please refer to the Application Tools tab.

Refer to the Safe Use Instructions and product label prior to using this product.



Primary Scupper With Tapered Insulation Sump

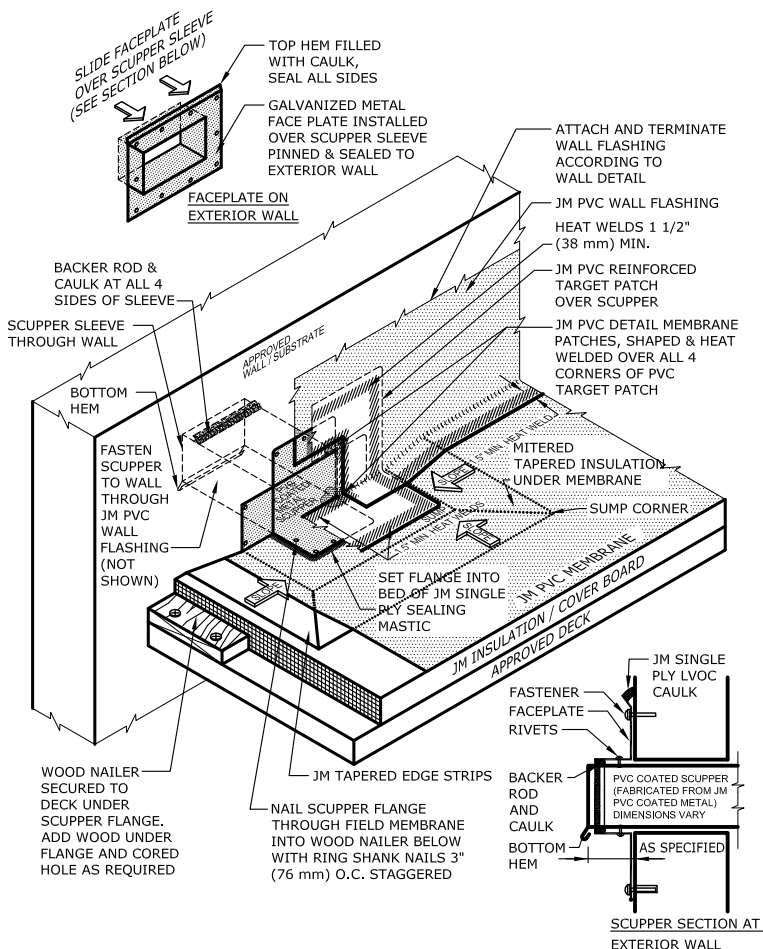

NOTES:

1. REFER TO JOHNS MANVILLE WEBSITE (www.jm.com) FOR MOST UP TO DATE INFORMATION.
2. PLEASE SEE SINGLE PLY FLASHING SPECIFICATIONS FOR A FULL DESCRIPTION OF INSTALLATION INSTRUCTIONS AND REQUIREMENTS WHICH ARE CONSIDERED A PART OF THIS DETAIL.
3. ANY CARPENTRY OR METAL WORK SHOULD BE DESIGNED AND CONSTRUCTED IN ACCORDANCE WITH LOCAL CODE REQUIREMENTS AND/OR PROJECT SPECIFICATIONS. THESE COMPONENTS SHOULD BE REVIEWED AND APPROVED BY A LICENSED DESIGN PROFESSIONAL.
4. JM PVC SEALANT IS OPTIONAL ON ALL CUT OR NON-ENCAPSULATED EDGES OF REINFORCED MEMBRANE. THIS INCLUDES FACTORY CUT MEMBRANE (SEE DETAIL P-MS-01).

Maximum Guarantee Term: 30 Year

Johns Manville is a manufacturer of commercial roofing products and offers this general conceptual information to you as a courtesy. This complimentary assistance is not to be used or relied upon by anyone as a substitute for professional engineering design and documentation required by building code, contract, or applicable law. By accepting these comments you agree they do not constitute any representations, endorsements of, or an assumption by Johns Manville of any liability for either the adequacy of design of this building or any other material not supplied by Johns Manville.

Note: For the most current information on general guidelines, please refer to the System Considerations tab under Commercial Roofing Products on the JM Roofing Web site. For specifications, flashing details and general installation information please refer to the Application Tools tab.

Refer to the Safe Use Instructions and product label prior to using this product.



Low-Wall Primary Scupper Flashing

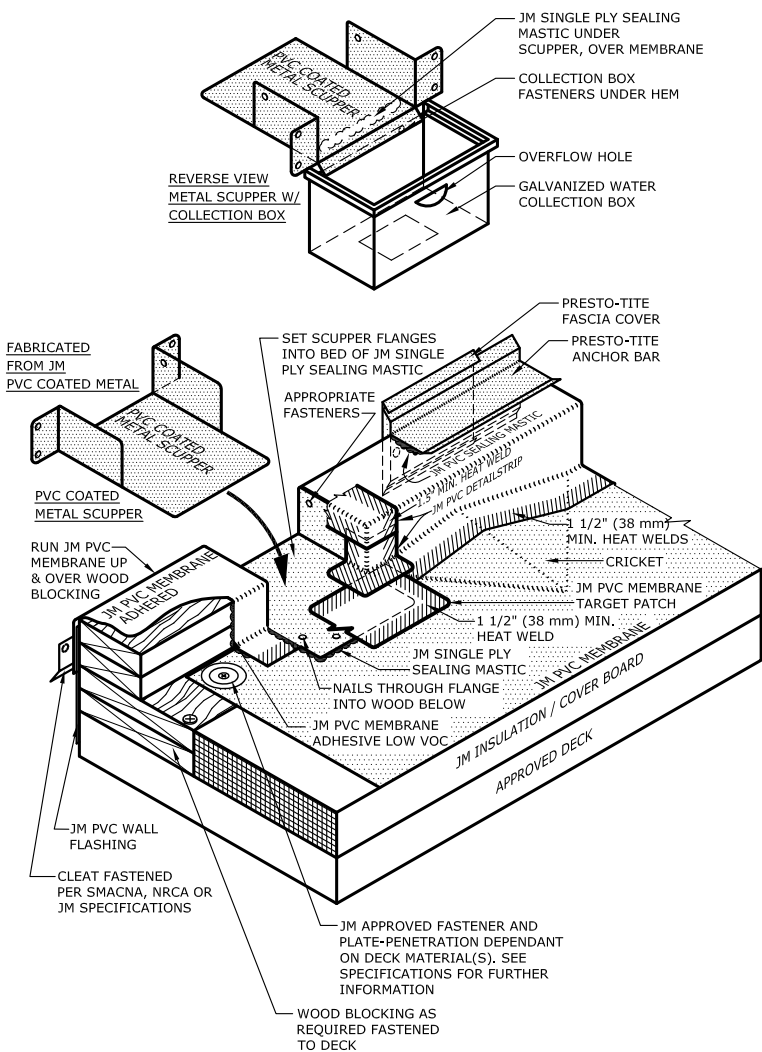

NOTES:

1. REFER TO JOHNS MANVILLE WEBSITE (www.jm.com) FOR MOST UP TO DATE INFORMATION.
2. PLEASE SEE SINGLE PLY FLASHING SPECIFICATIONS FOR A FULL DESCRIPTION OF INSTALLATION INSTRUCTIONS AND REQUIREMENTS WHICH ARE CONSIDERED A PART OF THIS DETAIL.
3. ANY CARPENTRY OR METAL WORK SHOULD BE DESIGNED AND CONSTRUCTED IN ACCORDANCE WITH LOCAL CODE REQUIREMENTS AND/OR PROJECT SPECIFICATIONS. THESE COMPONENTS SHOULD BE REVIEWED AND APPROVED BY A LICENSED DESIGN PROFESSIONAL.
4. JM PVC SEALANT IS OPTIONAL ON ALL CUT OR NON-ENCAPSULATED EDGES OF REINFORCED MEMBRANE. THIS INCLUDES FACTORY CUT MEMBRANE (SEE DETAIL P-MS-01).

Maximum Guarantee Term: 30 Year

Johns Manville is a manufacturer of commercial roofing products and offers this general conceptual information to you as a courtesy. This complimentary assistance is not to be used or relied upon by anyone as a substitute for professional engineering design and documentation required by building code, contract, or applicable law. By accepting these comments you agree they do not constitute any representations, endorsements of, or an assumption by Johns Manville of any liability for either the adequacy of design of this building or any other material not supplied by Johns Manville.

Note: For the most current information on general guidelines, please refer to the System Considerations tab under Commercial Roofing Products on the JM Roofing Web site. For specifications, flashing details and general installation information please refer to the Application Tools tab.

Refer to the Safe Use Instructions and product label prior to using this product.



Overflow Scupper

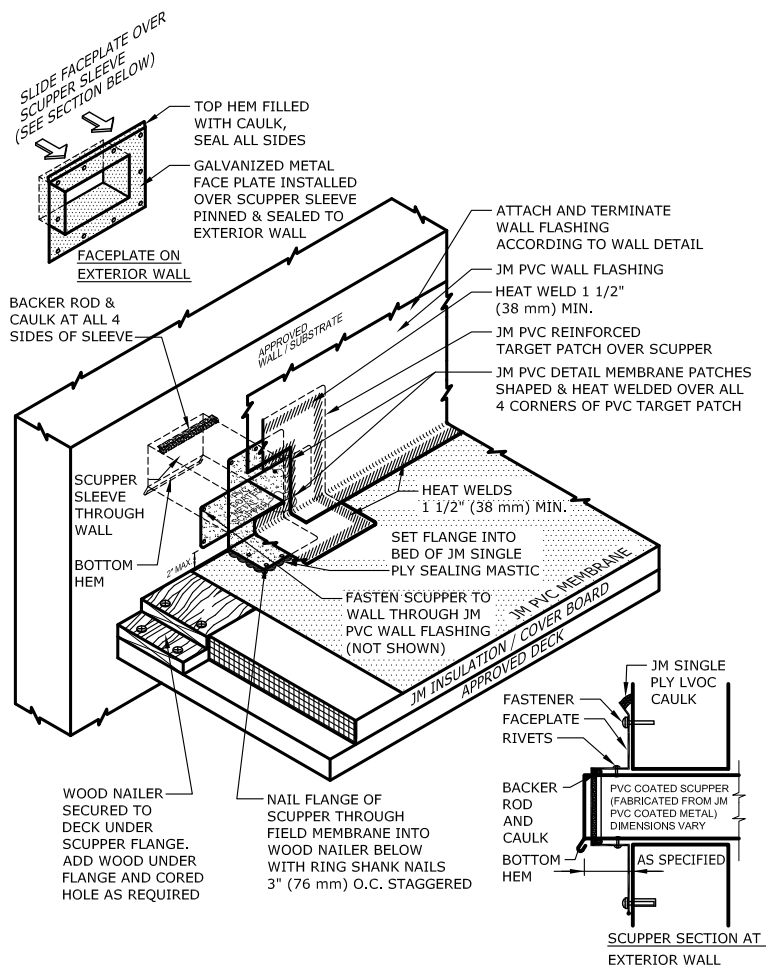

NOTES:

1. REFER TO JOHNS MANVILLE WEBSITE (www.jm.com) FOR MOST UP TO DATE INFORMATION.
2. PLEASE SEE SINGLE PLY FLASHING SPECIFICATIONS FOR A FULL DESCRIPTION OF INSTALLATION INSTRUCTIONS AND REQUIREMENTS WHICH ARE CONSIDERED A PART OF THIS DETAIL.
3. ANY CARPENTRY OR METAL WORK SHOULD BE DESIGNED AND CONSTRUCTED IN ACCORDANCE WITH LOCAL CODE REQUIREMENTS AND/OR PROJECT SPECIFICATIONS. THESE COMPONENTS SHOULD BE REVIEWED AND APPROVED BY A LICENSED DESIGN PROFESSIONAL.
4. JM PVC SEALANT IS OPTIONAL ON ALL CUT OR NON-ENCAPSULATED EDGES OF REINFORCED MEMBRANE. THIS INCLUDES FACTORY CUT MEMBRANE (SEE DETAIL P-MS-01).

Maximum Guarantee Term: 30 Year

Johns Manville is a manufacturer of commercial roofing products and offers this general conceptual information to you as a courtesy. This complimentary assistance is not to be used or relied upon by anyone as a substitute for professional engineering design and documentation required by building code, contract, or applicable law. By accepting these comments you agree they do not constitute any representations, endorsements of, or an assumption by Johns Manville of any liability for either the adequacy of design of this building or any other material not supplied by Johns Manville.

Note: For the most current information on general guidelines, please refer to the System Considerations tab under Commercial Roofing Products on the JM Roofing Web site. For specifications, flashing details and general installation information please refer to the Application Tools tab.

Refer to the Safe Use Instructions and product label prior to using this product.



Primary Drain Sump - Low Slope-Up To 3:12 Slope

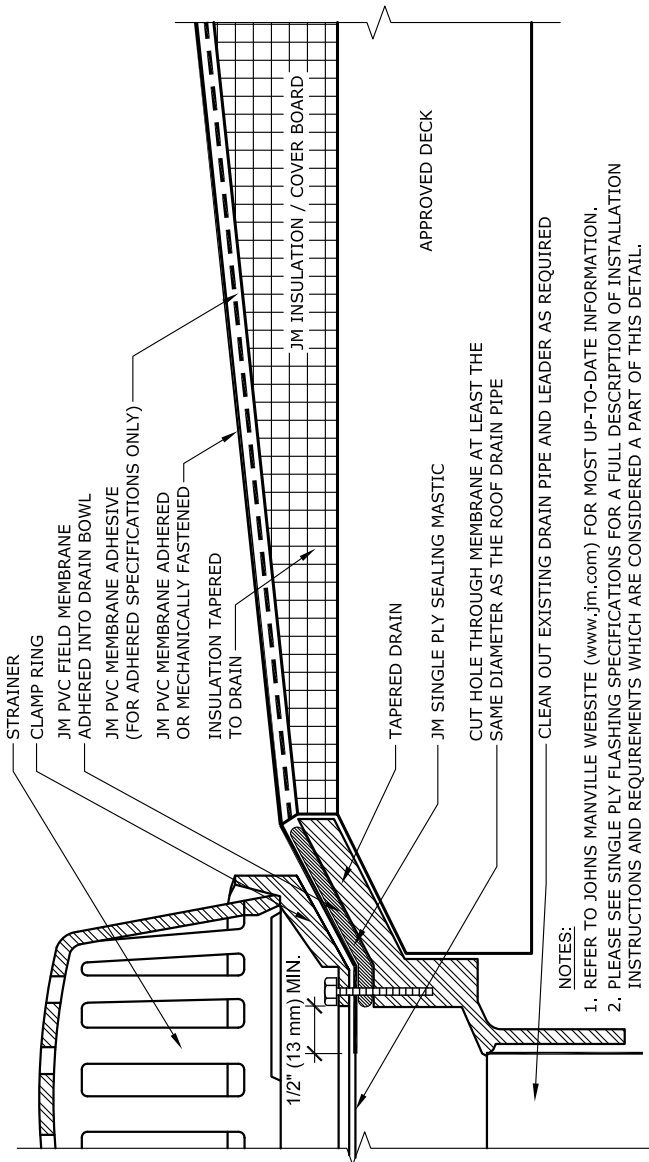

Maximum Guarantee Term: 30 Year

Johns Manville is a manufacturer of commercial roofing products and offers this general conceptual information to you as a courtesy. This complimentary assistance is not to be used or relied upon by anyone as a substitute for professional engineering design and documentation required by building code, contract, or applicable law. By accepting these comments you agree they do not constitute any representations, endorsements of, or an assumption by Johns Manville of any liability for either the adequacy of design of this building or any other material not supplied by Johns Manville.

Note: For the most current information on general guidelines, please refer to the System Considerations tab under Commercial Roofing Products on the JM Roofing Web site. For specifications, flashing details and general installation information please refer to the Application Tools tab.

Refer to the Safe Use Instructions and product label prior to using this product.



Primary Drain Sump - Steep Slope-Greater Than 3:12 Slope

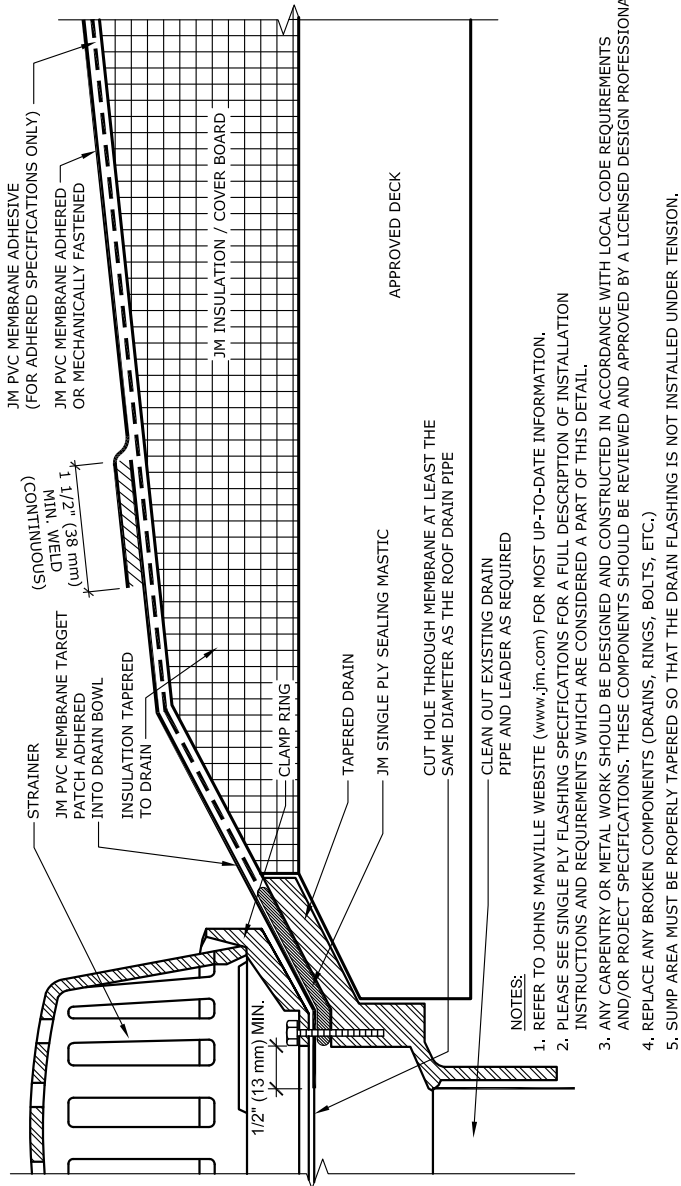

Maximum Guarantee Term: 30 Year

Johns Manville is a manufacturer of commercial roofing products and offers this general conceptual information to you as a courtesy. This complimentary assistance is not to be used or relied upon by anyone as a substitute for professional engineering design and documentation required by building code, contract, or applicable law. By accepting these comments you agree they do not constitute any representations, endorsements of, or an assumption by Johns Manville of any liability for either the adequacy of design of this building or any other material not supplied by Johns Manville.

Note: For the most current information on general guidelines, please refer to the System Considerations tab under Commercial Roofing Products on the JM Roofing Web site. For specifications, flashing details and general installation information please refer to the Application Tools tab.

Refer to the Safe Use Instructions and product label prior to using this product.



Primary Drain Sump - Fleece Backed Membrane

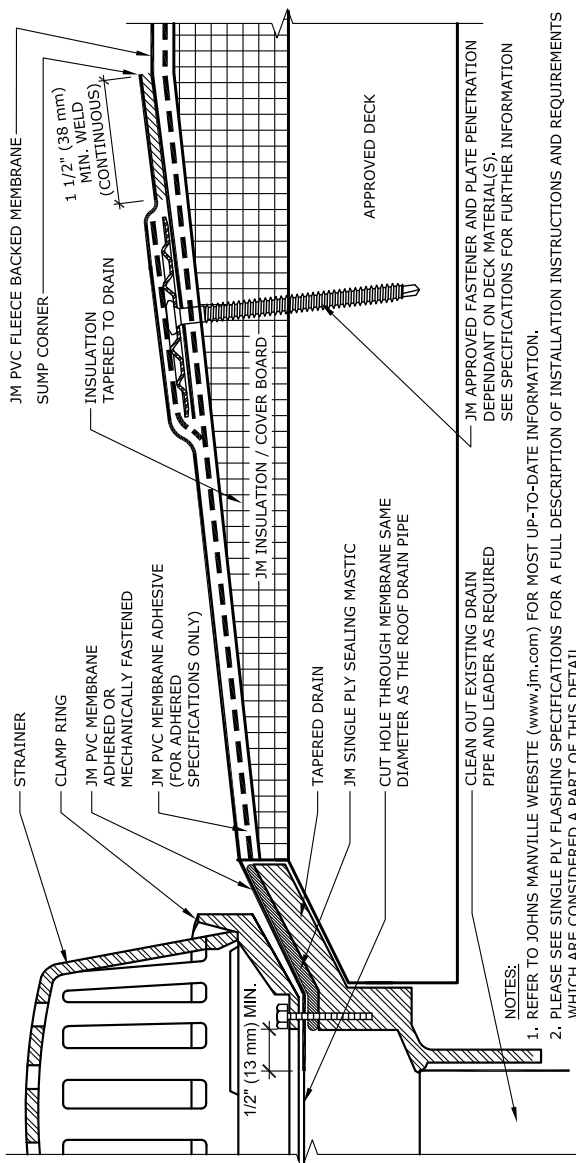

- NOTES:
1. REFER TO JOHNS MANVILLE WEBSITE (www.jm.com) FOR MOST UP-TO-DATE INFORMATION.
 2. PLEASE SEE SINGLE PLY FLASHING SPECIFICATIONS FOR A FULL DESCRIPTION OF INSTALLATION INSTRUCTIONS AND REQUIREMENTS WHICH ARE CONSIDERED A PART OF THIS DETAIL.
 3. ANY CARPENTRY OR METAL WORK SHOULD BE DESIGNED AND CONSTRUCTED IN ACCORDANCE WITH LOCAL CODE REQUIREMENTS AND/OR PROJECT SPECIFICATIONS. THESE COMPONENTS SHOULD BE REVIEWED AND APPROVED BY A LICENSED DESIGN PROFESSIONAL.
 4. REPLACE ANY BROKEN COMPONENTS (DRAINS, RINGS, BOLTS, ETC.)
 5. SUMP AREA MUST BE PROPERLY TAPERED SO THAT THE DRAIN FLASHING IS NOT INSTALLED UNDER TENSION.

Maximum Guarantee Term: 30 Year

Johns Manville is a manufacturer of commercial roofing products and offers this general conceptual information to you as a courtesy. This complimentary assistance is not to be used or relied upon by anyone as a substitute for professional engineering design and documentation required by building code, contract, or applicable law. By accepting these comments you agree they do not constitute any representations, endorsements of, or an assumption by Johns Manville of any liability for either the adequacy of design of this building or any other material not supplied by Johns Manville.

Note: For the most current information on general guidelines, please refer to the System Considerations tab under Commercial Roofing Products on the JM Roofing Web site. For specifications, flashing details and general installation information please refer to the Application Tools tab.

Refer to the Safe Use Instructions and product label prior to using this product.



PVC Fleece Backed Adhesive Applied Primary Drain In Sump

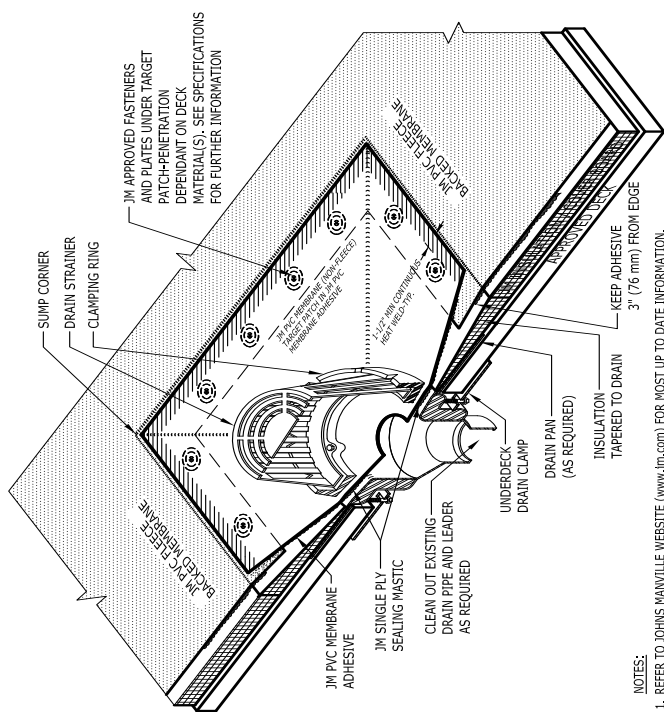

NOTES:

1. REFER TO JOHNS MANVILLE WEBSITE (www.jm.com) FOR MOST UP TO DATE INFORMATION.
2. PLEASE SEE SINGLE PLY FLASHING SPECIFICATIONS FOR A FULL DESCRIPTION OF INSTALLATION INSTRUCTIONS AND REQUIREMENTS WHICH ARE CONSIDERED A PART OF THIS DETAIL.
3. ANY CARPENTRY OR METAL WORK SHOULD BE DESIGNED AND CONSTRUCTED IN ACCORDANCE WITH LOCAL CODE REQUIREMENTS AND/OR PROJECT SPECIFICATIONS. THESE COMPONENTS SHOULD BE REVIEWED AND APPROVED BY A LICENSED DESIGN PROFESSIONAL.
4. JM PVC SEALANT IS OPTIONAL ON ALL CUT OR NON-ENCAPSULATED EDGES OF REINFORCED MEMBRANE. THIS INCLUDES FACTORY CUT MEMBRANE (SEE DETAIL P-MS).
5. SUMP AREA MUST BE PROPERLY TAPERED SO THAT THE DRAIN FLASHING IS NOT INSTALLED UNDER TENSION.

Maximum Guarantee Term: 30 Year

Johns Manville is a manufacturer of commercial roofing products and offers this general conceptual information to you as a courtesy. This complimentary assistance is not to be used or relied upon by anyone as a substitute for professional engineering design and documentation required by building code, contract, or applicable law. By accepting these comments you agree they do not constitute any representations, endorsements of, or an assumption by Johns Manville of any liability for either the adequacy of design of this building or any other material not supplied by Johns Manville.

Note: For the most current information on general guidelines, please refer to the System Considerations tab under Commercial Roofing Products on the JM Roofing Web site. For specifications, flashing details and general installation information please refer to the Application Tools tab.

Refer to the Safe Use Instructions and product label prior to using this product.



JM PVC Alumaweld Drain

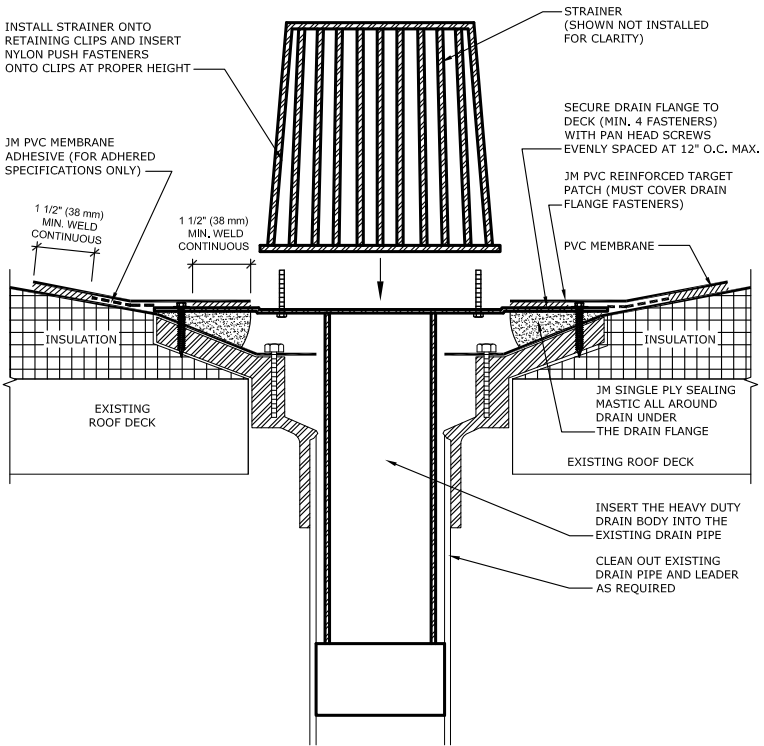

NOTES:

1. REFER TO JOHNS MANVILLE WEBSITE (www.jm.com) FOR MOST UP-TO-DATE INFORMATION.
2. PLEASE SEE SINGLE PLY FLASHING SPECIFICATIONS FOR A FULL DESCRIPTION OF INSTALLATION INSTRUCTIONS AND REQUIREMENTS WHICH ARE CONSIDERED A PART OF THIS DETAIL.
3. ANY CARPENTRY OR METAL WORK SHOULD BE DESIGNED AND CONSTRUCTED IN ACCORDANCE WITH LOCAL CODE REQUIREMENTS AND/OR PROJECT SPECIFICATIONS. THESE COMPONENTS SHOULD BE REVIEWED AND APPROVED BY A LICENSED DESIGN PROFESSIONAL.
4. REPLACE ANY BROKEN COMPONENTS (DRAINS, RINGS, BOLTS, ETC.)
5. SUMP AREA MUST BE PROPERLY TAPERED SO THAT THE DRAIN FLASHING IS NOT INSTALLED UNDER TENSION.

Maximum Guarantee Term: 20 Year

Johns Manville is a manufacturer of commercial roofing products and offers this general conceptual information to you as a courtesy. This complimentary assistance is not to be used or relied upon by anyone as a substitute for professional engineering design and documentation required by building code, contract, or applicable law. By accepting these comments you agree they do not constitute any representations, endorsements of, or an assumption by Johns Manville of any liability for either the adequacy of design of this building or any other material not supplied by Johns Manville.

Note: For the most current information on general guidelines, please refer to the System Considerations tab under Commercial Roofing Products on the JM Roofing Web site. For specifications, flashing details and general installation information please refer to the Application Tools tab.

Refer to the Safe Use Instructions and product label prior to using this product.



Primary Drain Sump - Mechanically Fastened Membrane

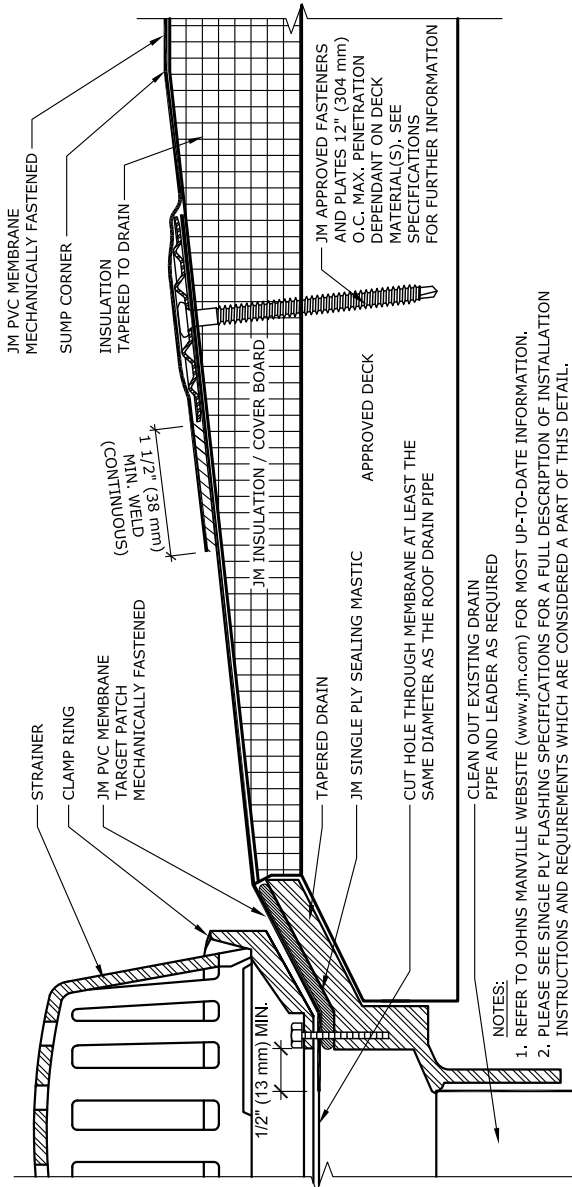

- NOTES:
1. REFER TO JOHNS MANVILLE WEBSITE (www.jm.com) FOR MOST UP-TO-DATE INFORMATION.
 2. PLEASE SEE SINGLE PLY FLASHING SPECIFICATIONS FOR A FULL DESCRIPTION OF INSTALLATION INSTRUCTIONS AND REQUIREMENTS WHICH ARE CONSIDERED A PART OF THIS DETAIL.
 3. ANY CARPENTRY OR METAL WORK SHOULD BE DESIGNED AND CONSTRUCTED IN ACCORDANCE WITH LOCAL CODE REQUIREMENTS AND/OR PROJECT SPECIFICATIONS. THESE COMPONENTS SHOULD BE REVIEWED AND APPROVED BY A LICENSED DESIGN PROFESSIONAL.
 4. JM PVC EDGE SEALANT IS OPTIONAL ON ALL CUT OR NON-ENCAPSULATED EDGES OF REINFORCED MEMBRANE. THIS INCLUDES FACTORY CUT MEMBRANE (SEE DETAIL P-MS-01).
 5. REPLACE ANY BROKEN COMPONENTS (DRAINS, RINGS, BOLTS, ETC.)
 6. SUMP AREA MUST BE PROPERLY TAPERED SO THAT THE DRAIN FLASHING IS NOT INSTALLED UNDER TENSION.

Maximum Guarantee Term: 30 Year

Johns Manville is a manufacturer of commercial roofing products and offers this general conceptual information to you as a courtesy. This complimentary assistance is not to be used or relied upon by anyone as a substitute for professional engineering design and documentation required by building code, contract, or applicable law. By accepting these comments you agree they do not constitute any representations, endorsements of, or an assumption by Johns Manville of any liability for either the adequacy of design of this building or any other material not supplied by Johns Manville.

Note: For the most current information on general guidelines, please refer to the System Considerations tab under Commercial Roofing Products on the JM Roofing Web site. For specifications, flashing details and general installation information please refer to the Application Tools tab.

Refer to the Safe Use Instructions and product label prior to using this product.



PVC Pipe Boot

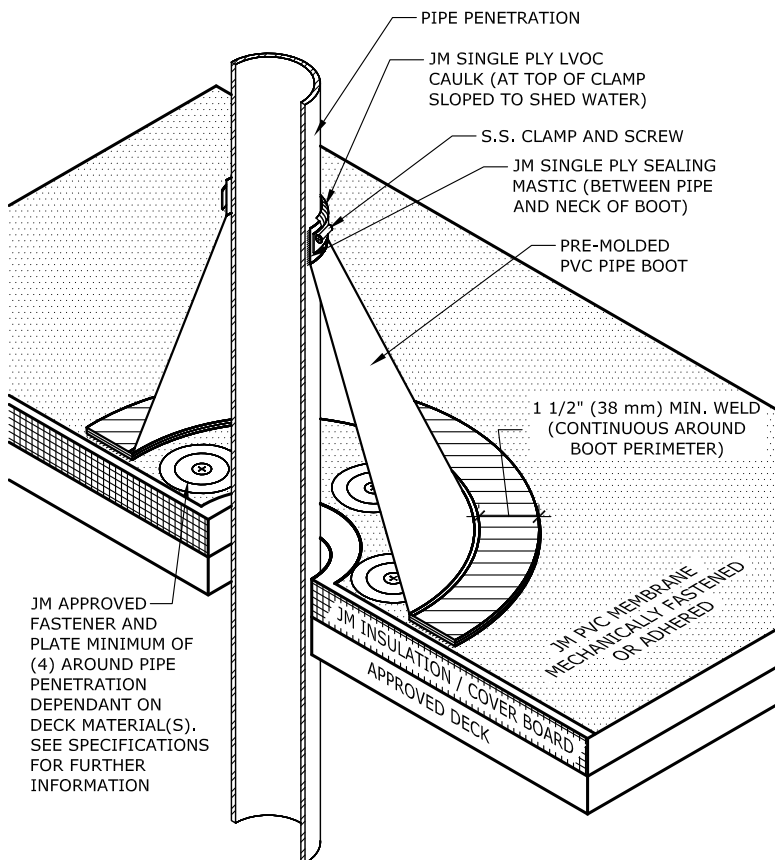

JM APPROVED FASTENER AND FASTENER AND PLATE MINIMUM OF (4) AROUND PIPE PENETRATION DEPENDANT ON DECK MATERIAL(S). SEE SPECIFICATIONS FOR FURTHER INFORMATION

NOTES:

1. REFER TO JOHNS MANVILLE WEBSITE (www.jm.com) FOR MOST UP TO DATE INFORMATION.
2. PLEASE SEE SINGLE PLY FLASHING SPECIFICATIONS FOR A FULL DESCRIPTION OF INSTALLATION INSTRUCTIONS AND REQUIREMENTS WHICH ARE CONSIDERED A PART OF THIS DETAIL.
3. ANY CARPENTRY OR METAL WORK SHOULD BE DESIGNED AND CONSTRUCTED IN ACCORDANCE WITH LOCAL CODE REQUIREMENTS AND/OR PROJECT SPECIFICATIONS. THESE COMPONENTS SHOULD BE REVIEWED AND APPROVED BY A LICENSED DESIGN PROFESSIONAL.
4. JM PVC SEALANT IS OPTIONAL ON ALL CUT OR NON-ENCAPSULATED EDGES OF REINFORCED MEMBRANE. THIS INCLUDES FACTORY CUT MEMBRANE (SEE DETAIL P-MS-01).

Maximum Guarantee Term: 30 Year

Johns Manville is a manufacturer of commercial roofing products and offers this general conceptual information to you as a courtesy. This complimentary assistance is not to be used or relied upon by anyone as a substitute for professional engineering design and documentation required by building code, contract, or applicable law. By accepting these comments you agree they do not constitute any representations, endorsements of, or an assumption by Johns Manville of any liability for either the adequacy of design of this building or any other material not supplied by Johns Manville.

Note: For the most current information on general guidelines, please refer to the System Considerations tab under Commercial Roofing Products on the JM Roofing Web site. For specifications, flashing details and general installation information please refer to the Application Tools tab.

Refer to the Safe Use Instructions and product label prior to using this product.



PVC Coated Metal Penetration Pocket

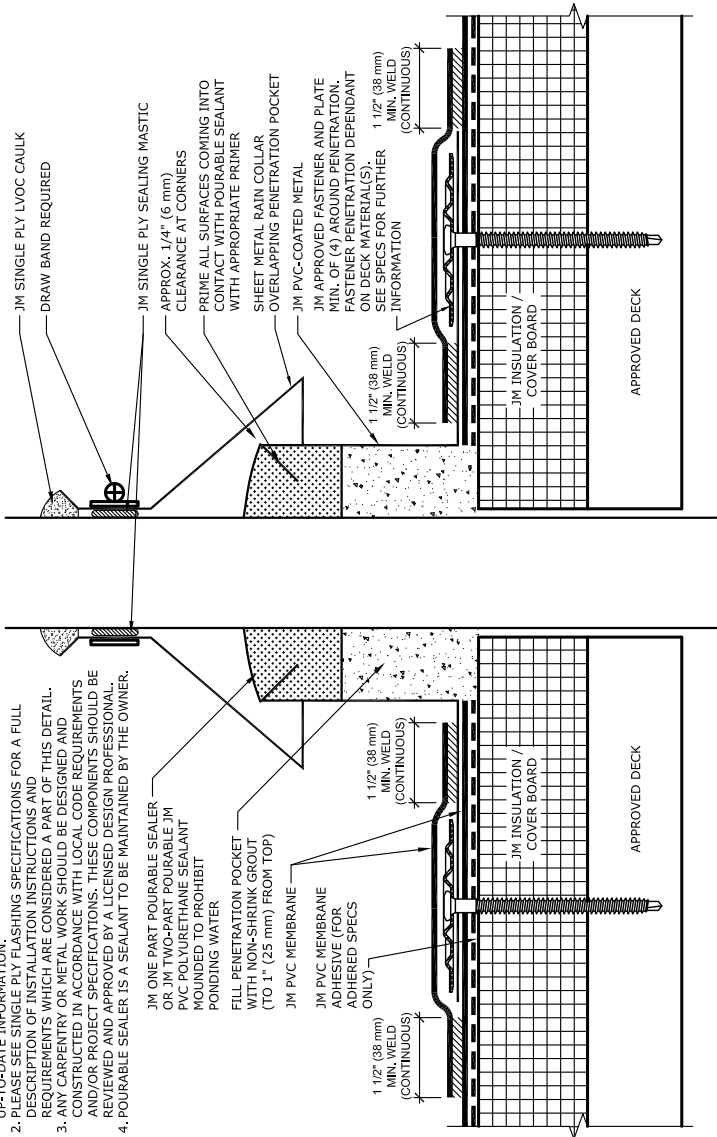

- NOTES:**
1. REFER TO JOHNS MANVILLE WEBSITE (www.jm.com) FOR MOST UP-TO-DATE INFORMATION.
 2. PLEASE SEE SINGLE PLY FLASHING SPECIFICATIONS AND DESCRIPTION OF INSTALLATION INSTRUCTIONS AND REQUIREMENTS WHICH ARE CONSIDERED A PART OF THIS DETAIL.
 3. ANY CARPENTRY OR METAL WORK SHOULD BE DESIGNED AND CONSTRUCTED IN ACCORDANCE WITH LOCAL CODE REQUIREMENTS AND/OR PROJECT SPECIFICATIONS. THESE COMPONENTS SHOULD BE REVIEWED AND APPROVED BY A LICENSED DESIGN PROFESSIONAL.
 4. POURABLE SEALER IS A SEALANT TO BE MAINTAINED BY THE OWNER.

- JM ONE PART POURABLE SEALER OR JM TWO-PART POURABLE JM PVC POLYURETHANE SEALANT MOUNDED TO PROHIBIT PONDING WATER
- FILL PENETRATION POCKET WITH NON-SHRINK GROUT (TO 1" (25 mm) FROM TOP)
- JM PVC MEMBRANE
- JM PVC MEMBRANE ADHESIVE (FOR ADHERED SPECS ONLY)
- 1 1/2" (38 mm) MIN. WELD (CONTINUOUS)
- 1 1/2" (38 mm) MIN. WELD (CONTINUOUS)
- JM INSULATION / COVER BOARD
- APPROVED DECK

Maximum Guarantee Term: 20 Year

Johns Manville is a manufacturer of commercial roofing products and offers this general conceptual information to you as a courtesy. This complimentary assistance is not to be used or relied upon by anyone as a substitute for professional engineering design and documentation required by building code, contract, or applicable law. By accepting these comments you agree they do not constitute any representations, endorsements, or an assumption by Johns Manville of any liability for either the adequacy of design of this building or any other material not supplied by Johns Manville.

Note: For the most current information on general guidelines, please refer to the System Considerations tab under Commercial Roofing Products on the JM Roofing Web site. For specifications, flashing details and general installation information please refer to the Application Tools tab.

Refer to the Safe Use Instructions and product label prior to using this product.



PVC Split Pipe Boot Round

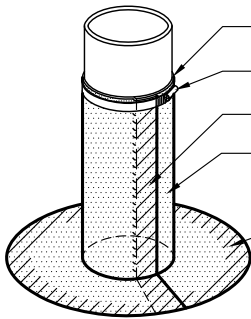

**INSTALLED BOOT
ISOMETRIC VIEW**

JM SINGLE PLY LVOC CAULK
(NOT SHOWN FOR CLARITY)
ADJUSTABLE METAL
STRAP (PROVIDED BY JM)
OVERLAP WELDED MIN.
1 1/2" (38 mm) CONTINUOUS
JM PVC ROUND SPLIT
PIPE BOOT FLASHING
WELD FLASHING BASE
TO FIELD MEMBRANE
MIN. 1 1/2" (38 mm)
CONTINUOUS

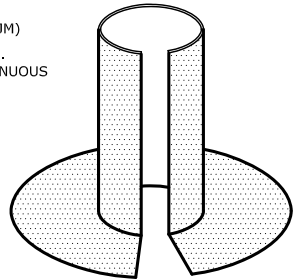

**UNINSTALLED BOOT
ISOMETRIC VIEW**

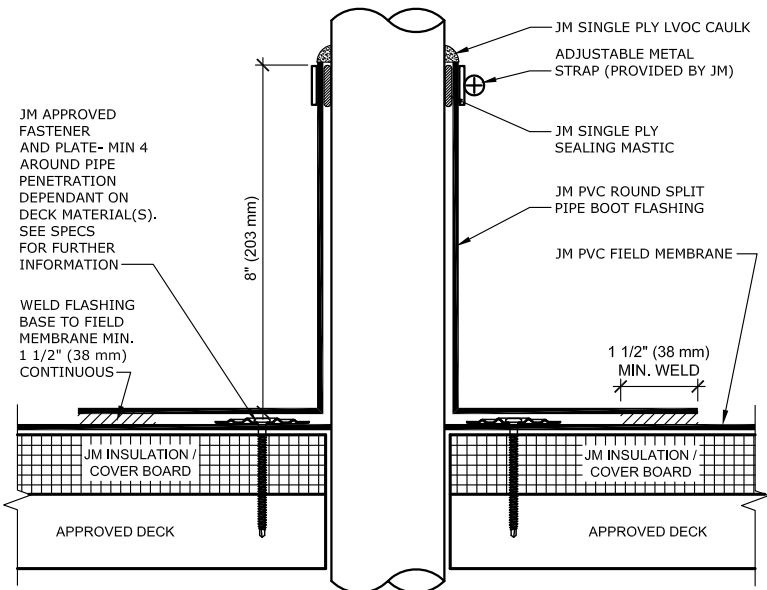

JM APPROVED
FASTENER
AND PLATE- MIN 4
AROUND PIPE
PENETRATION
DEPENDANT ON
DECK MATERIAL(S).
SEE SPECS
FOR FURTHER
INFORMATION

WELD FLASHING
BASE TO FIELD
MEMBRANE MIN.
1 1/2" (38 mm)
CONTINUOUS

NOTES:

1. REFER TO JOHNS MANVILLE WEBSITE (www.jm.com) FOR MOST UP-TO-DATE INFORMATION.
2. ANY CARPENTRY OR METAL WORK SHOULD BE DESIGNED AND CONSTRUCTED IN ACCORDANCE WITH LOCAL CODE REQUIREMENTS AND/OR PROJECT SPECIFICATIONS. THESE COMPONENTS SHOULD BE REVIEWED AND APPROVED BY A LICENSED DESIGN PROFESSIONAL.
3. STANDARD JM ROUND SPLIT PIPE BOOT SIZES ARE 1", 2", 3", 4", 5" & 6".

Maximum Guarantee Term: 20 Year

Johns Manville is a manufacturer of commercial roofing products and offers this general conceptual information to you as a courtesy. This complimentary assistance is not to be used or relied upon by anyone as a substitute for professional engineering design and documentation required by building code, contract, or applicable law. By accepting these comments you agree they do not constitute any representations, endorsements of, or an assumption by Johns Manville of any liability for either the adequacy of design of this building or any other material not supplied by Johns Manville.

Note: For the most current information on general guidelines, please refer to the System Considerations tab under Commercial Roofing Products on the JM Roofing Web site. For specifications, flashing details and general installation information please refer to the Application Tools tab.

Refer to the Safe Use Instructions and product label prior to using this product.



PVC Split Pipe Boot - Square-Clamped

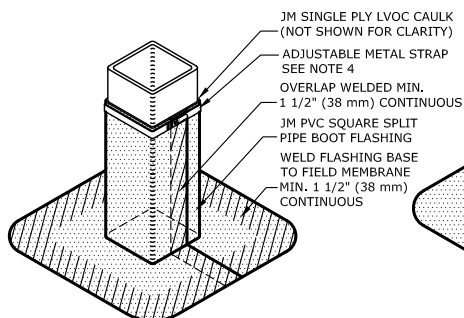

**INSTALLED BOOT
ISOMETRIC VIEW**

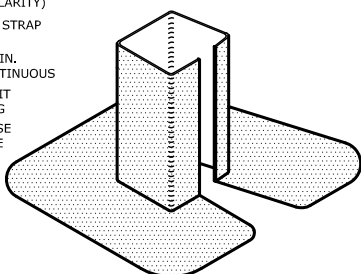

**UNINSTALLED BOOT
ISOMETRIC VIEW**

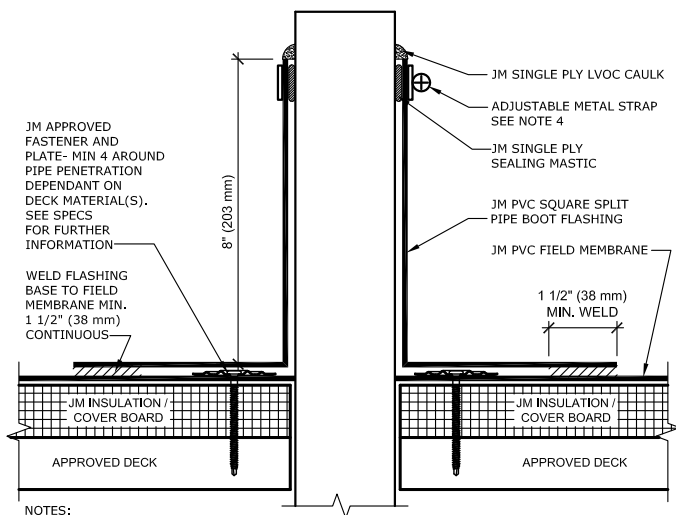

NOTES:

1. REFER TO JOHNS MANVILLE WEBSITE (www.jm.com) FOR MOST UP-TO-DATE INFORMATION.
2. ANY CARPENTRY OR METAL WORK SHOULD BE DESIGNED AND CONSTRUCTED IN ACCORDANCE WITH LOCAL CODE REQUIREMENTS AND/OR PROJECT SPECIFICATIONS. THESE COMPONENTS SHOULD BE REVIEWED AND APPROVED BY A LICENSED DESIGN PROFESSIONAL.
3. STANDARD JM SQUARE SPLIT PIPE BOOT SIZES ARE 2" AND 4".
4. HOLD CLAMP ADJUSTMENT SCREW AT CENTER OF SIDE OF TUBING, 1/8" DOWN FROM TOP OF FLASHING. TIGHTLY FORM STRAP AROUND 90 DEGREE CORNER AND REPEAT FOR OTHER 3 CORNERS WHILE KEEPING STRAP TIGHT. FEED STRAP END INTO ADJUSTMENT SCREW AND TIGHTEN. ENSURE 1/8" OF FLASHING IS EXPOSED ABOVE STRAP, AND SEALING MASTIC BEHIND FLASHING IS EXPOSED ABOVE FLASHING. CAULK TOP OF FLASHING AROUND ENTIRE PIPE.

Maximum Guarantee Term: 20 Year

Johns Manville is a manufacturer of commercial roofing products and offers this general conceptual information to you as a courtesy. This complimentary assistance is not to be used or relied upon by anyone as a substitute for professional engineering design and documentation required by building code, contract, or applicable law. By accepting these comments you agree they do not constitute any representations, endorsements of, or an assumption by Johns Manville of any liability for either the adequacy of design of this building or any other material not supplied by Johns Manville.

Note: For the most current information on general guidelines, please refer to the System Considerations tab under Commercial Roofing Products on the JM Roofing Web site. For specifications, flashing details and general installation information please refer to the Application Tools tab.

Refer to the Safe Use Instructions and product label prior to using this product.



PVC Split Pipe Boot - Square

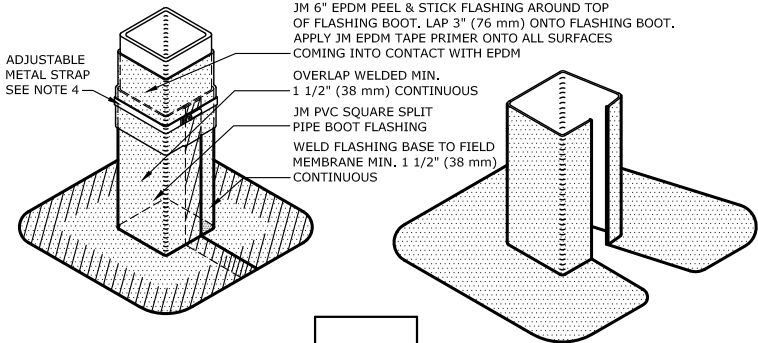

**INSTALLED BOOT
ISOMETRIC VIEW**

**UNINSTALLED BOOT
ISOMETRIC VIEW**

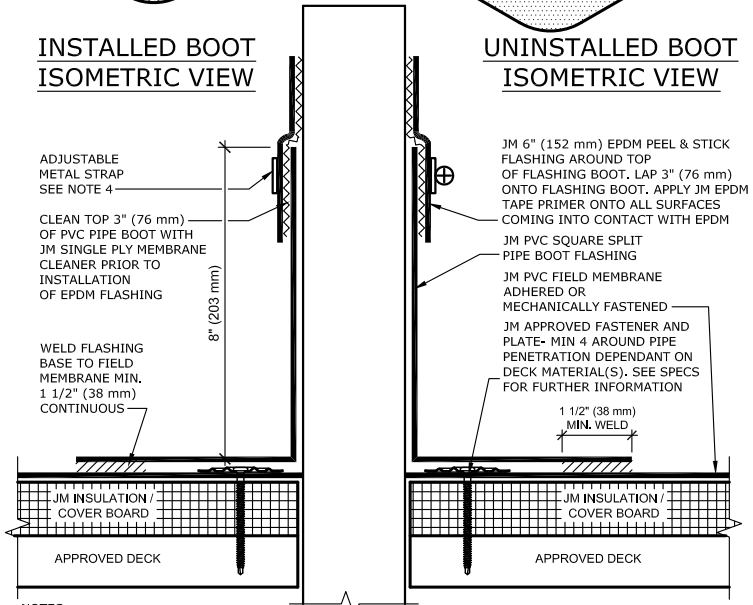

NOTES:

- REFER TO JOHNS MANVILLE WEBSITE (www.jm.com) FOR MOST UP-TO-DATE INFORMATION.
- ANY CARPENTRY OR METAL WORK SHOULD BE DESIGNED AND CONSTRUCTED IN ACCORDANCE WITH LOCAL CODE REQUIREMENTS AND/OR PROJECT SPECIFICATIONS. THESE COMPONENTS SHOULD BE REVIEWED AND APPROVED BY A LICENSED DESIGN PROFESSIONAL.
- STANDARD JM SQUARE SPLIT PIPE BOOT SIZES ARE 2" AND 4".
- HOLD CLAMP ADJUSTMENT SCREW AT CENTER OF SIDE OF TUBING, 1/8" DOWN FROM TOP OF FLASHING. TIGHTLY FORM STRAP AROUND 90 DEGREE CORNER AND REPEAT FOR OTHER 3 CORNERS WHILE KEEPING STRAP TIGHT. FEED STRAP END INTO ADJUSTMENT SCREW AND TIGHTEN. ENSURE 1/8" OF FLASHING IS EXPOSED ABOVE STRAP, AND SEALING MASTIC BEHIND FLASHING IS EXPOSED ABOVE FLASHING. CAULK TOP OF FLASHING AROUND ENTIRE PIPE.

Maximum Guarantee Term: 20 Year

Johns Manville is a manufacturer of commercial roofing products and offers this general conceptual information to you as a courtesy. This complimentary assistance is not to be used or relied upon by anyone as a substitute for professional engineering design and documentation required by building code, contract, or applicable law. By accepting these comments you agree they do not constitute any representations, endorsements of, or an assumption by Johns Manville of any liability for either the adequacy of design of this building or any other material not supplied by Johns Manville.

Note: For the most current information on general guidelines, please refer to the System Considerations tab under Commercial Roofing Products on the JM Roofing Web site. For specifications, flashing details and general installation information please refer to the Application Tools tab.

Refer to the Safe Use Instructions and product label prior to using this product.



Field Fabricated Pipe Penetration

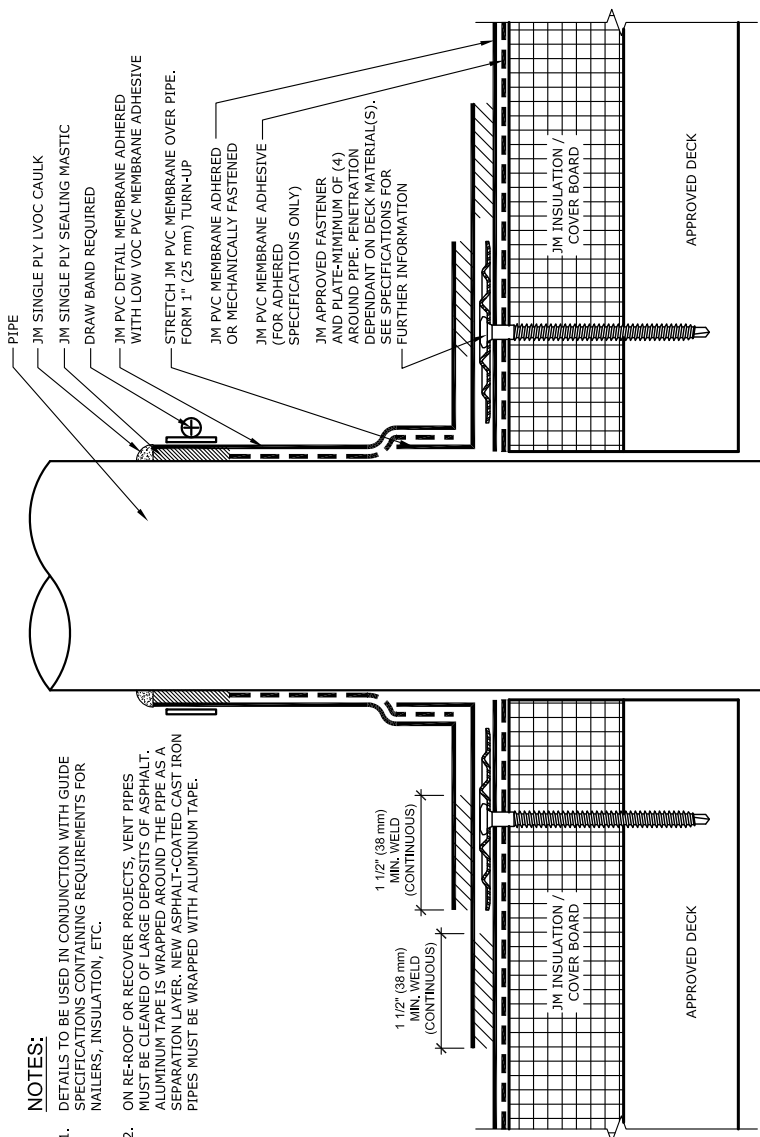

Maximum Guarantee Term: 20 Year

Johns Manville is a manufacturer of commercial roofing products and offers this general conceptual information to you as a courtesy. This complimentary assistance is not to be used or relied upon by anyone as a substitute for professional engineering design and documentation required by building code, contract, or applicable law. By accepting these comments you agree they do not constitute any representations, endorsements of, or an assumption by Johns Manville of any liability for either the adequacy of design of this building or any other material not supplied by Johns Manville.

Note: For the most current information on general guidelines, please refer to the System Considerations tab under Commercial Roofing Products on the JM Roofing Web site. For specifications, flashing details and general installation information please refer to the Application Tools tab.

Refer to the Safe Use Instructions and product label prior to using this product.



JM PVC Penetration Pan

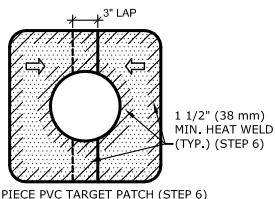
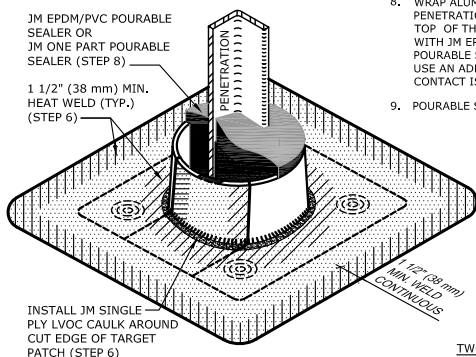
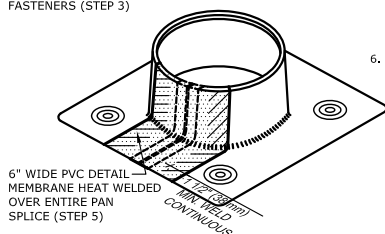
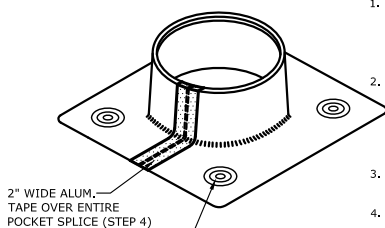

- INSTALLATION STEPS:**
1. USING A WIRE BRUSH OR GRINDER, CLEAN PENETRATION DOWN TO BARE METAL FROM JUST BELOW THE MEMBRANE SURFACE TO JUST ABOVE THE TOP OF THE JM PVC PENETRATION PAN TO ALLOW GOOD ADHESION BETWEEN THE PENETRATION AND THE JM EPDM/PVC POURABLE SEALER.
 2. RADIUS ALL CORNERS OF THE JM PVC PENETRATION PAN. IT IS RECOMMENDED TO CLEAN THE INSIDE OF THE JM PVC PENETRATION PAN WITH JM SINGLE PLY MEMBRANE CLEANER (LVOC). PLACE THE JM PVC PENETRATION PAN AROUND THE PENETRATION, NESTING THE SPLICED SECTION OF THE POCKET TOGETHER.
 3. FASTEN THE JM PVC PENETRATION PAN TO THE ROOF DECK USING FOUR APPROPRIATE FASTENERS AND PLATES.
 4. INSTALL 2" WIDE ALUMINUM TAPE CENTERED OVER THE ENTIRE SPLICE AND TURN DOWN INSIDE THE PAN.
 5. HEAT WELD A 6" WIDE PIECE OF JM PVC DETAIL MEMBRANE, MIN. 1 1/2" WIDE WELD, CENTERED OVER THE JM PVC PENETRATION PAN SPLICE THE FULL LENGTH OF THE SPLICE, AND TURN DOWN 1" INTO THE PAN AND WELD INSIDE TO THE INTERIOR WALL OF THE PAN.
 6. CUT A 18" X 18" TARGET PATCH OF PVC MEMBRANE AND RADIUS ALL CORNERS. CUT A HOLE IN THE CENTER OF THE TARGET PATCH 1/2" LARGER THAN THE BOTTOM DIAMETER OF THE JM PVC PENETRATION PAN. HEAT WELD THE TARGET PATCH AROUND THE ENTIRE OPENING TO THE JM PVC PENETRATION PAN, AND THE OUTER EDGES OF THE PATCH TO THE FIELD MEMBRANE WITH MIN. 1 1/2" WELD. INSTALL A BEAD OF JM SINGLE PLY LVOC CAULK AROUND THE ENTIRE HOLE CUT EDGE OF THE PVC TARGET PATCH. FOR A PENETRATION THAT IS OBSTRUCTED FROM ABOVE PREVENTING A ONE PIECE TARGET PATCH INSTALLATION, CUT A 18" X 24" PVC TARGET PATCH, CUT IN HALF AND OVERLAP THE EDGES BY 3" AND HEAT WELD AS STATED ABOVE, AND THE CUT EDGE LAPS MIN. 1 1/2" WELD.
 7. USING A SEAM PROBE, CHECK ALL WELDS FOR VOIDS AND MAKE NECESSARY REPAIRS.
 8. WRAP ALUMINUM TAPE AROUND THE TOP OF THE JM PVC PENETRATION PAN WITH 1" STICKING UP ABOVE THE TOP OF THE POCKET. FILL THE POCKET ABOVE THE TOP WITH JM EPDM/PVC POURABLE SEALER OR JM ONE PART POURABLE SEALER, MOUNDING TO PROHIBIT PONDING WATER. USE AN ADEQUATE AMOUNT OF SEALANT TO ENSURE PROPER CONTACT IS MADE WITH THE TOP RIM OF THE PAN.
 9. POURABLE SEALER IS TO BE MAINTAINED BY THE OWNER.

Maximum Guarantee Term: 20 Year

Johns Manville is a manufacturer of commercial roofing products and offers this general conceptual information to you as a courtesy. This complimentary assistance is not to be used or relied upon by anyone as a substitute for professional engineering design and documentation required by building code, contract, or applicable law. By accepting these comments you agree they do not constitute any representations, endorsements of, or an assumption by Johns Manville of any liability for either the adequacy of design of this building or any other material not supplied by Johns Manville.

Note: For the most current information on general guidelines, please refer to the System Considerations tab under Commercial Roofing Products on the JM Roofing Web site. For specifications, flashing details and general installation information please refer to the Application Tools tab.

Refer to the Safe Use Instructions and product label prior to using this product.



Transition For Staged Roofing - PVC Coated Metal

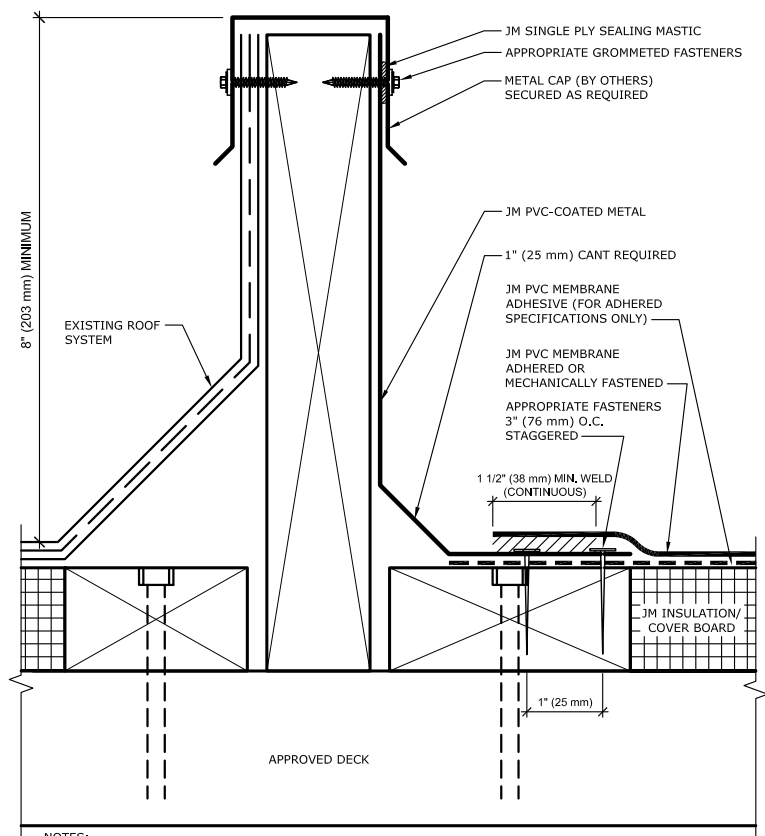

NOTES:

1. REFER TO JOHNS MANVILLE WEBSITE (www.jm.com) FOR MOST UP-TO-DATE INFORMATION.
2. PLEASE SEE SINGLE PLY FLASHING SPECIFICATIONS FOR A FULL DESCRIPTION OF INSTALLATION INSTRUCTIONS AND REQUIREMENTS WHICH ARE CONSIDERED A PART OF THIS DETAIL.
3. ANY CARPENTRY OR METAL WORK SHOULD BE DESIGNED AND CONSTRUCTED IN ACCORDANCE WITH LOCAL CODE REQUIREMENTS AND/OR PROJECT SPECIFICATIONS. THESE COMPONENTS SHOULD BE REVIEWED AND APPROVED BY A LICENSED DESIGN PROFESSIONAL.

Maximum Guarantee Term: 20 Year

Johns Manville is a manufacturer of commercial roofing products and offers this general conceptual information to you as a courtesy. This complimentary assistance is not to be used or relied upon by anyone as a substitute for professional engineering design and documentation required by building code, contract, or applicable law. By accepting these comments you agree they do not constitute any representations, endorsements of, or an assumption by Johns Manville of any liability for either the adequacy of design of this building or any other material not supplied by Johns Manville.

Note: For the most current information on general guidelines, please refer to the System Considerations tab under Commercial Roofing Products on the JM Roofing Web site. For specifications, flashing details and general installation information please refer to the Application Tools tab.

Refer to the Safe Use Instructions and product label prior to using this product.



Transition To Shingle Roof With PVC Coated Metal

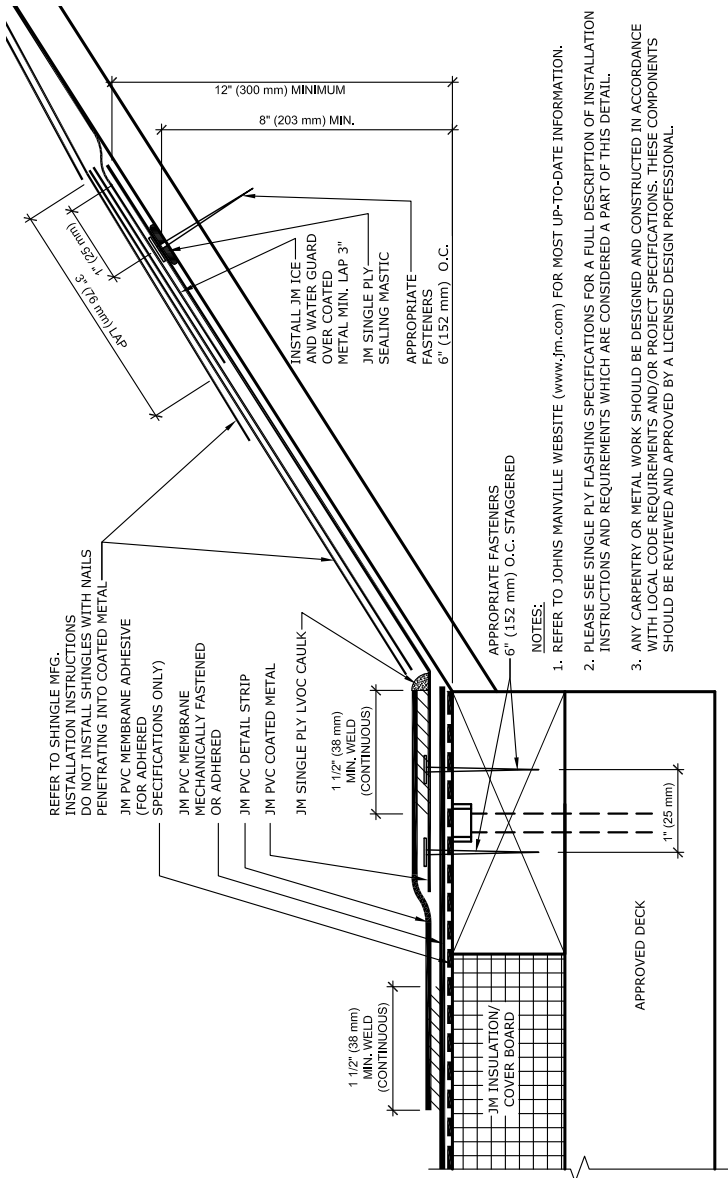

Maximum Guarantee Term: 20 Year

Johns Manville is a manufacturer of commercial roofing products and offers this general conceptual information to you as a courtesy. This complimentary assistance is not to be used or relied upon by anyone as a substitute for professional engineering design and documentation required by building code, contract, or applicable law. By accepting these comments you agree they do not constitute any representations, endorsements of, or an assumption by Johns Manville of any liability for either the adequacy of design of this building or any other material not supplied by Johns Manville.

Note: For the most current information on general guidelines, please refer to the System Considerations tab under Commercial Roofing Products on the JM Roofing Web site. For specifications, flashing details and general installation information please refer to the Application Tools tab.

Refer to the Safe Use Instructions and product label prior to using this product.



Curb Tie-In To Roof By Others

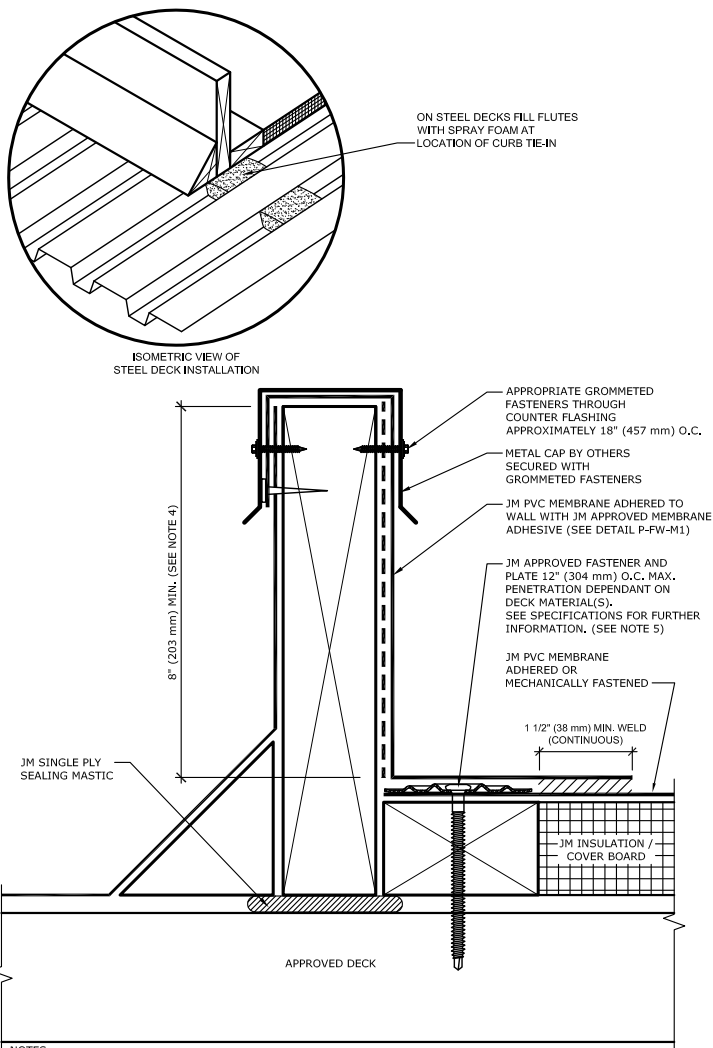

NOTES:

1. REFER TO JOHNS MANVILLE WEBSITE (www.jm.com) FOR MOST UP-TO-DATE INFORMATION.
2. PLEASE SEE SINGLE PLY FLASHING SPECIFICATIONS FOR A FULL DESCRIPTION OF INSTALLATION INSTRUCTIONS AND REQUIREMENTS WHICH ARE CONSIDERED A PART OF THIS DETAIL.
3. ANY CARPENTRY OR METAL WORK SHOULD BE DESIGNED AND CONSTRUCTED IN ACCORDANCE WITH LOCAL CODE REQUIREMENTS AND/OR PROJECT SPECIFICATIONS. THESE COMPONENTS SHOULD BE REVIEWED AND APPROVED BY A LICENSED DESIGN PROFESSIONAL.
4. HEIGHT OF CURB TO BE ADJUSTED WITH NAILERS. IT IS PREFERRED TO RAISE CURB ONTO NAILERS TO EXTEND FLASHING HEIGHT.
5. SEE P-FW-B DETAILS FOR JM APPROVED BASE FLASHING TIE IN TERMINATION METHODS.

Maximum Guarantee Term: 30 Year

Johns Manville is a manufacturer of commercial roofing products and offers this general conceptual information to you as a courtesy. This complimentary assistance is not to be used or relied upon by anyone as a substitute for professional engineering design and documentation required by building code, contract, or applicable law. By accepting these comments you agree they do not constitute any representations, endorsements of, or an assumption by Johns Manville of any liability for either the adequacy of design of this building or any other material not supplied by Johns Manville.

Note: For the most current information on general guidelines, please refer to the System Considerations tab under Commercial Roofing Products on the JM Roofing Web site. For specifications, flashing details and general installation information please refer to the Application Tools tab.

Refer to the Safe Use Instructions and product label prior to using this product.



Expansion Joint - Roof To Wall

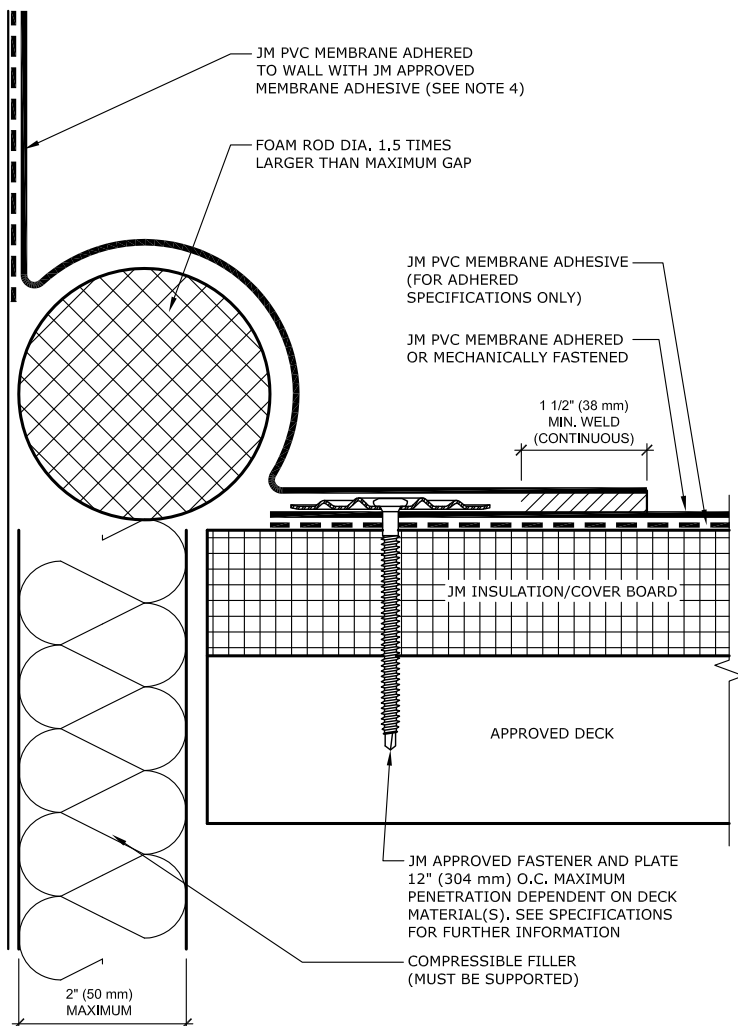

NOTES:

1. REFER TO JOHNS MANVILLE WEBSITE (www.jm.com) FOR MOST UP-TO-DATE INFORMATION.
2. PLEASE SEE SINGLE PLY FLASHING SPECIFICATIONS FOR A FULL DESCRIPTION OF INSTALLATION INSTRUCTIONS AND REQUIREMENTS WHICH ARE CONSIDERED A PART OF THIS DETAIL.
3. ANY CARPENTRY OR METAL WORK SHOULD BE DESIGNED AND CONSTRUCTED IN ACCORDANCE WITH LOCAL CODE REQUIREMENTS AND/OR PROJECT SPECIFICATIONS, THESE COMPONENTS SHOULD BE REVIEWED AND APPROVED BY A LICENSED DESIGN PROFESSIONAL.
4. JM APPROVED ADHESIVES OR USE ON VERTICAL FLASHING APPLICATIONS INCLUDED JM PVC MEMBRANE ADHESIVES (LOW VOC ONLY).

Maximum Guarantee Term: 30 Year

Johns Manville is a manufacturer of commercial roofing products and offers this general conceptual information to you as a courtesy. This complimentary assistance is not to be used or relied upon by anyone as a substitute for professional engineering design and documentation required by building code, contract, or applicable law. By accepting these comments you agree they do not constitute any representations, endorsements of, or an assumption by Johns Manville of any liability for either the adequacy of design of this building or any other material not supplied by Johns Manville.

Note: For the most current information on general guidelines, please refer to the System Considerations tab under Commercial Roofing Products on the JM Roofing Web site. For specifications, flashing details and general installation information please refer to the Application Tools tab.

Refer to the Safe Use Instructions and product label prior to using this product.



Expansion Joint - Roof To Roof

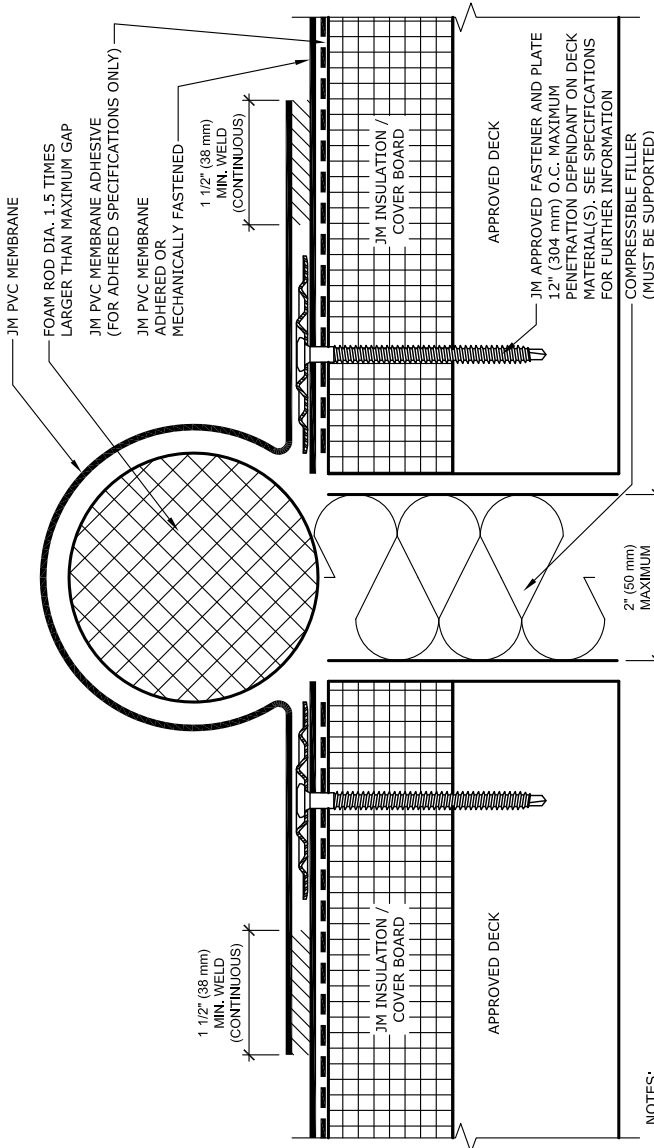

Maximum Guarantee Term: 30 Year

Johns Manville is a manufacturer of commercial roofing products and offers this general conceptual information to you as a courtesy. This complimentary assistance is not to be used or relied upon by anyone as a substitute for professional engineering design and documentation required by building code, contract, or applicable law. By accepting these comments you agree they do not constitute any representations, endorsements of, or an assumption by Johns Manville of any liability for either the adequacy of design of this building or any other material not supplied by Johns Manville.

Note: For the most current information on general guidelines, please refer to the System Considerations tab under Commercial Roofing Products on the JM Roofing Web site. For specifications, flashing details and general installation information please refer to the Application Tools tab.

Refer to the Safe Use Instructions and product label prior to using this product.



Expand-O-Flash Roof To Roof Expansion Joint Cover - Style EJ/WC

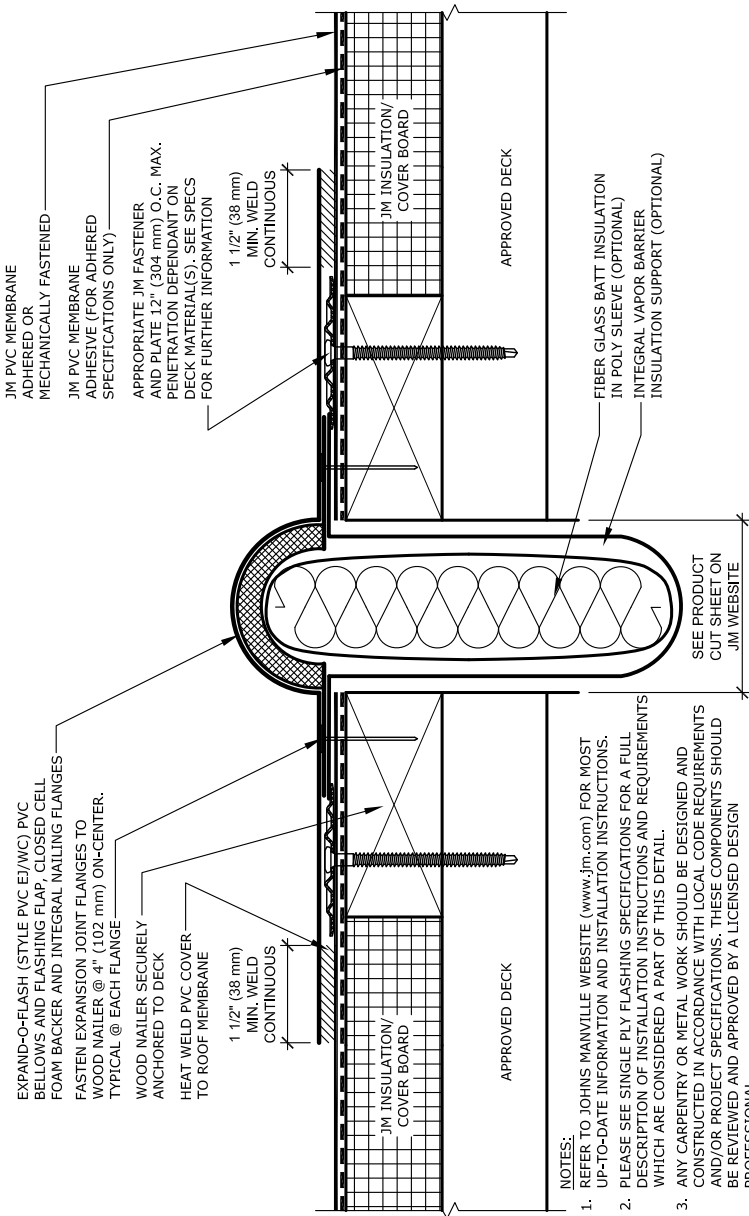

Maximum Guarantee Term: 20 Year

Johns Manville is a manufacturer of commercial roofing products and offers this general conceptual information to you as a courtesy. This complimentary assistance is not to be used or relied upon by anyone as a substitute for professional engineering design and documentation required by building code, contract, or applicable law. By accepting these comments you agree they do not constitute any representations, endorsements of, or an assumption by Johns Manville of any liability for either the adequacy of design of this building or any other material not supplied by Johns Manville.

Note: For the most current information on general guidelines, please refer to the System Considerations tab under Commercial Roofing Products on the JM Roofing Web site. For specifications, flashing details and general installation information please refer to the Application Tools tab.

Refer to the Safe Use Instructions and product label prior to using this product.



Expand-O-Flash Roof To Wall - Style EJ/WC

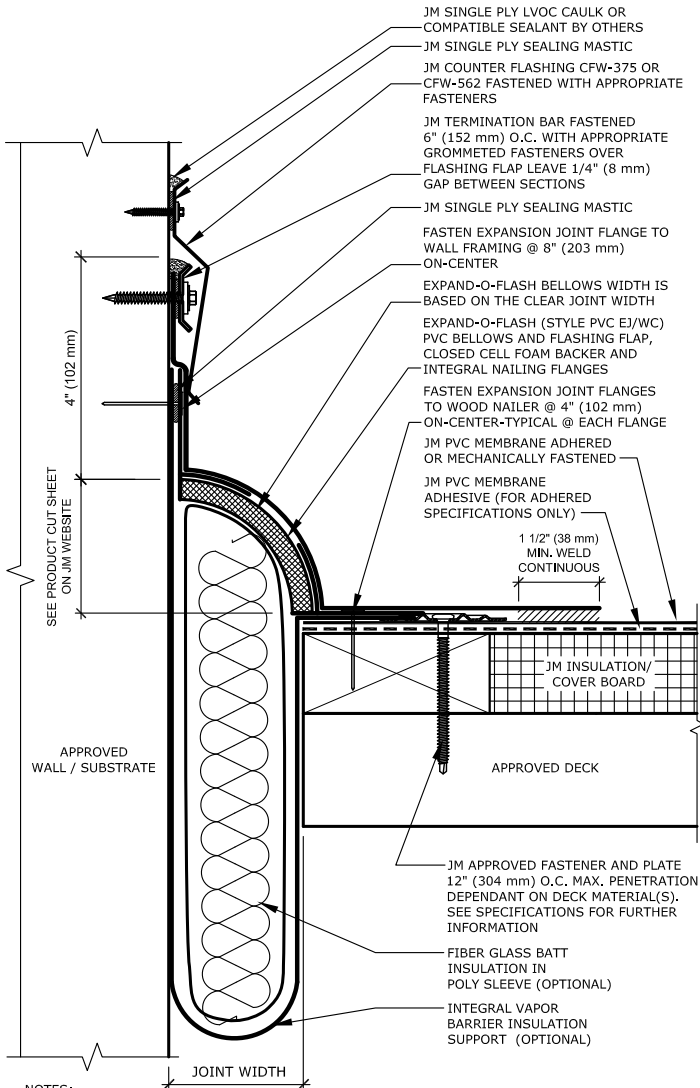

NOTES:

1. REFER TO JOHNS MANVILLE WEBSITE (www.jm.com) FOR MOST UP-TO-DATE INFORMATION AND INSTALLATION INSTRUCTIONS.
2. PLEASE SEE SINGLE PLY FLASHING SPECIFICATIONS FOR A FULL DESCRIPTION OF INSTALLATION INSTRUCTIONS AND REQUIREMENTS WHICH ARE CONSIDERED A PART OF THIS DETAIL.
3. ANY CARPENTRY OR METAL WORK SHOULD BE DESIGNED AND CONSTRUCTED IN ACCORDANCE WITH LOCAL CODE REQUIREMENTS AND/OR PROJECT SPECIFICATIONS. THESE COMPONENTS SHOULD BE REVIEWED AND APPROVED BY A LICENSED DESIGN PROFESSIONAL.

Maximum Guarantee Term: 20 Year

Johns Manville is a manufacturer of commercial roofing products and offers this general conceptual information to you as a courtesy. This complimentary assistance is not to be used or relied upon by anyone as a substitute for professional engineering design and documentation required by building code, contract, or applicable law. By accepting these comments you agree they do not constitute any representations, endorsements of, or an assumption by Johns Manville of any liability for either the adequacy of design of this building or any other material not supplied by Johns Manville.

Note: For the most current information on general guidelines, please refer to the System Considerations tab under Commercial Roofing Products on the JM Roofing Web site. For specifications, flashing details and general installation information please refer to the Application Tools tab.

Refer to the Safe Use Instructions and product label prior to using this product.



Expand-O-Flash Curb To Curb Expansion Joint Cover - Style CF

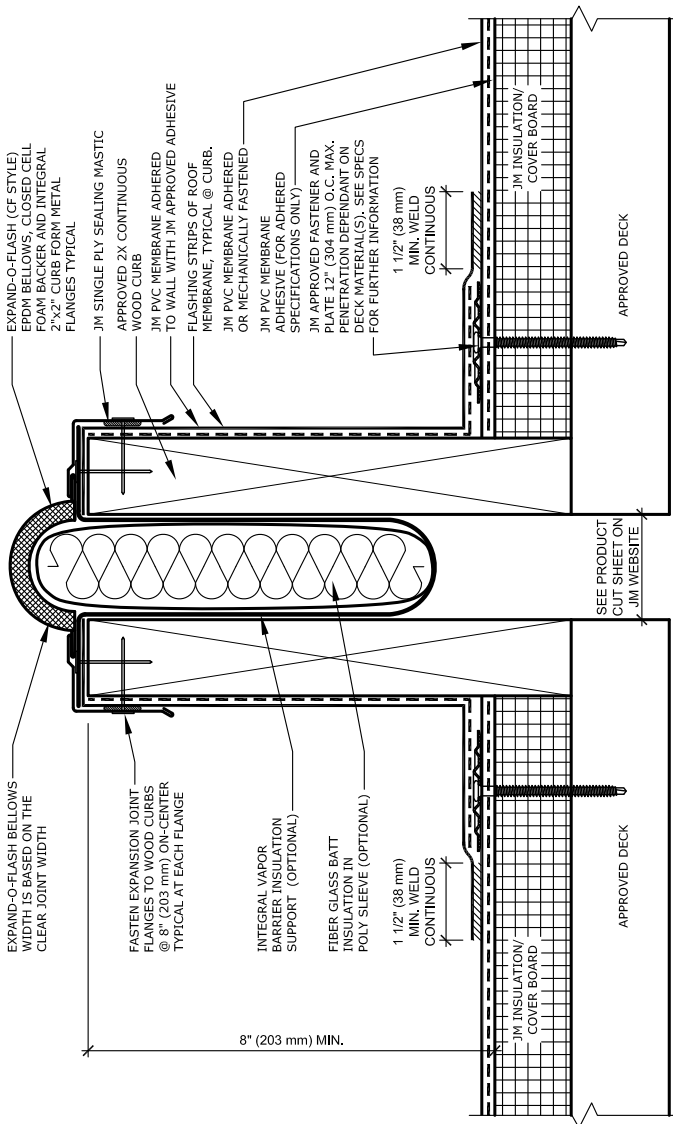

- NOTES:
1. REFER TO JOHNS MANVILLE WEBSITE (www.jm.com) FOR MOST UP-TO-DATE INFORMATION AND INSTALLATION INSTRUCTIONS.
 2. PLEASE SEE SINGLE PLY FLASHING SPECIFICATIONS FOR A FULL DESCRIPTION OF INSTALLATION INSTRUCTIONS AND REQUIREMENTS WHICH ARE CONSIDERED A PART OF THIS DETAIL.
 3. ANY CARPENTRY OR METAL WORK SHOULD BE DESIGNED AND CONSTRUCTED IN ACCORDANCE WITH LOCAL CODE REQUIREMENTS AND/OR PROJECT SPECIFICATIONS. THESE COMPONENTS SHOULD BE REVIEWED AND APPROVED BY A LICENSED DESIGN PROFESSIONAL.

Maximum Guarantee Term: 20 Year

Johns Manville is a manufacturer of commercial roofing products and offers this general conceptual information to you as a courtesy. This complimentary assistance is not to be used or relied upon by anyone as a substitute for professional engineering design and documentation required by building code, contract, or applicable law. By accepting these comments you agree they do not constitute any representations, endorsements of, or an assumption by Johns Manville of any liability for either the adequacy of design of this building or any other material not supplied by Johns Manville.

Note: For the most current information on general guidelines, please refer to the System Considerations tab under Commercial Roofing Products on the JM Roofing Web site. For specifications, flashing details and general installation information please refer to the Application Tools tab.

Refer to the Safe Use Instructions and product label prior to using this product.



Expand-O-Flash Curb To Wall Expansion Joint Cover - Style CF/EJ

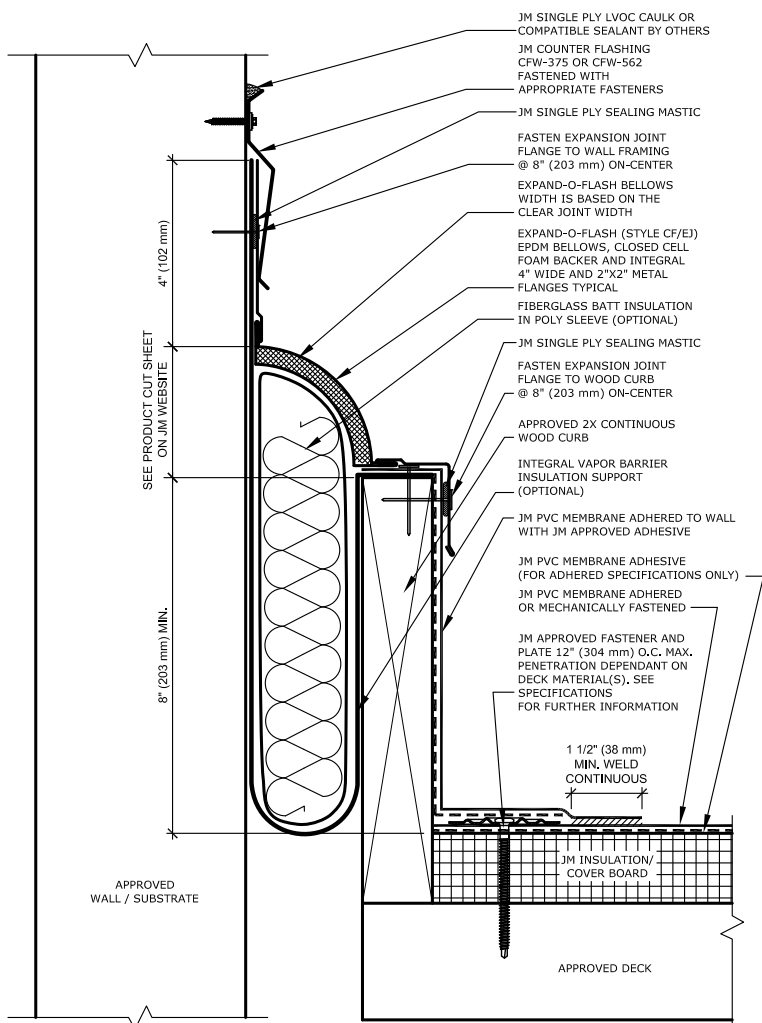

NOTES:

1. REFER TO JOHNS MANVILLE WEBSITE (www.Jm.com) FOR MOST UP-TO-DATE INFORMATION AND INSTALLATION INSTRUCTIONS.
2. PLEASE SEE SINGLE PLY FLASHING SPECIFICATIONS FOR A FULL DESCRIPTION OF INSTALLATION INSTRUCTIONS AND REQUIREMENTS WHICH ARE CONSIDERED A PART OF THIS DETAIL.
3. ANY CARPENTRY OR METAL WORK SHOULD BE DESIGNED AND CONSTRUCTED IN ACCORDANCE WITH LOCAL CODE REQUIREMENTS AND/OR PROJECT SPECIFICATIONS. THESE COMPONENTS SHOULD BE REVIEWED AND APPROVED BY A LICENSED DESIGN PROFESSIONAL.

Maximum Guarantee Term: 10 Year

Johns Manville is a manufacturer of commercial roofing products and offers this general conceptual information to you as a courtesy. This complimentary assistance is not to be used or relied upon by anyone as a substitute for professional engineering design and documentation required by building code, contract, or applicable law. By accepting these comments you agree they do not constitute any representations, endorsements of, or an assumption by Johns Manville of any liability for either the adequacy of design of this building or any other material not supplied by Johns Manville.

Note: For the most current information on general guidelines, please refer to the System Considerations tab under Commercial Roofing Products on the JM Roofing Web site. For specifications, flashing details and general installation information please refer to the Application Tools tab.

Refer to the Safe Use Instructions and product label prior to using this product.



Expand-O-Flash Curb To Wall Expansion Joint Cover - Style EJ/WC

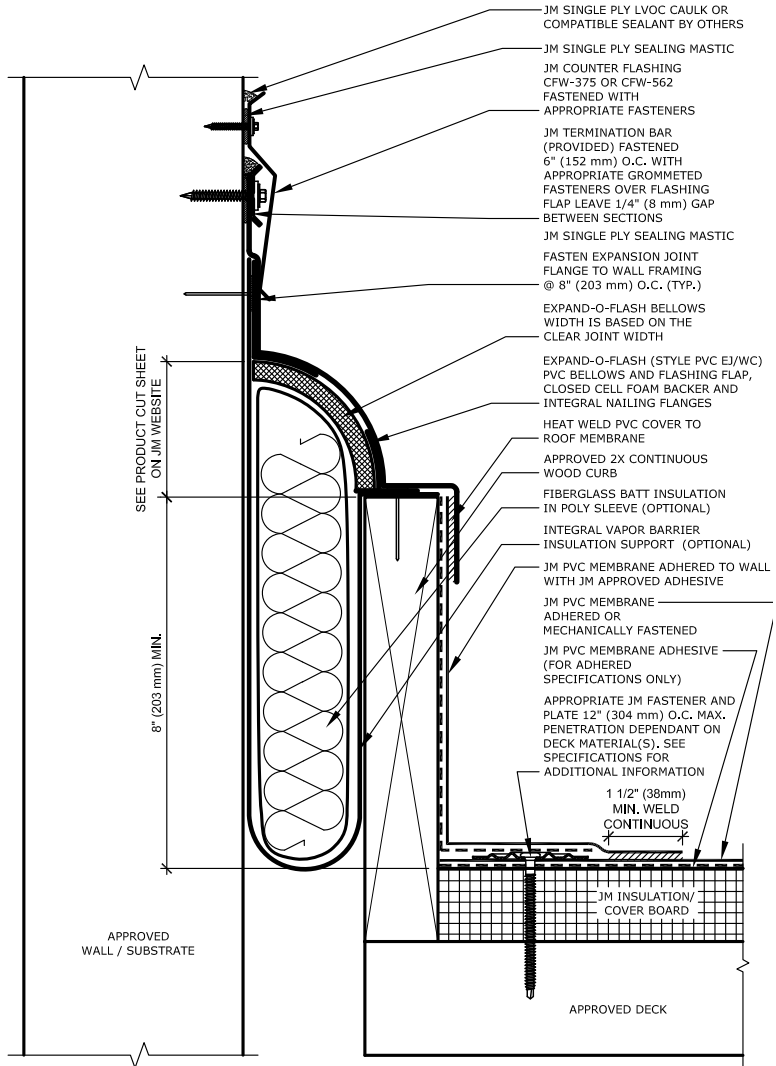

- NOTES:**
1. REFER TO JOHNS MANVILLE WEBSITE (www.Jm.com) FOR MOST UP-TO-DATE INFORMATION AND INSTALLATION INSTRUCTIONS
 2. PLEASE SEE SINGLE PLY FLASHING SPECIFICATIONS FOR A FULL DESCRIPTION OF INSTALLATION INSTRUCTIONS AND REQUIREMENTS WHICH ARE CONSIDERED A PART OF THIS DETAIL.
 3. ANY CARPENTRY OR METAL WORK SHOULD BE DESIGNED AND CONSTRUCTED IN ACCORDANCE WITH LOCAL CODE REQUIREMENTS AND/OR PROJECT SPECIFICATIONS. THESE COMPONENTS SHOULD BE REVIEWED AND APPROVED BY A LICENSED DESIGN PROFESSIONAL

Maximum Guarantee Term: 20 Year

Johns Manville is a manufacturer of commercial roofing products and offers this general conceptual information to you as a courtesy. This complimentary assistance is not to be used or relied upon by anyone as a substitute for professional engineering design and documentation required by building code, contract, or applicable law. By accepting these comments you agree they do not constitute any representations, endorsements of, or an assumption by Johns Manville of any liability for either the adequacy of design of this building or any other material not supplied by Johns Manville.

Note: For the most current information on general guidelines, please refer to the System Considerations tab under Commercial Roofing Products on the JM Roofing Web site. For specifications, flashing details and general installation information please refer to the Application Tools tab.

Refer to the Safe Use Instructions and product label prior to using this product.



Expand-O-Flash Curb To Curb Expansion Joint Cover - Style EJ/WC

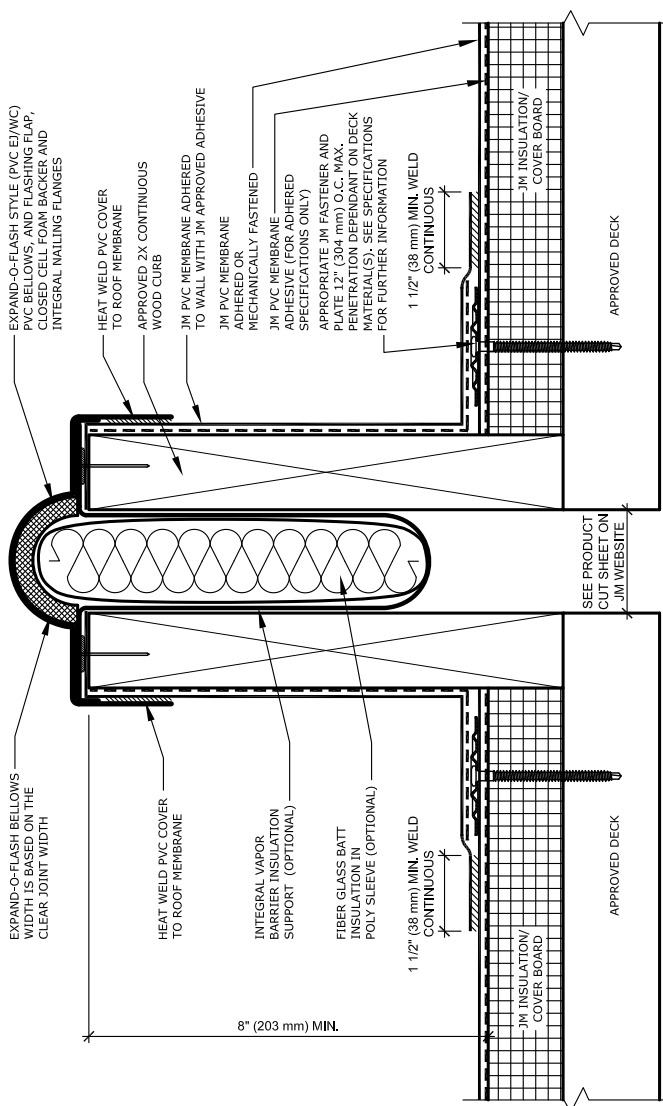

- NOTES:
1. REFER TO JOHNS MANVILLE WEBSITE (www.jm.com) FOR MOST UP-TO-DATE INFORMATION AND INSTALLATION INSTRUCTIONS.
 2. PLEASE SEE SINGLE PLY FLASHING SPECIFICATIONS FOR A FULL DESCRIPTION OF INSTALLATION INSTRUCTIONS AND REQUIREMENTS WHICH ARE CONSIDERED A PART OF THIS DETAIL.
 3. ANY CARPENTRY OR METAL WORK SHOULD BE DESIGNED AND CONSTRUCTED IN ACCORDANCE WITH LOCAL CODE REQUIREMENTS AND/OR PROJECT SPECIFICATIONS. THESE COMPONENTS SHOULD BE REVIEWED AND APPROVED BY A LICENSED DESIGN PROFESSIONAL.

Maximum Guarantee Term: 20 Year

Johns Manville is a manufacturer of commercial roofing products and offers this general conceptual information to you as a courtesy. This complimentary assistance is not to be used or relied upon by anyone as a substitute for professional engineering design and documentation required by building code, contract, or applicable law. By accepting these comments you agree they do not constitute any representations, endorsements of, or an assumption by Johns Manville of any liability for either the adequacy of design of this building or any other material not supplied by Johns Manville.

Note: For the most current information on general guidelines, please refer to the System Considerations tab under Commercial Roofing Products on the JM Roofing Web site. For specifications, flashing details and general installation information please refer to the Application Tools tab.

Refer to the Safe Use Instructions and product label prior to using this product.



JM Vapor Barrier SA - Wall Base Detail

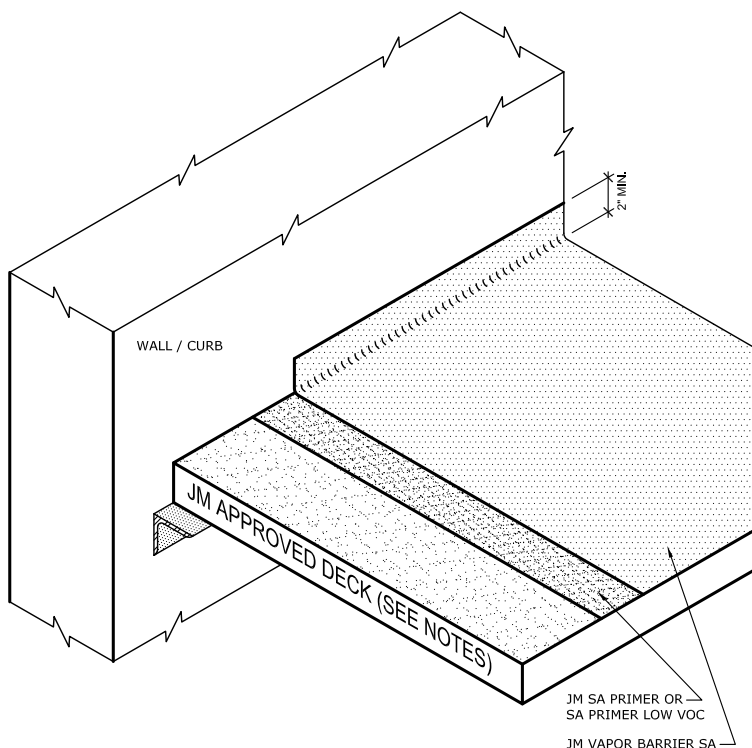

NOTES

1. USE DETAIL IN CONJUNCTION WITH THE STANDARD CURB DETAIL FOR APPROVED ROOF SYSTEM.
2. REFER TO JM VAPOR BARRIER AND PRIMER INSTALLATION INSTRUCTIONS FOR GENERAL GUIDELINES REGARDING THESE SYSTEMS.
3. FOR STEEL DECK SYSTEMS IT IS REQUIRED TO HAVE A MINIMUM OF 1/2" THERMAL BARRIER FASTENED TO STEEL DECK BEFORE JM VAPOR BARRIER IS ADHERED.

Johns Manville is a manufacturer of commercial roofing products and offers this general conceptual information to you as a courtesy. This complimentary assistance is not to be used or relied upon by anyone as a substitute for professional engineering design and documentation required by building code, contract, or applicable law. By accepting these comments you agree they do not constitute any representations, endorsements of, or an assumption by Johns Manville of any liability for either the adequacy of design of this building or any other material not supplied by Johns Manville.

Note: For the most current information on general guidelines, please refer to the System Considerations tab under Commercial Roofing Products on the JM Roofing Web site. For specifications, flashing details and general installation information please refer to the Application Tools tab.

Refer to the Safe Use Instructions and product label prior to using this product.



JM Vapor Barrier SA - Wall Base Detail - ALT

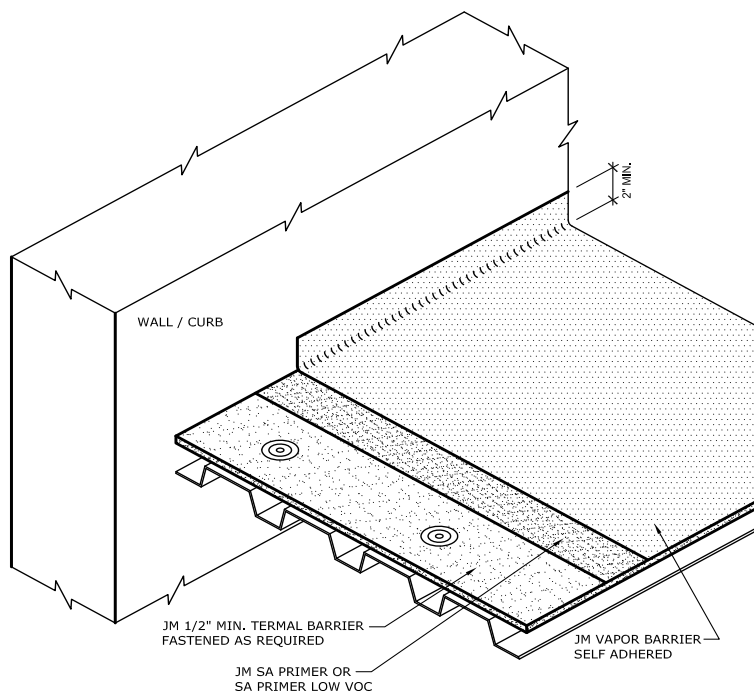

NOTES

1. USE DETAIL IN CONJUNCTION WITH THE STANDARD CURB DETAIL FOR APPROVED ROOF SYSTEM.
2. REFER TO JM VAPOR BARRIER AND PRIMER INSTALLATION INSTRUCTIONS FOR GENERAL GUIDELINES REGARDING THESE SYSTEMS.
3. FOR STEEL DECK SYSTEMS IT IS REQUIRED TO HAVE A MINIMUM OF 1/2" THERMAL BARRIER FASTENED TO STEEL DECK BEFORE JM VAPOR BARRIER IS ADHERED.

Johns Manville is a manufacturer of commercial roofing products and offers this general conceptual information to you as a courtesy. This complimentary assistance is not to be used or relied upon by anyone as a substitute for professional engineering design and documentation required by building code, contract, or applicable law. By accepting these comments you agree they do not constitute any representations, endorsements of, or an assumption by Johns Manville of any liability for either the adequacy of design of this building or any other material not supplied by Johns Manville.

Note: For the most current information on general guidelines, please refer to the System Considerations tab under Commercial Roofing Products on the JM Roofing Web site. For specifications, flashing details and general installation information please refer to the Application Tools tab.

Refer to the Safe Use Instructions and product label prior to using this product.



JM Vapor Barrier SA - Pipe Penetration Detail

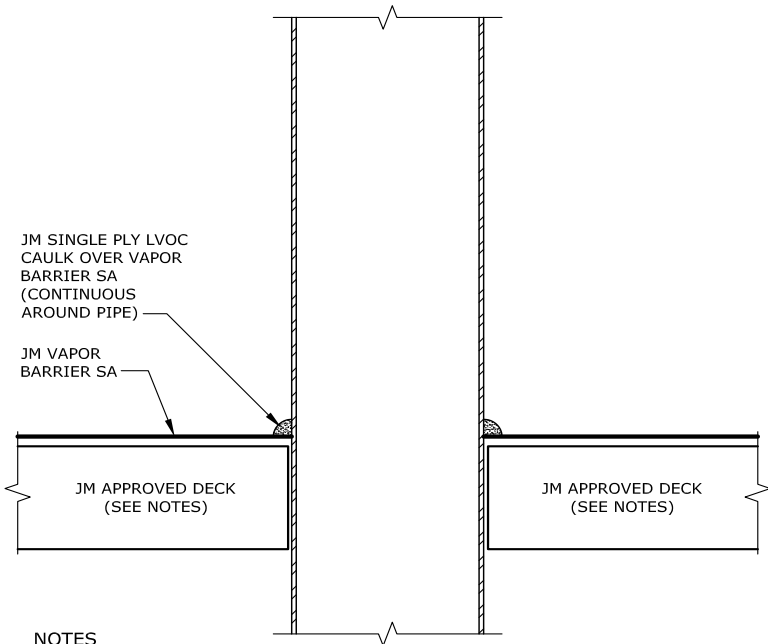

NOTES

1. USE DETAIL IN CONJUNCTION WITH THE STANDARD CURB DETAIL FOR APPROVED ROOF SYSTEM.
2. REFER TO JM VAPOR BARRIER AND PRIMER INSTALLATION INSTRUCTIONS FOR GENERAL GUIDELINES REGARDING THESE SYSTEMS.
3. FOR STEEL DECK SYSTEMS IT IS REQUIRED TO HAVE A MINIMUM OF 1/2" THERMAL BARRIER FASTENED TO STEEL DECK BEFORE JM VAPOR BARRIER IS ADHERED.

Johns Manville is a manufacturer of commercial roofing products and offers this general conceptual information to you as a courtesy. This complimentary assistance is not to be used or relied upon by anyone as a substitute for professional engineering design and documentation required by building code, contract, or applicable law. By accepting these comments you agree they do not constitute any representations, endorsements of, or an assumption by Johns Manville of any liability for either the adequacy of design of this building or any other material not supplied by Johns Manville.

Note: For the most current information on general guidelines, please refer to the System Considerations tab under Commercial Roofing Products on the JM Roofing Web site. For specifications, flashing details and general installation information please refer to the Application Tools tab.

Refer to the Safe Use Instructions and product label prior to using this product.



JM Vapor Barrier SA - Drain Detail

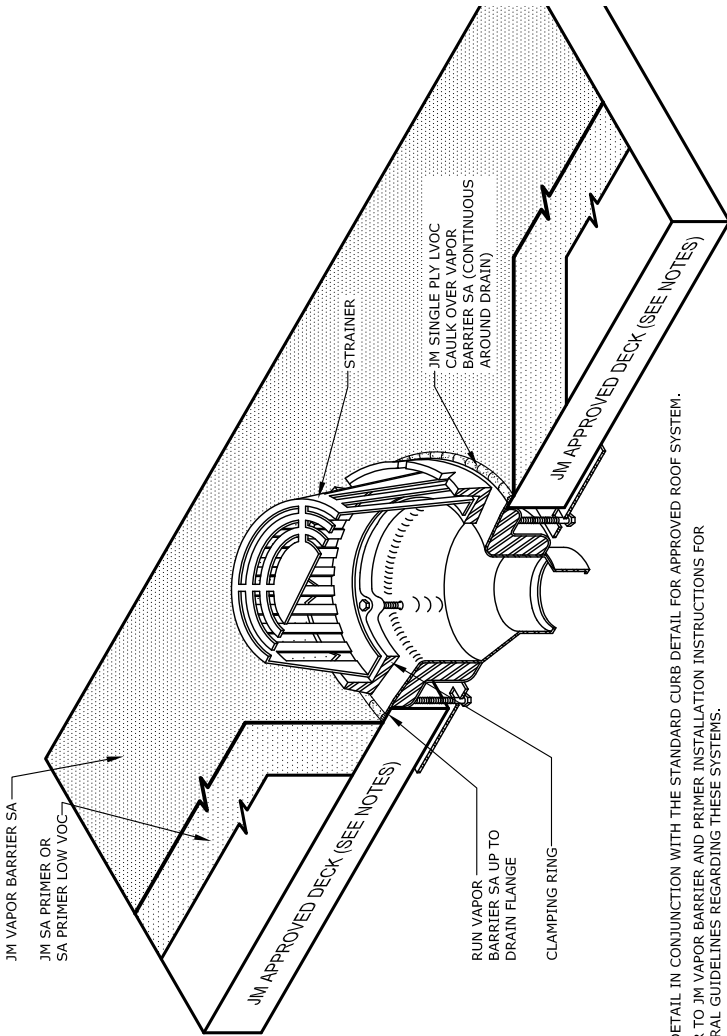

NOTES

1. USE DETAIL IN CONJUNCTION WITH THE STANDARD CURB DETAIL FOR APPROVED ROOF SYSTEM.
2. REFER TO JM VAPOR BARRIER AND PRIMER INSTALLATION INSTRUCTIONS FOR GENERAL GUIDELINES REGARDING THESE SYSTEMS.
3. FOR STEEL DECK SYSTEMS IT IS REQUIRED TO HAVE A MINIMUM OF 1/2" THERMAL BARRIER FASTENED TO STEEL DECK BEFORE JM VAPOR BARRIER IS ADHERED.

Johns Manville is a manufacturer of commercial roofing products and offers this general conceptual information to you as a courtesy. This complimentary assistance is not to be used or relied upon by anyone as a substitute for professional engineering design and documentation required by building code, contract, or applicable law. By accepting these comments you agree they do not constitute any representations, endorsements of, or an assumption by Johns Manville of any liability for either the adequacy of design of this building or any other material not supplied by Johns Manville.

Note: For the most current information on general guidelines, please refer to the System Considerations tab under Commercial Roofing Products on the JM Roofing Web site. For specifications, flashing details and general installation information please refer to the Application Tools tab.

Refer to the Safe Use Instructions and product label prior to using this product.



JM Vapor Barrier SA - Detail at Field Laps

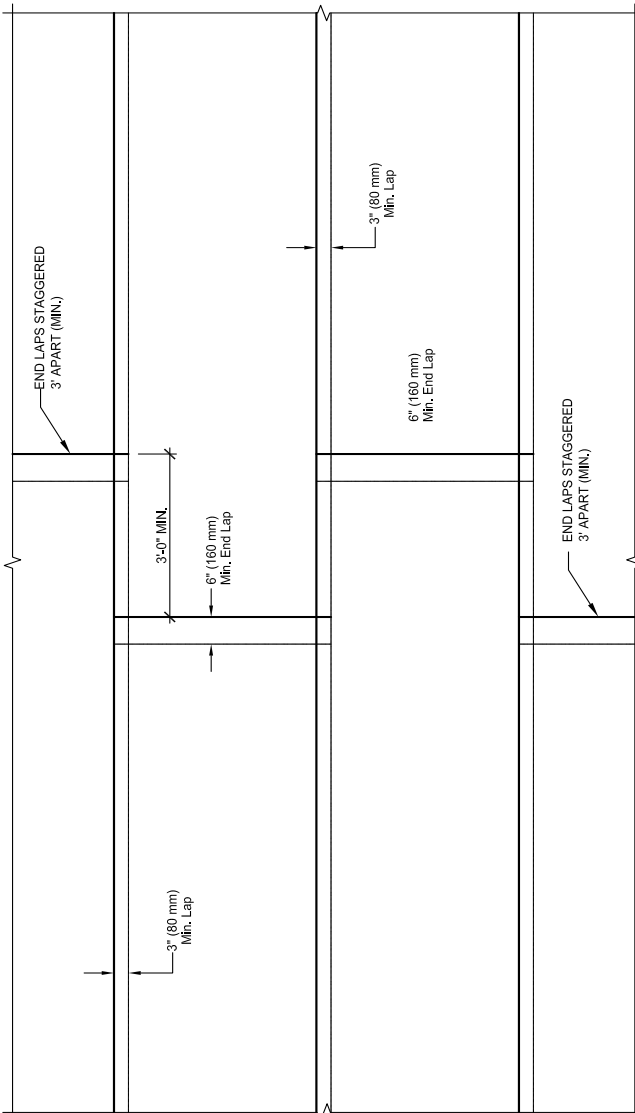

Johns Manville is a manufacturer of commercial roofing products and offers this general conceptual information to you as a courtesy. This complimentary assistance is not to be used or relied upon by anyone as a substitute for professional engineering design and documentation required by building code, contract, or applicable law. By accepting these comments you agree they do not constitute any representations, endorsements of, or an assumption by Johns Manville of any liability for either the adequacy of design of this building or any other material not supplied by Johns Manville.

Note: For the most current information on general guidelines, please refer to the System Considerations tab under Commercial Roofing Products on the JM Roofing Web site. For specifications, flashing details and general installation information please refer to the Application Tools tab.

Refer to the Safe Use Instructions and product label prior to using this product.



JM Vapor Barrier SA - Outside Curb Detail

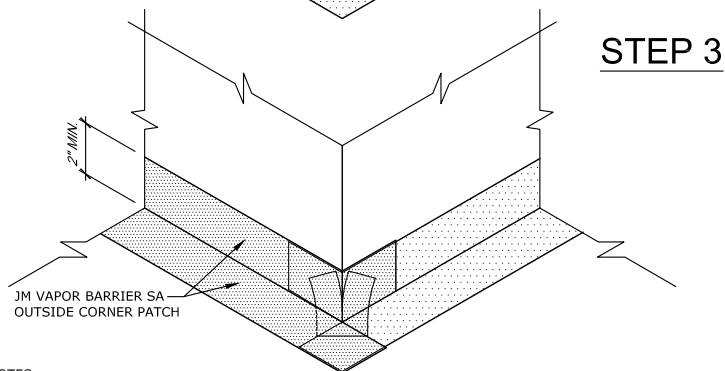
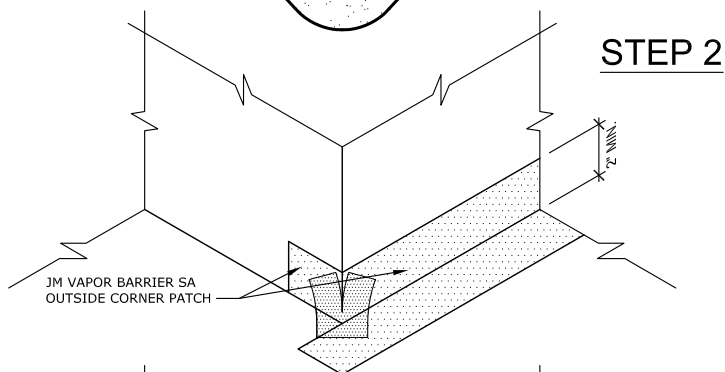
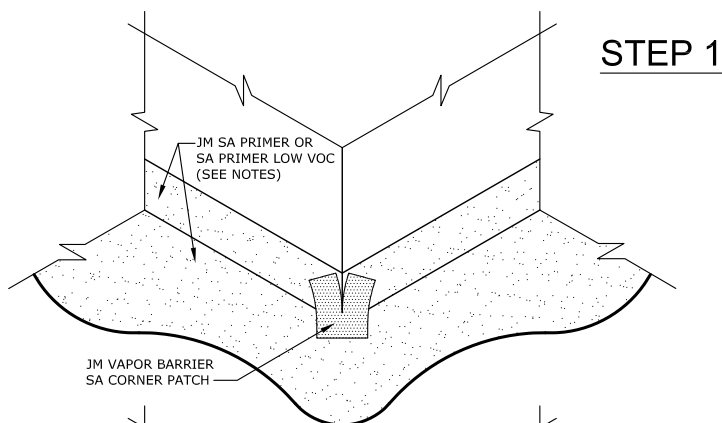

NOTES

1. USE DETAIL IN CONJUNCTION WITH THE STANDARD CURB DETAIL FOR APPROVED ROOF SYSTEM.
2. REFER TO JM VAPOR BARRIER AND PRIMER INSTALLATION INSTRUCTIONS FOR GENERAL GUIDELINES REGARDING THESE SYSTEMS.
3. FOR STEEL DECK SYSTEMS IT IS REQUIRED TO HAVE A MINIMUM OF 1/2" THERMAL BARRIER FASTENED TO STEEL DECK BEFORE JM VAPOR BARRIER IS ADHERED.

Johns Manville is a manufacturer of commercial roofing products and offers this general conceptual information to you as a courtesy. This complimentary assistance is not to be used or relied upon by anyone as a substitute for professional engineering design and documentation required by building code, contract, or applicable law. By accepting these comments you agree they do not constitute any representations, endorsements of, or an assumption by Johns Manville of any liability for either the adequacy of design of this building or any other material not supplied by Johns Manville.

Note: For the most current information on general guidelines, please refer to the System Considerations tab under Commercial Roofing Products on the JM Roofing Web site. For specifications, flashing details and general installation information please refer to the Application Tools tab.

Refer to the Safe Use Instructions and product label prior to using this product.



JM Vapor Barrier SA - Inside Curb Detail

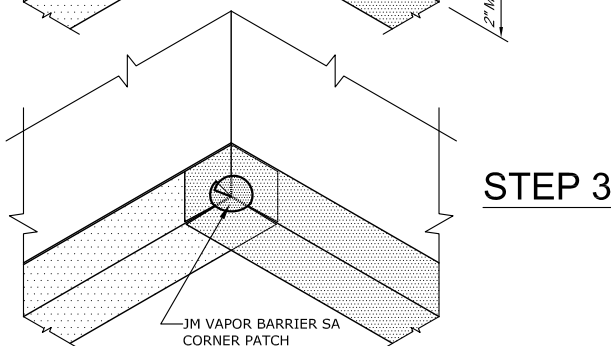
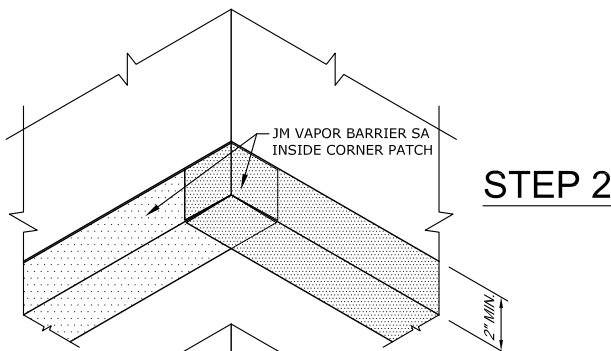
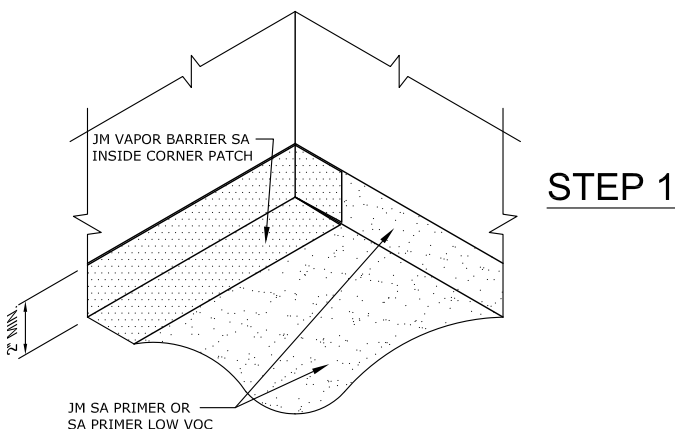

NOTES

1. USE DETAIL IN CONJUNCTION WITH THE STANDARD CURB DETAIL FOR APPROVED ROOF SYSTEM.
2. REFER TO JM VAPOR BARRIER AND PRIMER INSTALLATION INSTRUCTIONS FOR GENERAL GUIDELINES REGARDING THESE SYSTEMS.
3. FOR STEEL DECK SYSTEMS IT IS REQUIRED TO HAVE A MINIMUM OF 1/2" THERMAL BARRIER FASTENED TO STEEL DECK BEFORE JM VAPOR BARRIER IS ADHERED.

Johns Manville is a manufacturer of commercial roofing products and offers this general conceptual information to you as a courtesy. This complimentary assistance is not to be used or relied upon by anyone as a substitute for professional engineering design and documentation required by building code, contract, or applicable law. By accepting these comments you agree they do not constitute any representations, endorsements of, or an assumption by Johns Manville of any liability for either the adequacy of design of this building or any other material not supplied by Johns Manville.

Note: For the most current information on general guidelines, please refer to the System Considerations tab under Commercial Roofing Products on the JM Roofing Web site. For specifications, flashing details and general installation information please refer to the Application Tools tab.

Refer to the Safe Use Instructions and product label prior to using this product.

Single Ply Roofing Systems Details Specification

Isometric (Only Isometric Views of 2D Details End With "I")

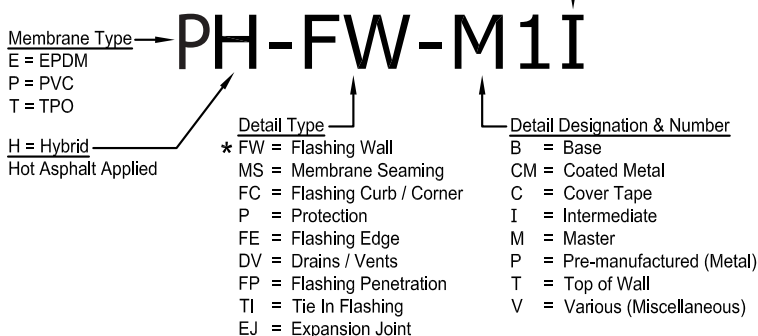

* Flashing Wall (FW) Details have Master Details (M) in both 2D and Isometric that coordinate all the other Flashing Wall (FW) details.

PVC Hybrid

New Detail Number	Old Detail Number	Detail Description	Attachment Method FA	Page No.
Drain & Vents Details				
PH-DV-01	New	Field Fabricated Vent Pipe	X	4-119
PH-DV-02	New	Drain Detail	X	4-120
PH-DV-03	New	Vent Pipe	X	4-121
Flashing Edge Details				
<u>PVC-Coated Metal Details</u>				
PH-FE-CM1	New	Drip Edge - PVC-Coated Metal	X	4-122
PH-FE-CM2	New	Gravel Stop - PVC-Coated Metal	X	4-123
PH-FE-CM3	New	Gutter & PVC-Coated Metal Edge	X	4-124
<u>Pre-Manufactured (Metal) Details</u>				
PH-FE-P1	New	JM Presto-Lock Fascia System	X	4-125
PH-FE-P2	New	JM Presto-Tite Fascia System	X	4-126
Flashing Wall Details				
<u>Base Tie-In Details</u>				
PH-FW-B1	New	Membrane Flashing Base Tie-In - High Internal Pressure	X	4-127
PH-FW-B2	New	Base Tie-In Fastener & Plate - on Wall	X	4-128
PH-FW-B3	New	Base Tie-In Fastener & Plate - with Cant	X	4-129
PH-FW-B4	New	Base Tie-In with Termination Bar	X	4-130
<u>Master Details</u>				
PH-FW-M1	New	PVC Hybrid Base & Wall Flashing with Coping Master	X	4-131
PH-FW-M1I	New	PVC Hybrid Base & Wall Flashing with Coping Isometric View	X	4-132
PH-FW-M2I	New	Highwall Flashing with Metal Backing Strip Isometric View	X	4-133
Flashing Curb & Corner Details				
PH-FC-01	New	Prefabricated Metal Curb Base Flashing with Curb	X	4-134
PH-FC-02	New	Prefabricated Metal Base Flashing	X	4-135
Flashing Penetration Details				
PH-FP-01	New	Pipe Boot	X	4-136
PH-MS-01	New	PVC Fleece Backed Membrane Butted End Lap	X	4-137



Field Fabricated Vent Pipe

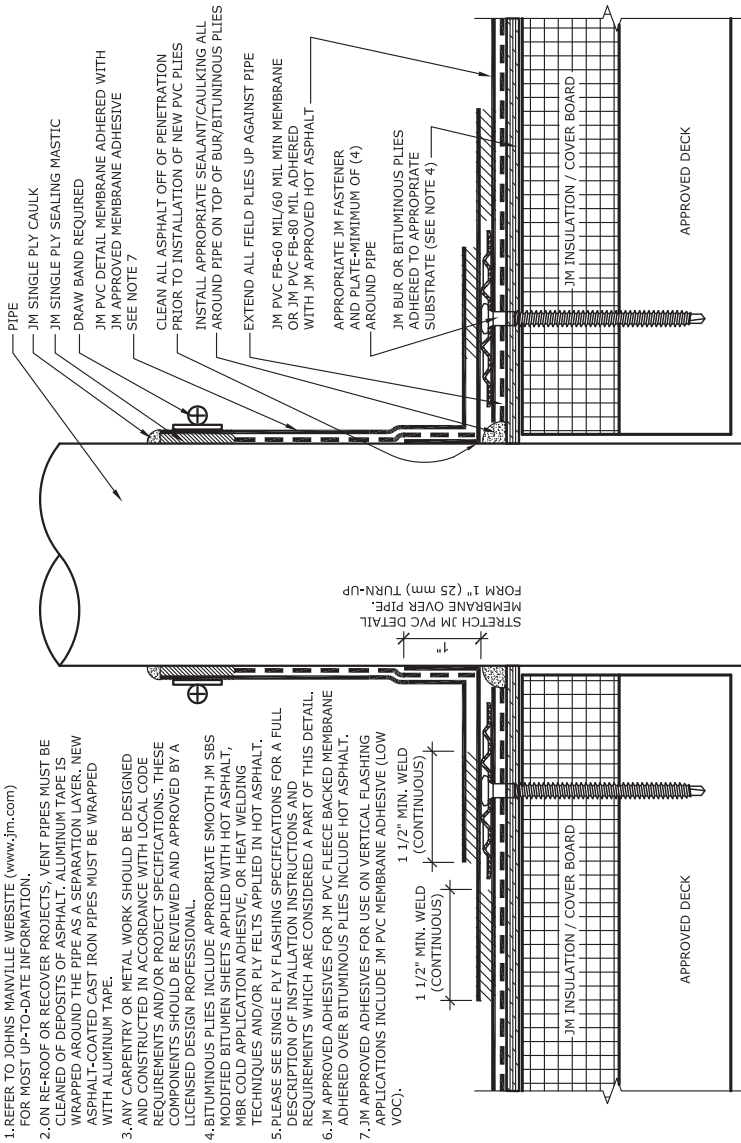

Maximum Guarantee Term: 20 Year

Johns Manville is a manufacturer of commercial roofing products and offers this general conceptual information to you as a courtesy. This complimentary assistance is not to be used or relied upon by anyone as a substitute for professional engineering design and documentation required by building code, contract, or applicable law. By accepting these comments you agree they do not constitute any representations, endorsements of, or an assumption by Johns Manville of any liability for either the adequacy of design of this building or any other material not supplied by Johns Manville.

Note: For the most current information on general guidelines, please refer to the System Considerations tab under Commercial Roofing Products on the JM Roofing Web site. For specifications, flashing details and general installation information please refer to the Application Tools tab.

Refer to the Safe Use Instructions and product label prior to using this product.



Drain Detail

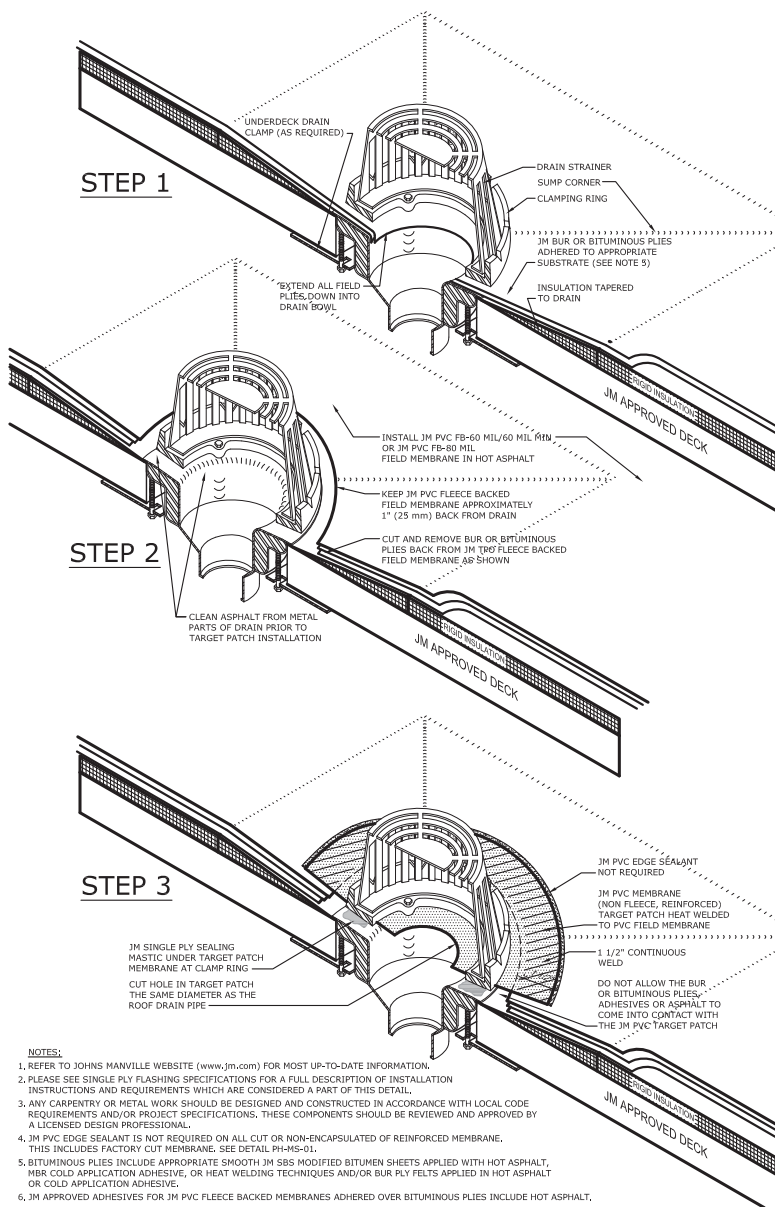

NOTES:

1. REFER TO JOHNS MANVILLE WEBSITE (www.jm.com) FOR MOST UP-TO-DATE INFORMATION.
2. PLEASE SEE SINGLE PLY FLASHING SPECIFICATIONS FOR A FULL DESCRIPTION OF INSTALLATION INSTRUCTIONS AND REQUIREMENTS WHICH ARE CONSIDERED A PART OF THIS DETAIL.
3. ANY CARPENTRY OR METAL WORK SHOULD BE DESIGNED AND CONSTRUCTED IN ACCORDANCE WITH LOCAL CODE REQUIREMENTS AND/OR PROJECT SPECIFICATIONS. THESE COMPONENTS SHOULD BE REVIEWED AND APPROVED BY A LICENSED DESIGN PROFESSIONAL.
4. JM PVC EDGE SEALANT IS NOT REQUIRED ON ALL CUT OR NON-ENCAPSULATED OF REINFORCED MEMBRANE. THIS INCLUDES FACTORY CUT MEMBRANE. SEE DETAIL PH-MS-01.
5. BITUMINOUS PILES INCLUDE APPROPRIATE SMOOTH JM SBS MODIFIED BITUMEN SHEETS APPLIED WITH HOT ASPHALT, MBR COLD APPLICATION ADHESIVE, OR HEAT WELDING TECHNIQUES AND/OR BUR PLY FELTS APPLIED IN HOT ASPHALT OR COLD APPLICATION ADHESIVE.
6. JM APPROVED ADHESIVES FOR JM PVC FLEECE BACKED MEMBRANES ADHERED OVER BITUMINOUS PILES INCLUDE HOT ASPHALT.

Johns Manville is a manufacturer of commercial roofing products and offers this general conceptual information to you as a courtesy. This complimentary assistance is not to be used or relied upon by anyone as a substitute for professional engineering design and documentation required by building code, contract, or applicable law. By accepting these comments you agree they do not constitute any representations, endorsements of, or an assumption by Johns Manville of any liability for either the adequacy of design of this building or any other material not supplied by Johns Manville.

Note: For the most current information on general guidelines, please refer to the System Considerations tab under Commercial Roofing Products on the JM Roofing Web site. For specifications, flashing details and general installation information please refer to the Application Tools tab.

Refer to the Safe Use Instructions and product label prior to using this product.



Drip Edge - PVC Coated Metal

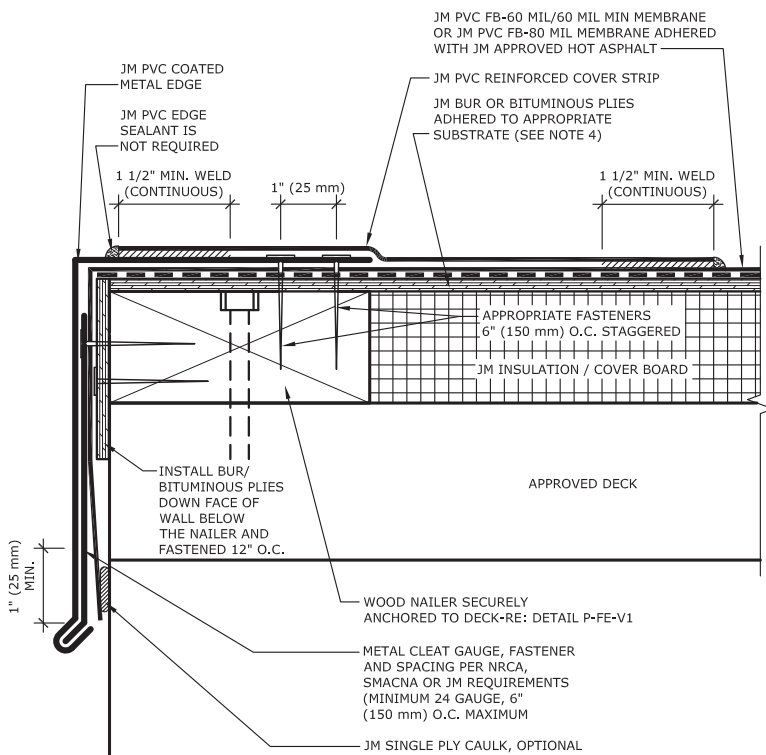

NOTES:

1. REFER TO JOHNS MANVILLE WEBSITE (www.jm.com) FOR MOST UP-TO-DATE INFORMATION.
2. PLEASE SEE SINGLE PLY FLASHING SPECIFICATIONS FOR A FULL DESCRIPTION OF INSTALLATION INSTRUCTIONS AND REQUIREMENTS WHICH ARE CONSIDERED A PART OF THIS DETAIL.
3. ANY CARPENTRY OR METAL WORK SHOULD BE DESIGNED AND CONSTRUCTED IN ACCORDANCE WITH LOCAL CODE REQUIREMENTS AND/OR PROJECT SPECIFICATIONS. THESE COMPONENTS SHOULD BE REVIEWED AND APPROVED BY A LICENSED DESIGN PROFESSIONAL.
4. BITUMINOUS PLIES INCLUDE APPROPRIATE SMOOTH JM SBS MODIFIED BITUMEN SHEETS APPLIED WITH HOT ASPHALT, MBR COLD APPLICATION ADHESIVE, OR HEAT WELDING TECHNIQUES AND/OR PLY FELTS APPLIED IN HOT ASPHALT.
5. JM PVC EDGE SEALANT IS NOT REQUIRED ON ALL CUT OR NON-ENCAPSULATED EDGES OF REINFORCED MEMBRANE. THIS INCLUDES FACTORY CUT MEMBRANE. SEE DETAIL P-MS-01.
6. JM APPROVED ADHESIVES FOR JM PVC FLEECE BACKED MEMBRANE ADHERED OVER BITUMINOUS PLIES INCLUDE HOT ASPHALT.

Maximum Guarantee Term: 20 Year

Johns Manville is a manufacturer of commercial roofing products and offers this general conceptual information to you as a courtesy. This complimentary assistance is not to be used or relied upon by anyone as a substitute for professional engineering design and documentation required by building code, contract, or applicable law. By accepting these comments you agree they do not constitute any representations, endorsements of, or an assumption by Johns Manville of any liability for either the adequacy of design of this building or any other material not supplied by Johns Manville.

Note: For the most current information on general guidelines, please refer to the System Considerations tab under Commercial Roofing Products on the JM Roofing Web site. For specifications, flashing details and general installation information please refer to the Application Tools tab.

Refer to the Safe Use Instructions and product label prior to using this product.



Gravel Stop - PVC Coated Metal

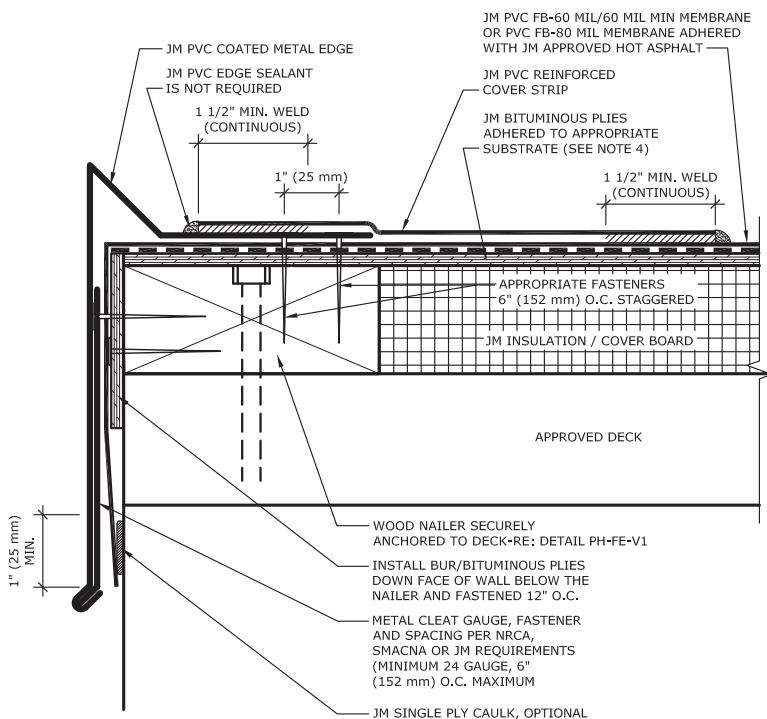

NOTES:

1. REFER TO JOHNS MANVILLE WEBSITE (www.jm.com) FOR MOST UP-TO-DATE INFORMATION.
2. PLEASE SEE SINGLE PLY FLASHING SPECIFICATIONS FOR A FULL DESCRIPTION OF INSTALLATION INSTRUCTIONS AND REQUIREMENTS WHICH ARE CONSIDERED A PART OF THIS DETAIL.
3. ANY CARPENTRY OR METAL WORK SHOULD BE DESIGNED AND CONSTRUCTED IN ACCORDANCE WITH LOCAL CODE REQUIREMENTS AND/OR PROJECT SPECIFICATIONS. THESE COMPONENTS SHOULD BE REVIEWED AND APPROVED BY A LICENSED DESIGN PROFESSIONAL.
4. BITUMINOUS PLIES INCLUDE APPROPRIATE SMOOTH JM SBS MODIFIED BITUMEN SHEETS APPLIED WITH HOT ASPHALT, MBR COLD APPLICATION ADHESIVE, OR HEAT WELDING TECHNIQUES AND/OR PLY FELTS APPLIED IN HOT ASPHALT.
5. JM PVC EDGE SEALANT IS NOT REQUIRED ON ALL CUT OR NON-ENCAPSULATED EDGES OF REINFORCED MEMBRANE. THIS INCLUDES FACTORY CUT MEMBRANE. SEE DETAIL PH-MS-01.
6. JM APPROVED ADHESIVES FOR JM PVC FLEECE BACKED MEMBRANE ADHERED OVER BITUMINOUS PLIES INCLUDE HOT ASPHALT.

Maximum Guarantee Term: 20 Year

Johns Manville is a manufacturer of commercial roofing products and offers this general conceptual information to you as a courtesy. This complimentary assistance is not to be used or relied upon by anyone as a substitute for professional engineering design and documentation required by building code, contract, or applicable law. By accepting these comments you agree they do not constitute any representations, endorsements of, or an assumption by Johns Manville of any liability for either the adequacy of design of this building or any other material not supplied by Johns Manville.

Note: For the most current information on general guidelines, please refer to the System Considerations tab under Commercial Roofing Products on the JM Roofing Web site. For specifications, flashing details and general installation information please refer to the Application Tools tab.

Refer to the Safe Use Instructions and product label prior to using this product.



Gutter & PVC Coated Metal Edge

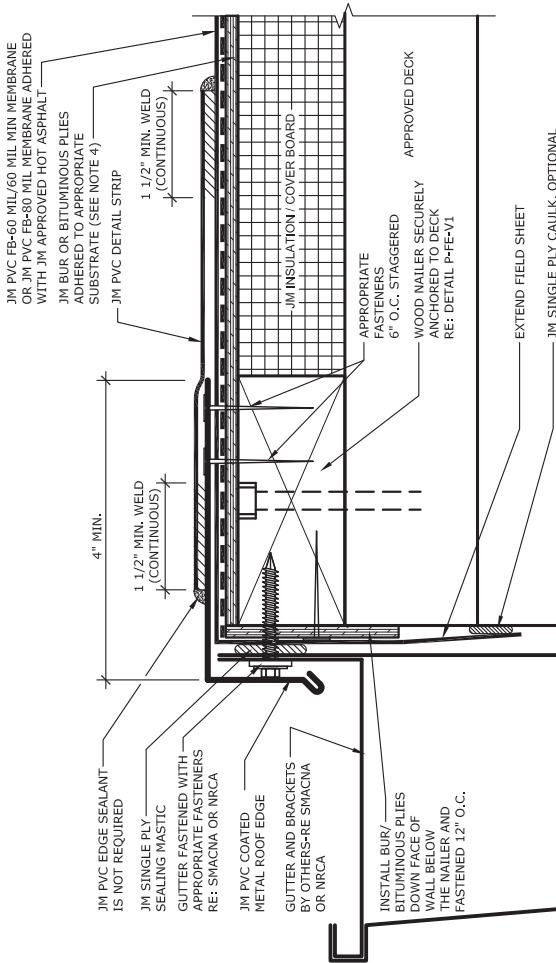

NOTES:

1. REFER TO JOHNS MANVILLE WEBSITE (www.jm.com) FOR MOST UP-TO-DATE INFORMATION.
2. PLEASE SEE SINGLE PLY FLASHING SPECIFICATIONS FOR A FULL DESCRIPTION OF INSTALLATION INSTRUCTIONS AND REQUIREMENTS WHICH ARE CONSIDERED A PART OF THIS DETAIL.
3. ANY CARPENTRY OR METAL WORK SHOULD BE DESIGNED AND CONSTRUCTED IN ACCORDANCE WITH LOCAL CODE REQUIREMENTS AND/OR PROJECT SPECIFICATIONS. THESE COMPONENTS SHOULD BE REVIEWED AND APPROVED BY A LICENSED DESIGN PROFESSIONAL.
4. BITUMINOUS PLYS INCLUDE APPROPRIATE SMOOTH JM SBS MODIFIED BITUMEN SHEETS APPLIED WITH HOT ASPHALT, MBR COLD APPLICATION ADHESIVE, OR HEAT WELDING TECHNIQUES AND/OR PLY FELTS APPLIED IN HOT ASPHALT.
5. JM PVC EDGE SEALANT IS NOT REQUIRED ON ALL CUT OR NON-ENCAPSULATED EDGES OF REINFORCED MEMBRANE. THIS INCLUDES FACTORY CUT MEMBRANE. SEE DETAIL PH-MS-01.
6. JM APPROVED ADHESIVES FOR JM PVC FLEECE BACKED MEMBRANE ADHERED OVER BITUMINOUS PLYS INCLUDE HOT ASPHALT.

Maximum Guarantee Term: 20 Year

Johns Manville is a manufacturer of commercial roofing products and offers this general conceptual information to you as a courtesy. This complimentary assistance is not to be used or relied upon by anyone as a substitute for professional engineering design and documentation required by building code, contract, or applicable law. By accepting these comments you agree they do not constitute any representations, endorsements, or an assumption by Johns Manville of any liability for either the adequacy of design of this building or any other material not supplied by Johns Manville.

Note: For the most current information on general guidelines, please refer to the System Considerations tab under Commercial Roofing Products on the JM Roofing Web site. For specifications, flashing details and general installation information please refer to the Application Tools tab.

Refer to the Safe Use Instructions and product label prior to using this product.



JM Presto Lock Fascia System

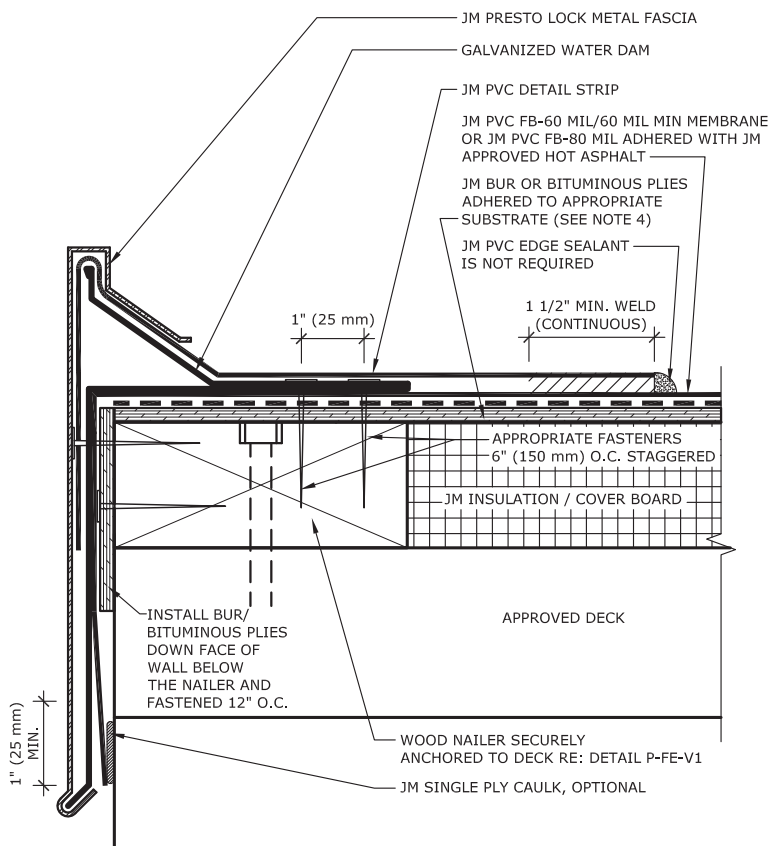

NOTES:

1. REFER TO JOHNS MANVILLE WEBSITE (www.jm.com) FOR MOST UP-TO-DATE INFORMATION.
2. PLEASE SEE SINGLE PLY FLASHING SPECIFICATIONS FOR A FULL DESCRIPTION OF INSTALLATION INSTRUCTIONS AND REQUIREMENTS WHICH ARE CONSIDERED A PART OF THIS DETAIL.
3. ANY CARPENTRY OR METAL WORK SHOULD BE DESIGNED AND CONSTRUCTED IN ACCORDANCE WITH LOCAL CODE REQUIREMENTS AND/OR PROJECT SPECIFICATIONS. THESE COMPONENTS SHOULD BE REVIEWED AND APPROVED BY A LICENSED DESIGN PROFESSIONAL.
4. BITUMINOUS PLIES INCLUDE APPROPRIATE SMOOTH JM SBS MODIFIED BITUMEN SHEETS APPLIED WITH HOT ASPHALT, MBR COLD APPLICATION ADHESIVE, OR HEAT WELDING TECHNIQUES AND/OR PLY FELTS APPLIED IN HOT ASPHALT.
5. JM PVC EDGE SEALANT IS NOT REQUIRED ON ALL CUT OR NON-ENCAPSULATED EDGES OF REINFORCED MEMBRANE. THIS INCLUDES FACTORY CUT MEMBRANE. SEE DETAIL PH-MS-01.
6. JM APPROVED ADHESIVES FOR JM PVC FLEECE BACKED MEMBRANE ADHERED OVER BITUMINOUS PLIES INCLUDE HOT ASPHALT.

Maximum Guarantee Term: 20 Year

Johns Manville is a manufacturer of commercial roofing products and offers this general conceptual information to you as a courtesy. This complimentary assistance is not to be used or relied upon by anyone as a substitute for professional engineering design and documentation required by building code, contract, or applicable law. By accepting these comments you agree they do not constitute any representations, endorsements of, or an assumption by Johns Manville of any liability for either the adequacy of design of this building or any other material not supplied by Johns Manville.

Note: For the most current information on general guidelines, please refer to the System Considerations tab under Commercial Roofing Products on the JM Roofing Web site. For specifications, flashing details and general installation information please refer to the Application Tools tab.

Refer to the Safe Use Instructions and product label prior to using this product.



Presto-Tite Fascia System

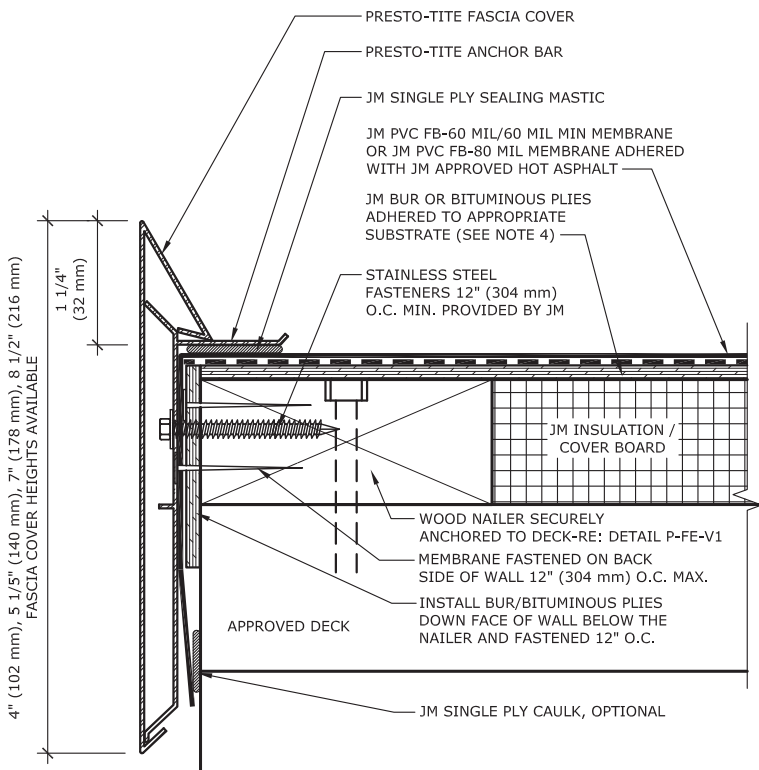

NOTES:

1. REFER TO JOHNS MANVILLE WEBSITE (www.jm.com) FOR MOST UP-TO-DATE INFORMATION.
2. PLEASE SEE SINGLE PLY FLASHING SPECIFICATIONS FOR A FULL DESCRIPTION OF INSTALLATION INSTRUCTIONS AND REQUIREMENTS WHICH ARE CONSIDERED A PART OF THIS DETAIL.
3. ANY CARPENTRY OR METAL WORK SHOULD BE DESIGNED AND CONSTRUCTED IN ACCORDANCE WITH LOCAL CODE REQUIREMENTS AND/OR PROJECT SPECIFICATIONS. THESE COMPONENTS SHOULD BE REVIEWED AND APPROVED BY A LICENSED DESIGN PROFESSIONAL.
4. BITUMINOUS PLYS INCLUDE APPROPRIATE SMOOTH JM SBS MODIFIED BITUMEN SHEETS APPLIED WITH HOT ASPHALT, MBR COLD APPLICATION ADHESIVE, OR HEAT WELDING TECHNIQUES AND/OR PLY FELTS APPLIED IN HOT ASPHALT.
5. JM PVC EDGE SEALANT IS NOT REQUIRED ON ALL CUT OR NON-ENCAPSULATED EDGES OF REINFORCED MEMBRANE. THIS INCLUDES FACTORY CUT MEMBRANE. SEE DETAIL PH-MS-01.
6. JM APPROVED ADHESIVES FOR JM PVC FLEECE BACKED MEMBRANE ADHERED OVER BITUMINOUS PLYS INCLUDE HOT ASPHALT.

Maximum Guarantee Term: 20 Year

Johns Manville is a manufacturer of commercial roofing products and offers this general conceptual information to you as a courtesy. This complimentary assistance is not to be used or relied upon by anyone as a substitute for professional engineering design and documentation required by building code, contract, or applicable law. By accepting these comments you agree they do not constitute any representations, endorsements of, or an assumption by Johns Manville of any liability for either the adequacy of design of this building or any other material not supplied by Johns Manville.

Note: For the most current information on general guidelines, please refer to the System Considerations tab under Commercial Roofing Products on the JM Roofing Web site. For specifications, flashing details and general installation information please refer to the Application Tools tab.

Refer to the Safe Use Instructions and product label prior to using this product.



Membrane Flashing Base Tie-In - High Internal Pressure

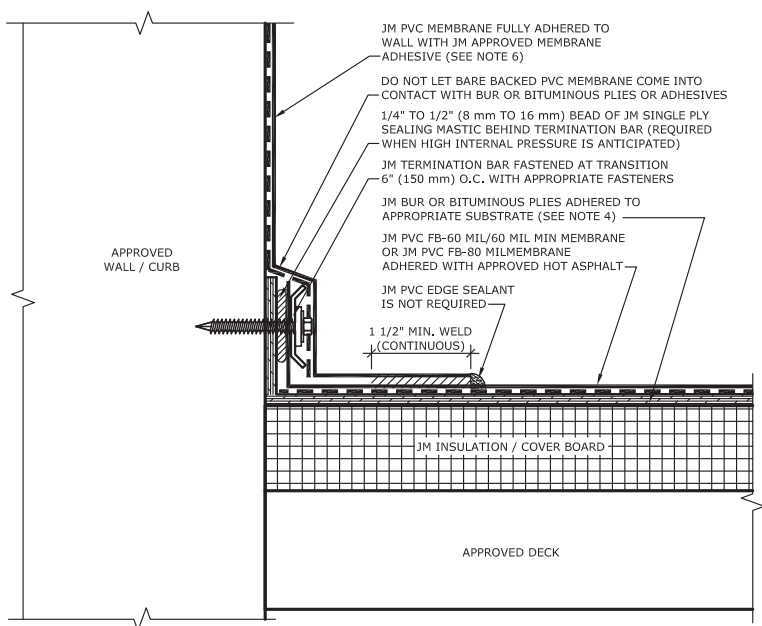

NOTES:

1. REFER TO JOHNS MANVILLE WEBSITE (www.jm.com) FOR MOST UP-TO-DATE INFORMATION.
2. PLEASE SEE SINGLE PLY FLASHING SPECIFICATIONS FOR A FULL DESCRIPTION OF INSTALLATION INSTRUCTIONS AND REQUIREMENTS WHICH ARE CONSIDERED A PART OF THIS DETAIL.
3. ANY CARPENTRY OR METAL WORK SHOULD BE DESIGNED AND CONSTRUCTED IN ACCORDANCE WITH LOCAL CODE REQUIREMENTS AND/OR PROJECT SPECIFICATIONS. THESE COMPONENTS SHOULD BE REVIEWED AND APPROVED BY A LICENSED DESIGN PROFESSIONAL.
4. BITUMINOUS PLYS INCLUDE APPROPRIATE SMOOTH JM SBS MODIFIED BITUMEN SHEETS APPLIED WITH HOT ASPHALT, MBR COLD APPLICATION ADHESIVE, OR HEAT WELDING TECHNIQUES AND/OR PLY FELTS APPLIED IN HOT ASPHALT.
5. JM PVC EDGE SEALANT IS NOT REQUIRED ON ALL CUT OR NON-ENCAPSULATED EDGES OF REINFORCED MEMBRANE. THIS INCLUDES FACTORY CUT MEMBRANE. SEE DETAIL P-MS-01.
6. JM APPROVED ADHESIVES FOR USE ON VERTICAL FLASHING APPLICATIONS INCLUDES JM PVC MEMBRANE ADHESIVE (LOW VOC)
7. JM APPROVED ADHESIVES FOR JM PVC FLEECE BACKED MEMBRANE ADHERED OVER BITUMINOUS PLYS INCLUDE HOT ASPHALT.

Maximum Guarantee Term: 20 Year

Johns Manville is a manufacturer of commercial roofing products and offers this general conceptual information to you as a courtesy. This complimentary assistance is not to be used or relied upon by anyone as a substitute for professional engineering design and documentation required by building code, contract, or applicable law. By accepting these comments you agree they do not constitute any representations, endorsements of, or an assumption by Johns Manville of any liability for either the adequacy of design of this building or any other material not supplied by Johns Manville.

Note: For the most current information on general guidelines, please refer to the System Considerations tab under Commercial Roofing Products on the JM Roofing Web site. For specifications, flashing details and general installation information please refer to the Application Tools tab.

Refer to the Safe Use Instructions and product label prior to using this product.



Base Tie-In - Fastener & Plate

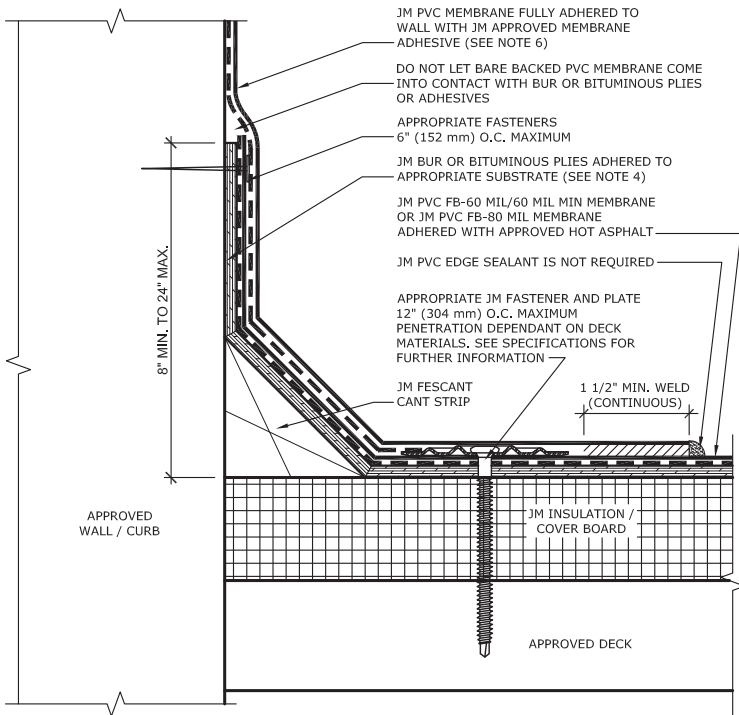

NOTES:

1. REFER TO JOHNS MANVILLE WEBSITE (www.jm.com) FOR MOST UP-TO-DATE INFORMATION.
2. PLEASE SEE SINGLE PLY FLASHING SPECIFICATIONS FOR A FULL DESCRIPTION OF INSTALLATION INSTRUCTIONS AND REQUIREMENTS WHICH ARE CONSIDERED A PART OF THIS DETAIL.
3. ANY CARPENTRY OR METAL WORK SHOULD BE DESIGNED AND CONSTRUCTED IN ACCORDANCE WITH LOCAL CODE REQUIREMENTS AND/OR PROJECT SPECIFICATIONS. THESE COMPONENTS SHOULD BE REVIEWED AND APPROVED BY A LICENSED DESIGN PROFESSIONAL.
4. BITUMINOUS PLIES INCLUDE APPROPRIATE SMOOTH JM SBS MODIFIED BITUMEN SHEETS APPLIED WITH HOT ASPHALT, MBR COLD APPLICATION ADHESIVE, OR HEAT WELDING TECHNIQUES AND/OR PLY FELTS APPLIED IN HOT ASPHALT.
5. JM PVC EDGE SEALANT IS NOT REQUIRED ON ALL CUT OR NON-ENCAPSULATED EDGES OF REINFORCED MEMBRANE. THIS INCLUDES FACTORY CUT MEMBRANE. SEE DETAIL PH-MS-01.
6. JM APPROVED ADHESIVES FOR USE ON VERTICAL FLASHING APPLICATIONS INCLUDES JM PVC MEMBRANE ADHESIVE (LOW VOC).
7. JM APPROVED ADHESIVES FOR JM PVC FLEECE BACKED MEMBRANE ADHERED OVER BITUMINOUS PLIES INCLUDE HOT ASPHALT.

Maximum Guarantee Term: 20 Year

Johns Manville is a manufacturer of commercial roofing products and offers this general conceptual information to you as a courtesy. This complimentary assistance is not to be used or relied upon by anyone as a substitute for professional engineering design and documentation required by building code, contract, or applicable law. By accepting these comments you agree they do not constitute any representations, endorsements of, or an assumption by Johns Manville of any liability for either the adequacy of design of this building or any other material not supplied by Johns Manville.

Note: For the most current information on general guidelines, please refer to the System Considerations tab under Commercial Roofing Products on the JM Roofing Web site. For specifications, flashing details and general installation information please refer to the Application Tools tab.

Refer to the Safe Use Instructions and product label prior to using this product.



Base Tie-In - Fastener & Plate - On Wall

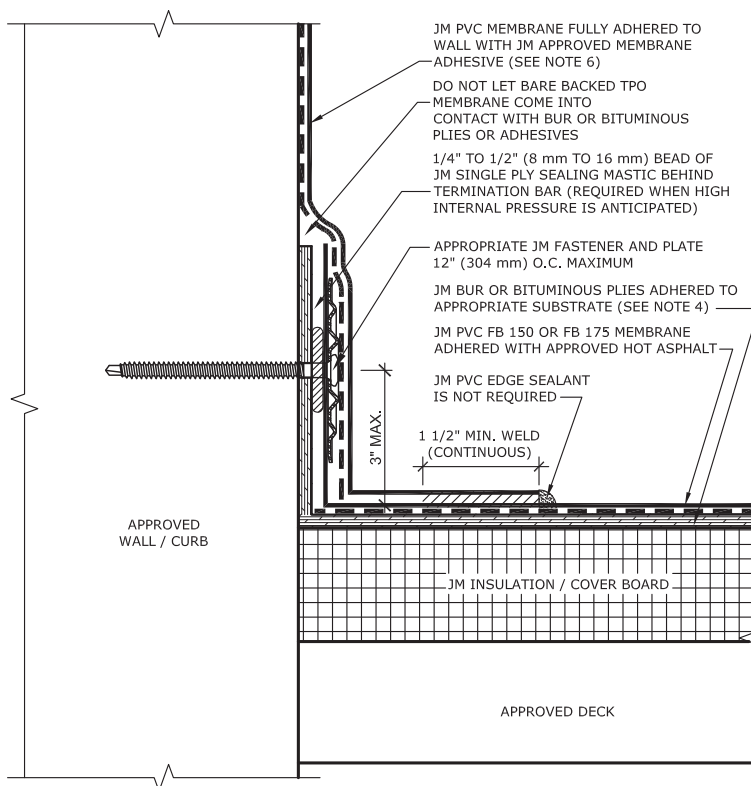

NOTES:

- REFER TO JOHNS MANVILLE WEBSITE (www.jm.com) FOR MOST UP-TO-DATE INFORMATION.
- PLEASE SEE SINGLE PLY FLASHING SPECIFICATIONS FOR A FULL DESCRIPTION OF INSTALLATION INSTRUCTIONS AND REQUIREMENTS WHICH ARE CONSIDERED A PART OF THIS DETAIL.
- ANY CARPENTRY OR METAL WORK SHOULD BE DESIGNED AND CONSTRUCTED IN ACCORDANCE WITH LOCAL CODE REQUIREMENTS AND/OR PROJECT SPECIFICATIONS. THESE COMPONENTS SHOULD BE REVIEWED AND APPROVED BY A LICENSED DESIGN PROFESSIONAL.
- BITUMINOUS PLIES INCLUDE APPROPRIATE SMOOTH JM SBS MODIFIED BITUMEN SHEETS APPLIED WITH HO ASPHALT, MBR COLD APPLICATION ADHESIVE, OR HEAT WELDING TECHNIQUES AND/OR PLY FELTS APPLIED IN HOT ASPHALT.
- JM PVC EDGE SEALANT IS NOT REQUIRED ON ALL CUT OR NON-ENCAPSULATED EDGES OF REINFORCED MEMBRANE. THIS INCLUDES FACTORY CUT MEMBRANE. SEE DETAIL P-MS-01.
- JM APPROVED ADHESIVES FOR USE ON VERTICAL FLASHING APPLICATIONS INCLUDES JM PVC MEMBRANE ADHESIVE (LOW VOC).
- JM APPROVED ADHESIVES FOR JM PVC FLEECE BACKED MEMBRANE ADHERED OVER BITUMINOUS PLIES INCLUDE HOT ASPHALT.

Maximum Guarantee Term: 20 Year

Johns Manville is a manufacturer of commercial roofing products and offers this general conceptual information to you as a courtesy. This complimentary assistance is not to be used or relied upon by anyone as a substitute for professional engineering design and documentation required by building code, contract, or applicable law. By accepting these comments you agree they do not constitute any representations, endorsements of, or an assumption by Johns Manville of any liability for either the adequacy of design of this building or any other material not supplied by Johns Manville.

Note: For the most current information on general guidelines, please refer to the System Considerations tab under Commercial Roofing Products on the JM Roofing Web site. For specifications, flashing details and general installation information please refer to the Application Tools tab.

Refer to the Safe Use Instructions and product label prior to using this product.



Base Tie-In With Termination Bar

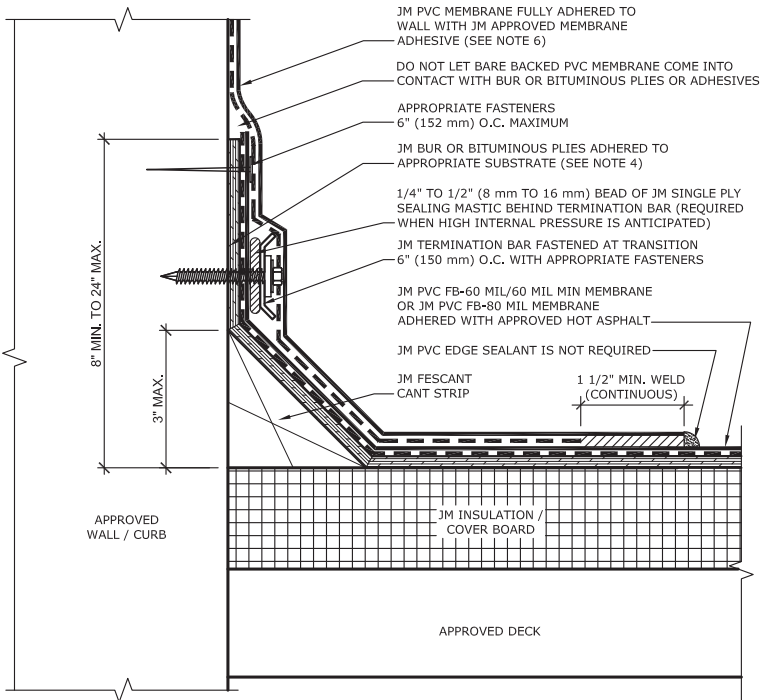

NOTES:

1. REFER TO JOHNS MANVILLE WEBSITE (www.jm.com) FOR MOST UP-TO-DATE INFORMATION.
2. PLEASE SEE SINGLE PLY FLASHING SPECIFICATIONS FOR A FULL DESCRIPTION OF INSTALLATION INSTRUCTIONS AND REQUIREMENTS WHICH ARE CONSIDERED A PART OF THIS DETAIL.
3. ANY CARPENTRY OR METAL WORK SHOULD BE DESIGNED AND CONSTRUCTED IN ACCORDANCE WITH LOCAL CODE REQUIREMENTS AND/OR PROJECT SPECIFICATIONS. THESE COMPONENTS SHOULD BE REVIEWED AND APPROVED BY A LICENSED DESIGN PROFESSIONAL.
4. BITUMINOUS PLIES INCLUDE APPROPRIATE SMOOTH JM SBS MODIFIED BITUMEN SHEETS APPLIED WITH HOT ASPHALT, MBR COLD APPLICATION ADHESIVE, OR HEAT WELDING TECHNIQUES AND/OR PLY FELTS APPLIED IN HOT ASPHALT.
5. JM PVC EDGE SEALANT IS NOT REQUIRED ON ALL CUT OR NON-ENCAPSULATED EDGES OF REINFORCED MEMBRANE. THIS INCLUDES FACTORY CUT MEMBRANE. SEE DETAIL PH-MS-01.
6. JM APPROVED ADHESIVES FOR USE ON VERTICAL FLASHING APPLICATIONS INCLUDES JM PVC MEMBRANE ADHESIVE (LOW VOC).
7. JM APPROVED ADHESIVES FOR JM PVC FLEECE BACKED MEMBRANE ADHERED OVER BITUMINOUS PLIES INCLUDE HOT ASPHALT.

Maximum Guarantee Term: 20 Year

Johns Manville is a manufacturer of commercial roofing products and offers this general conceptual information to you as a courtesy. This complimentary assistance is not to be used or relied upon by anyone as a substitute for professional engineering design and documentation required by building code, contract, or applicable law. By accepting these comments you agree they do not constitute any representations, endorsements of, or an assumption by Johns Manville of any liability for either the adequacy of design of this building or any other material not supplied by Johns Manville.

Note: For the most current information on general guidelines, please refer to the System Considerations tab under Commercial Roofing Products on the JM Roofing Web site. For specifications, flashing details and general installation information please refer to the Application Tools tab.

Refer to the Safe Use Instructions and product label prior to using this product.



PVC Hybrid Base & Wall Flashing With Coping Master

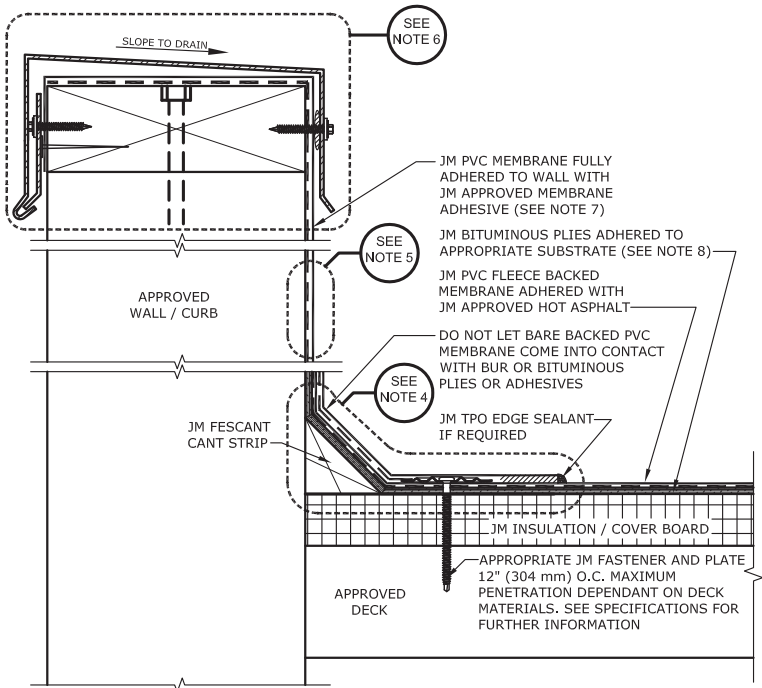

NOTES:

- REFER TO JOHNS MANVILLE WEBSITE (www.jm.com) FOR MOST UP-TO-DATE INFORMATION.
- PLEASE SEE SINGLE PLY FLASHING SPECIFICATIONS FOR A FULL DESCRIPTION OF INSTALLATION INSTRUCTIONS AND REQUIREMENTS WHICH ARE CONSIDERED A PART OF THIS DETAIL.
- ANY CARPENTRY OR METAL WORK SHOULD BE DESIGNED AND CONSTRUCTED IN ACCORDANCE WITH LOCAL CODE REQUIREMENTS AND/OR PROJECT SPECS. THESE COMPONENTS SHOULD BE REVIEWED AND APPROVED BY A LICENSED DESIGN PROFESSIONAL.
- FOR JM APPROVED BASE FLASHING FASTENING METHODS SEE PH-FW-B DETAILS. A SUFFICIENT BACKER FASTENING STRIP MUST BE INSTALLED BEHIND SUBSTRATES DIRECTLY TO STUDS FOR INSTALLATION OF TERMINATION BARS AND FLASHINGS WHEN SUBSTRATES WILL NOT SUPPORT A PROPER, SECURE INSTALLATION. SEE DETAIL PH-FW-M2I FOR BACKER DETAIL.
- FOR JM APPROVED INTERMEDIATE FLASHING FASTENING METHODS SEE P-FW-I DETAILS. MINIMUM FLASHING TERMINATION HEIGHT IS 8" ABOVE ROOF SURFACE. INTERMEDIATE ADHERED MEMBRANE FASTENING REQUIRED AT 5'-0" INTERVALS MAXIMUM, AND 18" HIGH MAXIMUM FOR NON ADHERED MEMBRANE ON CMU, BRICK, SMOOTH CONCRETE WALLS, OR ANY JM APPROVED SUBSTRATE, IE. PLYWOOD, GLASS FACED GYPSUM OR JM INVINSA. SEE DETAIL PH-FW-M2I FOR JM APPROVED FASTENING METHODS.
- FOR JM APPROVED TOP OF WALL FLASHING METHODS SEE P-FW-T DETAILS.
- JM APPROVED ADHESIVES FOR USE ON VERTICAL FLASHING APPLICATIONS INCLUDES JM PVC MEMBRANE ADHESIVE (LOW VOC).
- BITUMINOUS PLIES INCLUDE APPROPRIATE SMOOTH JM SBS MODIFIED BITUMEN SHEETS APPLIED WITH HOT ASPHALT, MBR COLD APPLICATION ADHESIVE, OR HEAT WELDING TECHNIQUES AND/OR PLY FELTS APPLIED IN HOT ASPHALT.
- JM APPROVED ADHESIVES FOR JM PVC FLEECE BACKED MEMBRANE ADHERED OVER BITUMINOUS PLIES INCLUDES HOT ASPHALT.
- JM PVC EDGE SEALANT IS OPTIONAL ON ALL CUT OR NON-ENCAPSULATED EDGES OF REINFORCED MEMBRANE. THIS INCLUDES FACTORY CUT MEMBRANE. SEE DETAIL TH-MS-01.

Maximum Guarantee Term: 20 Year

Johns Manville is a manufacturer of commercial roofing products and offers this general conceptual information to you as a courtesy. This complimentary assistance is not to be used or relied upon by anyone as a substitute for professional engineering design and documentation required by building code, contract, or applicable law. By accepting these comments you agree they do not constitute any representations, endorsements of, or an assumption by Johns Manville of any liability for either the adequacy of design of this building or any other material not supplied by Johns Manville.

Note: For the most current information on general guidelines, please refer to the System Considerations tab under Commercial Roofing Products on the JM Roofing Web site. For specifications, flashing details and general installation information please refer to the Application Tools tab.

Refer to the Safe Use Instructions and product label prior to using this product.



Hybrid Base & Wall Flashing with Coping Isometric View

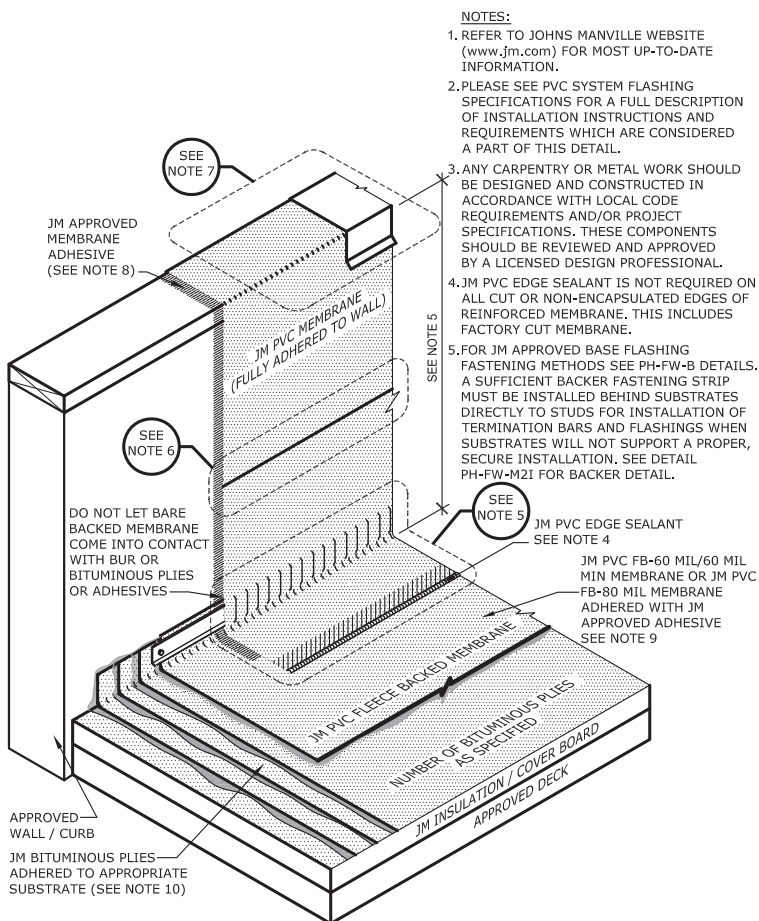

NOTES:

1. REFER TO JOHNS MANVILLE WEBSITE (www.jm.com) FOR MOST UP-TO-DATE INFORMATION.
2. PLEASE SEE PVC SYSTEM FLASHING SPECIFICATIONS FOR A FULL DESCRIPTION OF INSTALLATION INSTRUCTIONS AND REQUIREMENTS WHICH ARE CONSIDERED A PART OF THIS DETAIL.
3. ANY CARPENTRY OR METAL WORK SHOULD BE DESIGNED AND CONSTRUCTED IN ACCORDANCE WITH LOCAL CODE REQUIREMENTS AND/OR PROJECT SPECIFICATIONS. THESE COMPONENTS SHOULD BE REVIEWED AND APPROVED BY A LICENSED DESIGN PROFESSIONAL.
4. JM PVC EDGE SEALANT IS NOT REQUIRED ON ALL CUT OR NON-ENCAPSULATED EDGES OF REINFORCED MEMBRANE. THIS INCLUDES FACTORY CUT MEMBRANE.
5. FOR JM APPROVED BASE FLASHING FASTENING METHODS SEE PH-FW-B DETAILS. A SUFFICIENT BACKER FASTENING STRIP MUST BE INSTALLED BEHIND SUBSTRATES DIRECTLY TO STUDS FOR INSTALLATION OF TERMINATION BARS AND FLASHINGS WHEN SUBSTRATES WILL NOT SUPPORT A PROPER, SECURE INSTALLATION. SEE DETAIL PH-FW-M21 FOR BACKER DETAIL.

NOTES CONTINUED:

6. FOR JM APPROVED INTERMEDIATE FLASHING FASTENING METHODS SEE P-FW-I DETAILS. MINIMUM FLASHING TERMINATION HEIGHT IS 8" ABOVE ROOF SURFACE. INTERMEDIATE ADHERED MEMBRANE FASTENING REQUIRED AT 5'-0" INTERVALS MAXIMUM, AND 18" HIGH MAXIMUM FOR NON ADHERED MEMBRANE ON CMU, BRICK, SMOOTH CONCRETE WALLS, OR ANY JM APPROVED SUBSTRATE, I.E. PLYWOOD, GLASS FACED GYPSUM OR JM INVINSA. SEE DETAIL PH-FW-M21 FOR JM APPROVED FASTENING METHODS.
7. FOR JM APPROVED TOP OF WALL FLASHING METHODS SEE P-FW-T DETAILS.
8. JM APPROVED ADHESIVES FOR USE ON VERTICAL FLASHING APPLICATIONS INCLUDES JM PVC MEMBRANE ADHESIVES (LOW VOC).
9. JM APPROVED ADHESIVES FOR JM PVC FLEECE BACKED MEMBRANE ADHERED OVER BITUMINOUS PLYS INCLUDES HOT ASPHALT.
10. JM BITUMINOUS PLYS INCLUDE APPROPRIATE SMOOTH SBS MODIFIED BITUMEN SHEETS APPLIED WITH HOT ASPHALT, MBR COLD APPLICATION ADHESIVE, OR HEAT WELDED TECHNIQUES, AND/OR PLY FELTS APPLIED IN HOT ASPHALT.

Maximum Guarantee Term: 20 Year

Johns Manville is a manufacturer of commercial roofing products and offers this general conceptual information to you as a courtesy. This complimentary assistance is not to be used or relied upon by anyone as a substitute for professional engineering design and documentation required by building code, contract, or applicable law. By accepting these comments you agree they do not constitute any representations, endorsements of, or an assumption by Johns Manville of any liability for either the adequacy of design of this building or any other material not supplied by Johns Manville.

Note: For the most current information on general guidelines, please refer to the System Considerations tab under Commercial Roofing Products on the JM Roofing Web site. For specifications, flashing details and general installation information please refer to the Application Tools tab.

Refer to the Safe Use Instructions and product label prior to using this product.



Highwall Flashing With Metal Backing Strip Isometric View

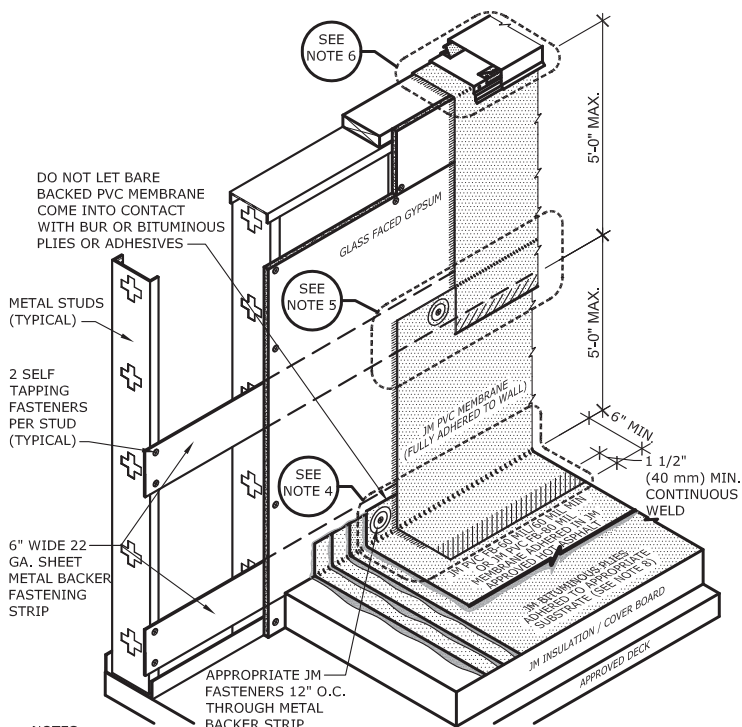

NOTES:

1. REFER TO JOHNS MANVILLE WEBSITE (www.jm.com) FOR MOST UP-TO-DATE INFORMATION.
2. PLEASE SEE SINGLE PLY FLASHING SPECIFICATIONS FOR A FULL DESCRIPTION OF INSTALLATION INSTRUCTIONS AND REQUIREMENTS WHICH ARE CONSIDERED A PART OF THIS DETAIL.
3. ANY CARPENTRY OR METAL WORK SHOULD BE DESIGNED AND CONSTRUCTED IN ACCORDANCE WITH LOCAL CODE REQUIREMENTS AND/OR PROJECT SPECS. THESE COMPONENTS SHOULD BE REVIEWED AND APPROVED BY A LICENSED DESIGN PROFESSIONAL.
4. FOR JM APPROVED BASE FLASHING FASTENING METHODS SEE PH-FW-B DETAILS. A SUFFICIENT BACKER FASTENING STRIP MUST BE INSTALLED BEHIND SUBSTRATES DIRECTLY TO STUDS FOR INSTALLATION OF TERMINATION BARS AND FLASHINGS WHEN SUBSTRATES WILL NOT SUPPORT A PROPER, SECURE INSTALLATION. SEE DETAIL PH-FW-M21 FOR BACKER DETAIL.
5. FOR JM APPROVED INTERMEDIATE FLASHING FASTENING METHODS SEE P-FW-I DETAILS. MINIMUM FLASHING TERMINATION HEIGHT IS 8" ABOVE ROOF SURFACE. INTERMEDIATE ADHERED MEMBRANE FASTENING REQUIRED AT 5'-0" INTERVALS MAXIMUM, AND 18" HIGH MAXIMUM FOR NON ADHERED MEMBRANE ON CMU, BRICK, SMOOTH CONCRETE WALLS, OR ANY JM APPROVED SUBSTRATE, IE, PLYWOOD, GLASS FACED GYPSUM OR JM INVINSA. SEE DETAIL PH-FW-M21 FOR JM APPROVED FASTENING METHODS.
6. FOR JM APPROVED TOP OF WALL FLASHING METHODS SEE P-FW-T DETAILS.
7. JM APPROVED ADHESIVES FOR USE ON VERTICAL FLASHING APPLICATIONS INCLUDES JM PVC MEMBRANE ADHESIVE (LOW VOC).
8. JM BITUMINOUS PLIES INCLUDE APPROPRIATE SMOOTH SBS MODIFIED BITUMEN SHEETS APPLIED WITH HOT ASPHALT, MBR COLD APPLICATION ADHESIVE, OR HEAT WELDED TECHNIQUES, AND/OR PLY FELTS APPLIED IN HOT ASPHALT.
9. JM APPROVED ADHESIVES FOR JM PVC FLEECE BACKED MEMBRANE ADHERED OVER BITUMINOUS PLIES INCLUDE HOT ASPHALT.
10. JM PVC EDGE SEALANT IS NOT REQUIRED ON ALL CUT OR NON-ENCAPSULATED OF REINFORCED MEMBRANE. THIS INCLUDES FACTORY CUT MEMBRANE. SEE DETAIL PH-MS-01.

Maximum Guarantee Term: 20 Year

Johns Manville is a manufacturer of commercial roofing products and offers this general conceptual information to you as a courtesy. This complimentary assistance is not to be used or relied upon by anyone as a substitute for professional engineering design and documentation required by building code, contract, or applicable law. By accepting these comments you agree they do not constitute any representations, endorsements of, or an assumption by Johns Manville of any liability for either the adequacy of design of this building or any other material not supplied by Johns Manville.

Note: For the most current information on general guidelines, please refer to the System Considerations tab under Commercial Roofing Products on the JM Roofing Web site. For specifications, flashing details and general installation information please refer to the Application Tools tab.

Refer to the Safe Use Instructions and product label prior to using this product.



PVC Presto Weld Drip Edge

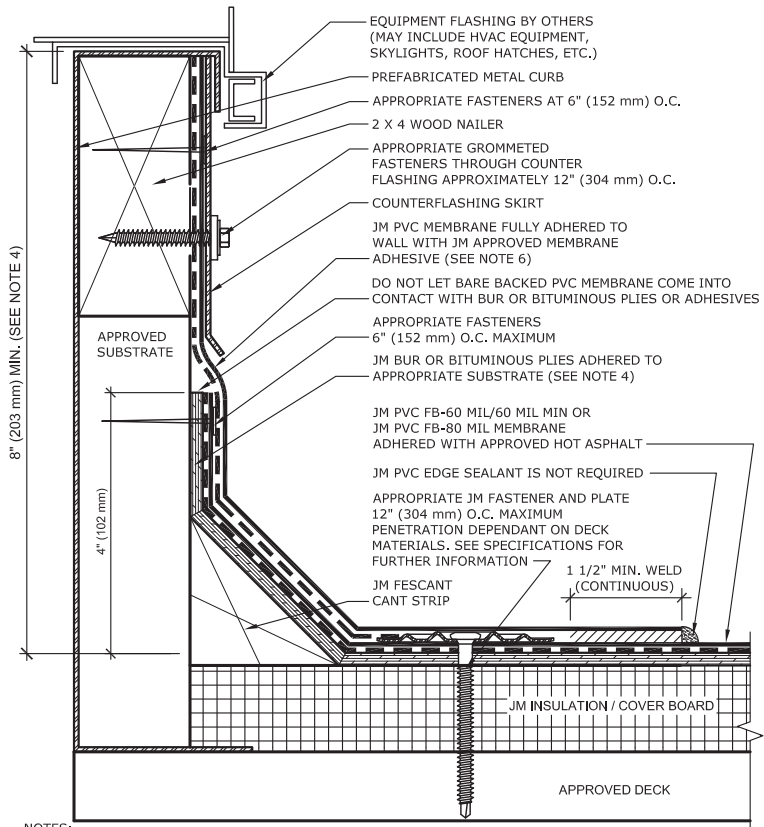

NOTES:

- REFER TO JOHNS MANVILLE WEBSITE (www.jm.com) FOR MOST UP-TO-DATE INFORMATION.
- PLEASE SEE SINGLE PLY FLASHING SPECIFICATIONS FOR A FULL DESCRIPTION OF INSTALLATION INSTRUCTIONS AND REQUIREMENTS WHICH ARE CONSIDERED A PART OF THIS DETAIL.
- ANY CARPENTRY OR METAL WORK SHOULD BE DESIGNED AND CONSTRUCTED IN ACCORDANCE WITH LOCAL CODE REQUIREMENTS AND/OR PROJECT SPECIFICATIONS. THESE COMPONENTS SHOULD BE REVIEWED AND APPROVED BY A LICENSED DESIGN PROFESSIONAL.
- BITUMINOUS PLIES INCLUDE APPROPRIATE SMOOTH JM SBS MODIFIED BITUMEN SHEETS APPLIED WITH HOT ASPHALT, MBR COLD APPLICATION ADHESIVE, OR HEAT WELDING TECHNIQUES AND/OR PLY FELTS APPLIED IN HOT ASPHALT.
- JM PVC EDGE SEALANT IS OPTIONAL ON ALL CUT OR NON-ENCAPSULATED EDGES OF REINFORCED MEMBRANE. THIS INCLUDES FACTORY CUT MEMBRANE. SEE DETAIL PH-MS-01.
- JM APPROVED ADHESIVES FOR USE ON VERTICAL FLASHING APPLICATIONS INCLUDES JM PVC MEMBRANE ADHESIVE (LOW VOC), AND PVC MEMBRANE ADHESIVE (WATER BASED).
- JM APPROVED ADHESIVES FOR JM TPO FLEECE BACKED MEMBRANE ADHERED OVER BITUMINOUS PLIES INCLUDE HOT ASPHALT.
- HEIGHT OF CURB TO BE ADJUSTED WITH NAILERS. IT IS PREFERRED TO RAISE CURB ONTO NAILERS TO EXTEND FLASHING HEIGHT.
- SEE PH-FW-B DETAILS FOR JM APPROVED BASE FLASHING TIE IN TERMINATION METHODS.

Maximum Guarantee Term: 30 Year

Johns Manville is a manufacturer of commercial roofing products and offers this general conceptual information to you as a courtesy. This complimentary assistance is not to be used or relied upon by anyone as a substitute for professional engineering design and documentation required by building code, contract, or applicable law. By accepting these comments you agree they do not constitute any representations, endorsements of, or an assumption by Johns Manville of any liability for either the adequacy of design of this building or any other material not supplied by Johns Manville.

Note: For the most current information on general guidelines, please refer to the System Considerations tab under Commercial Roofing Products on the JM Roofing Web site. For specifications, flashing details and general installation information please refer to the Application Tools tab.

Refer to the Safe Use Instructions and product label prior to using this product.



Prefab Metal Curb Base Flashing

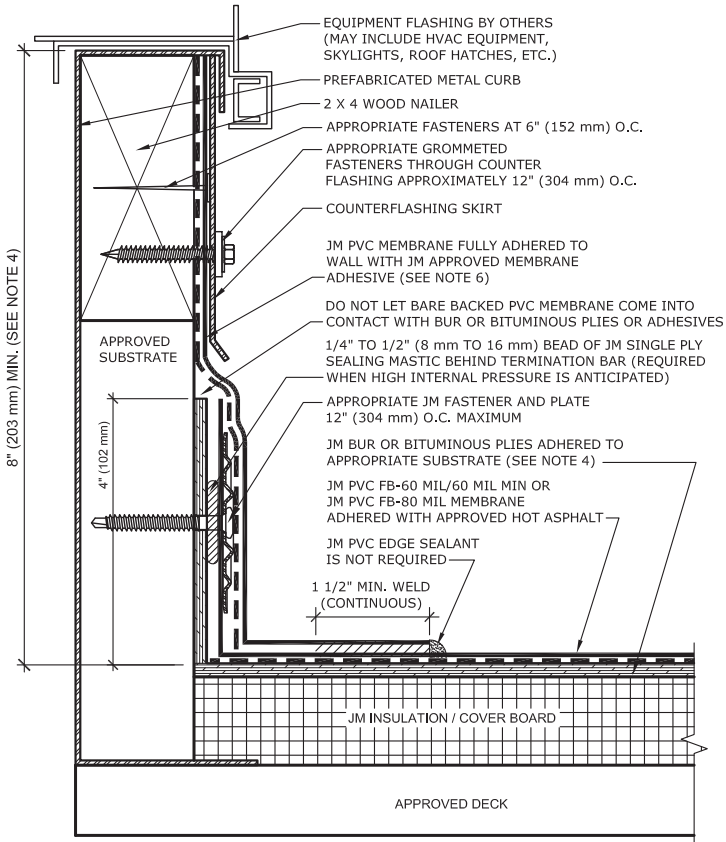

NOTES:

- REFER TO JOHNS MANVILLE WEBSITE (www.jm.com) FOR MOST UP-TO-DATE INFORMATION.
- PLEASE SEE SINGLE PLY FLASHING SPECIFICATIONS FOR A FULL DESCRIPTION OF INSTALLATION INSTRUCTIONS AND REQUIREMENTS WHICH ARE CONSIDERED A PART OF THIS DETAIL.
- ANY CARPENTRY OR METAL WORK SHOULD BE DESIGNED AND CONSTRUCTED IN ACCORDANCE WITH LOCAL CODE REQUIREMENTS AND/OR PROJECT SPECIFICATIONS. THESE COMPONENTS SHOULD BE REVIEWED AND APPROVED BY A LICENSED DESIGN PROFESSIONAL.
- BITUMINOUS PLIES INCLUDE APPROPRIATE SMOOTH JM SBS MODIFIED BITUMEN SHEETS APPLIED WITH HOT ASPHALT, MBR COLD APPLICATION ADHESIVE, OR HEAT WELDING TECHNIQUES AND/OR PLY FELTS APPLIED IN HOT ASPHALT.
- JM PVC EDGE SEALANT IS NOT REQUIRED ON ALL CUT OR NON-ENCAPSULATED EDGES OF REINFORCED MEMBRANE. THIS INCLUDES FACTORY CUT MEMBRANE. SEE DETAIL PH-MS-01.
- JM APPROVED ADHESIVES FOR USE ON VERTICAL FLASHING APPLICATIONS INCLUDES JM PVC MEMBRANE ADHESIVE (LOW VOC).
- JM APPROVED ADHESIVES FOR JM PVC FLEECE BACKED MEMBRANE ADHERED OVER BITUMINOUS PLIES INCLUDE HOT ASPHALT.
- HEIGHT OF CURB TO BE ADJUSTED WITH NAILERS. IT IS PREFERRED TO RAISE CURB ONTO NAILERS TO EXTEND FLASHING HEIGHT.
- SEE PH-FW-B DETAILS FOR JM APPROVED BASE FLASHING TIE IN TERMINATION METHODS.

Maximum Guarantee Term: 30 Year

Johns Manville is a manufacturer of commercial roofing products and offers this general conceptual information to you as a courtesy. This complimentary assistance is not to be used or relied upon by anyone as a substitute for professional engineering design and documentation required by building code, contract, or applicable law. By accepting these comments you agree they do not constitute any representations, endorsements of, or an assumption by Johns Manville of any liability for either the adequacy of design of this building or any other material not supplied by Johns Manville.

Note: For the most current information on general guidelines, please refer to the System Considerations tab under Commercial Roofing Products on the JM Roofing Web site. For specifications, flashing details and general installation information please refer to the Application Tools tab.

Refer to the Safe Use Instructions and product label prior to using this product.



Pipe Boot

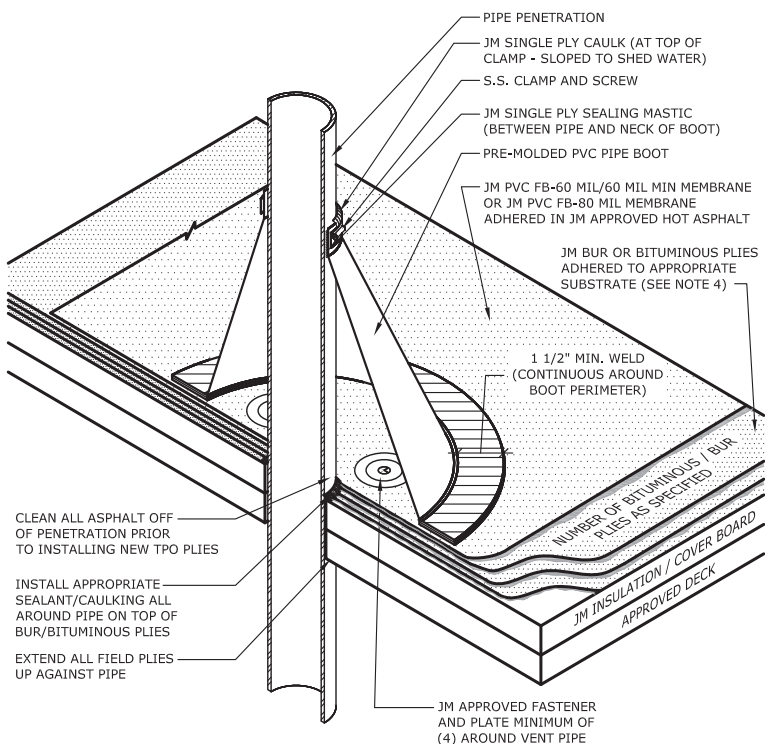

NOTES:

1. REFER TO JOHNS MANVILLE WEBSITE (www.jm.com) FOR MOST UP-TO-DATE INFORMATION.
2. PLEASE SEE SINGLE PLY FLASHING SPECIFICATIONS FOR A FULL DESCRIPTION OF INSTALLATION INSTRUCTIONS AND REQUIREMENTS WHICH ARE CONSIDERED A PART OF THIS DETAIL.
3. ANY CARPENTRY OR METAL WORK SHOULD BE DESIGNED AND CONSTRUCTED IN ACCORDANCE WITH LOCAL CODE REQUIREMENTS AND/OR PROJECT SPECIFICATIONS. THESE COMPONENTS SHOULD BE REVIEWED AND APPROVED BY A LICENSED DESIGN PROFESSIONAL.
4. BITUMINOUS PLIES INCLUDE APPROPRIATE SMOOTH JM SBS MODIFIED BITUMEN SHEETS APPLIED WITH HOT ASPHALT, MBR COLD APPLICATION ADHESIVE, OR HEAT WELDING TECHNIQUES AND/OR PLY FELTS APPLIED IN HOT ASPHALT.
5. JM PVC EDGE SEALANT IS OPTIONAL ON ALL CUT OR NON-ENCAPSULATED OF REINFORCED MEMBRANE. THIS INCLUDES FACTORY CUT MEMBRANE, SEE DETAIL PH-MS-01.
6. JM APPROVED ADHESIVES FOR JM PVC FLEECE BACKED MEMBRANE ADHERED OVER BITUMINOUS PLIES INCLUDE HOT ASPHALT.

Maximum Guarantee Term: 20 Year

Johns Manville is a manufacturer of commercial roofing products and offers this general conceptual information to you as a courtesy. This complimentary assistance is not to be used or relied upon by anyone as a substitute for professional engineering design and documentation required by building code, contract, or applicable law. By accepting these comments you agree they do not constitute any representations, endorsements of, or an assumption by Johns Manville of any liability for either the adequacy of design of this building or any other material not supplied by Johns Manville.

Note: For the most current information on general guidelines, please refer to the System Considerations tab under Commercial Roofing Products on the JM Roofing Web site. For specifications, flashing details and general installation information please refer to the Application Tools tab.

Refer to the Safe Use Instructions and product label prior to using this product.



PVC Fleece Backed Membrane Butted End Lap

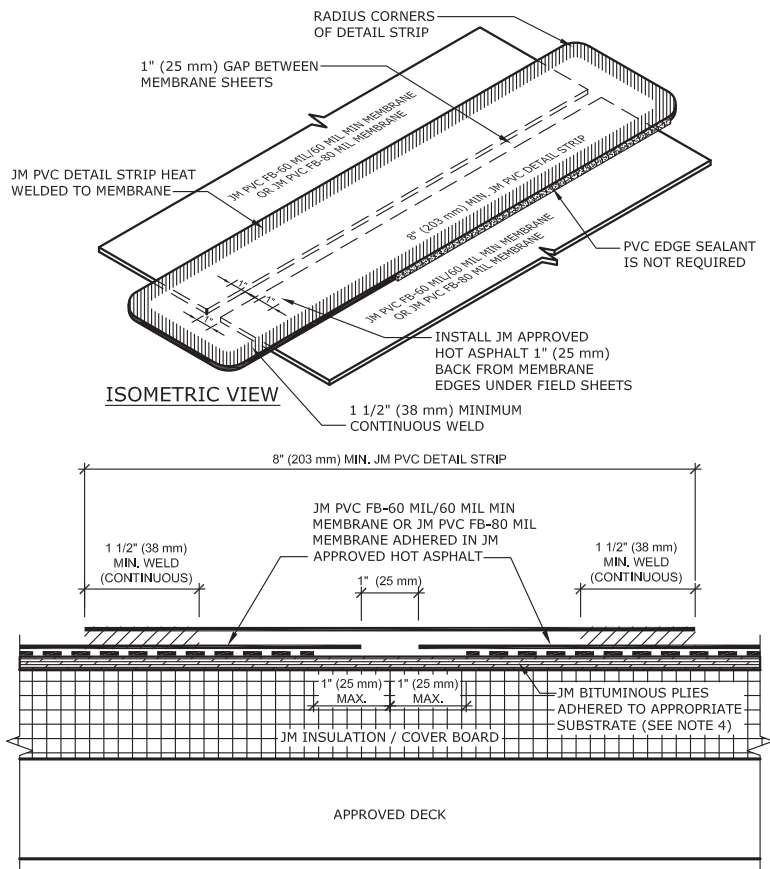

NOTES:

1. REFER TO JOHNS MANVILLE WEBSITE (www.jm.com) FOR MOST UP-TO-DATE INFORMATION.
2. PLEASE SEE SINGLE PLY FLASHING SPECIFICATIONS FOR A FULL DESCRIPTION OF INSTALLATION INSTRUCTIONS AND REQUIREMENTS WHICH ARE CONSIDERED A PART OF THIS DETAIL.
3. ANY CARPENTRY OR METAL WORK SHOULD BE DESIGNED AND CONSTRUCTED IN ACCORDANCE WITH LOCAL CODE REQUIREMENTS AND/OR PROJECT SPECIFICATIONS. THESE COMPONENTS SHOULD BE REVIEWED AND APPROVED BY A LICENSED DESIGN PROFESSIONAL.
4. BITUMINOUS PLIES INCLUDE APPROPRIATE SMOOTH JM SBS MODIFIED BITUMEN SHEETS APPLIED WITH HOT ASPHALT, MBR COLD APPLICATION ADHESIVE, OR HEAT WELDING TECHNIQUES AND/OR PLY FELTS APPLIED IN HOT ASPHALT.
5. JM PVC EDGE SEALANT IS NOT REQUIRED ON ALL CUT OR NON-ENCAPSULATED EDGES OF REINFORCED MEMBRANE. THIS INCLUDES FACTORY CUT MEMBRANE. SEE DETAIL PH-MS-01.
6. JM APPROVED ADHESIVES FOR JM PVC FLEECE BACKED MEMBRANE ADHERED OVER BITUMINOUS PLIES INCLUDE HOT ASPHALT.

Maximum Guarantee Term: 20 Year

Johns Manville is a manufacturer of commercial roofing products and offers this general conceptual information to you as a courtesy. This complimentary assistance is not to be used or relied upon by anyone as a substitute for professional engineering design and documentation required by building code, contract, or applicable law. By accepting these comments you agree they do not constitute any representations, endorsements of, or an assumption by Johns Manville of any liability for either the adequacy of design of this building or any other material not supplied by Johns Manville.

Note: For the most current information on general guidelines, please refer to the System Considerations tab under Commercial Roofing Products on the JM Roofing Web site. For specifications, flashing details and general installation information please refer to the Application Tools tab.

Refer to the Safe Use Instructions and product label prior to using this product.

PEAK *Johns Manville* ADVANTAGE

One manufacturer, one full-system guarantee

Johns Manville offers the most comprehensive guarantee in the roofing industry. That's the advantage you can expect from a longtime, dependable leader in the roofing industry along with the financial backing from Berkshire Hathaway.



facebook.com/JohnsManville



[@JMRoofingSystem](https://twitter.com/JMRoofingSystem)



JohnsManvillevideos



www.jmroofing.news



717 17th St,
Denver, CO 80202
(800) 922-5922

www.jm.com/roofing