

# INSTALLATION INSTRUCTIONS



# SPIDER<sup>®</sup> PLUS

INTERLOCKING FIBER TECHNOLOGY



**SMART, CLEAN & VERSATILE**

The premium blow-in insulation solution

# PREPARATION AT SHOP

Spider Plus Coverage Chart							
Wall Type	R-Value	RSI	Density (lbs/ft <sup>3</sup> )	ft <sup>2</sup> /bag	m <sup>2</sup> /bag	bags/1000ft <sup>2</sup>	bags/100m <sup>2</sup>
2x4	14	2.5	1.5	68.6	6.4	14.6	15.7
	15	2.6	1.8	57.1	5.3	17.5	18.8
2x6	22 US / 23 CAN	3.9 US / 4.1 CAN	1.5	43.6	4.1	22.9	24.7
	23 US / 24 CAN	4.1 US / 4.2 CAN	1.8	36.4	3.4	27.5	29.2

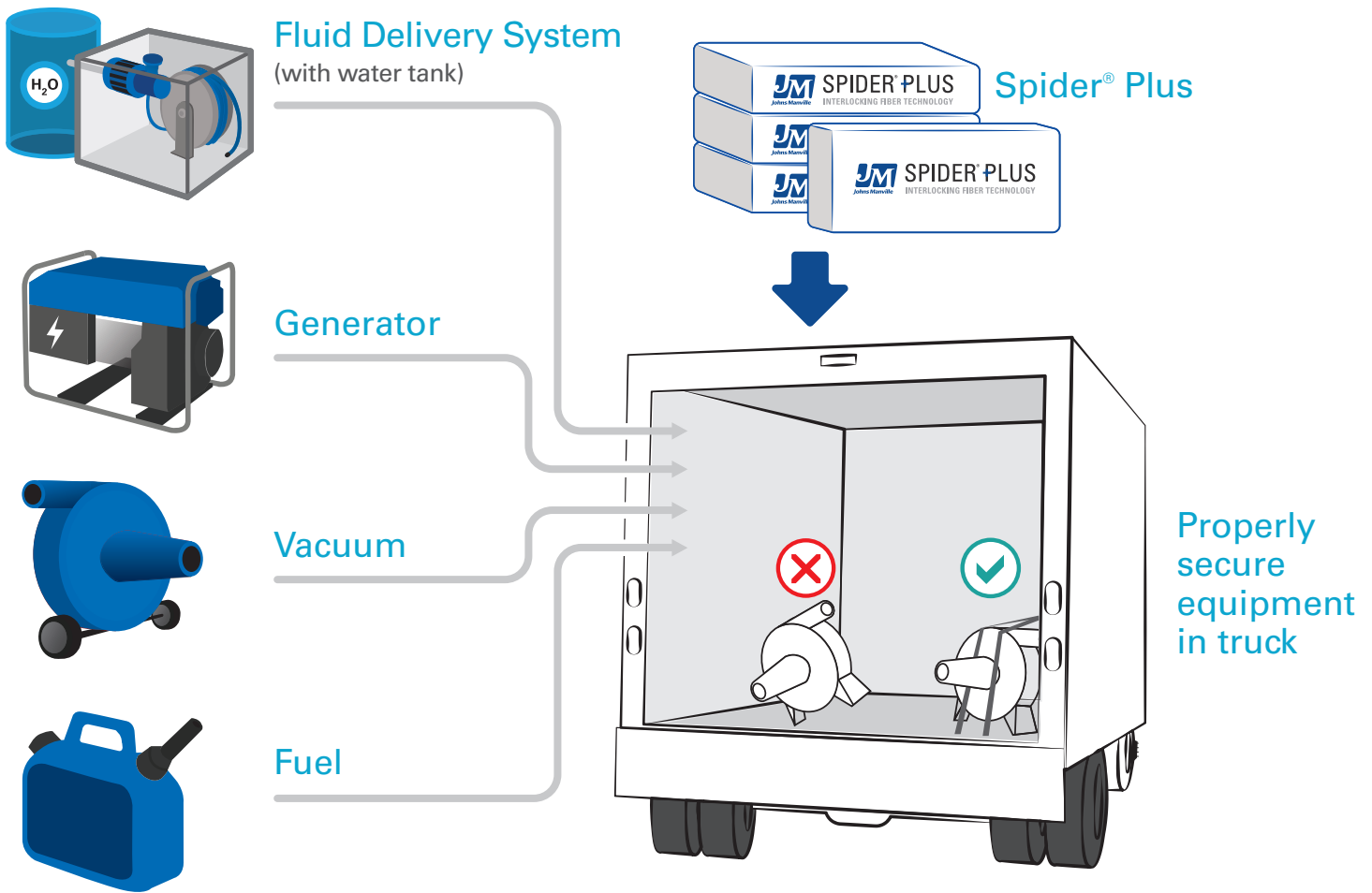

Additional Equipment & Supplies			
Scrubber	Water Bucket	Batt Material	Extension Cords
Spray Nozzle (HDN)	Foam Sealant	Rolls of Poly	Tool Box
Extra Spray Tips	Netting	Duct Tape	Hose Clamps
Vacuum Hose	Stapler & Staples	Scaffold & Ladder	Brooms
Extra Lighting	Orifice Gauge	Fish Scale	Weighing Bags

# PREPARATION AT JOB



# SPIDER<sup>®</sup> PLUS

INTERLOCKING FIBER TECHNOLOGY

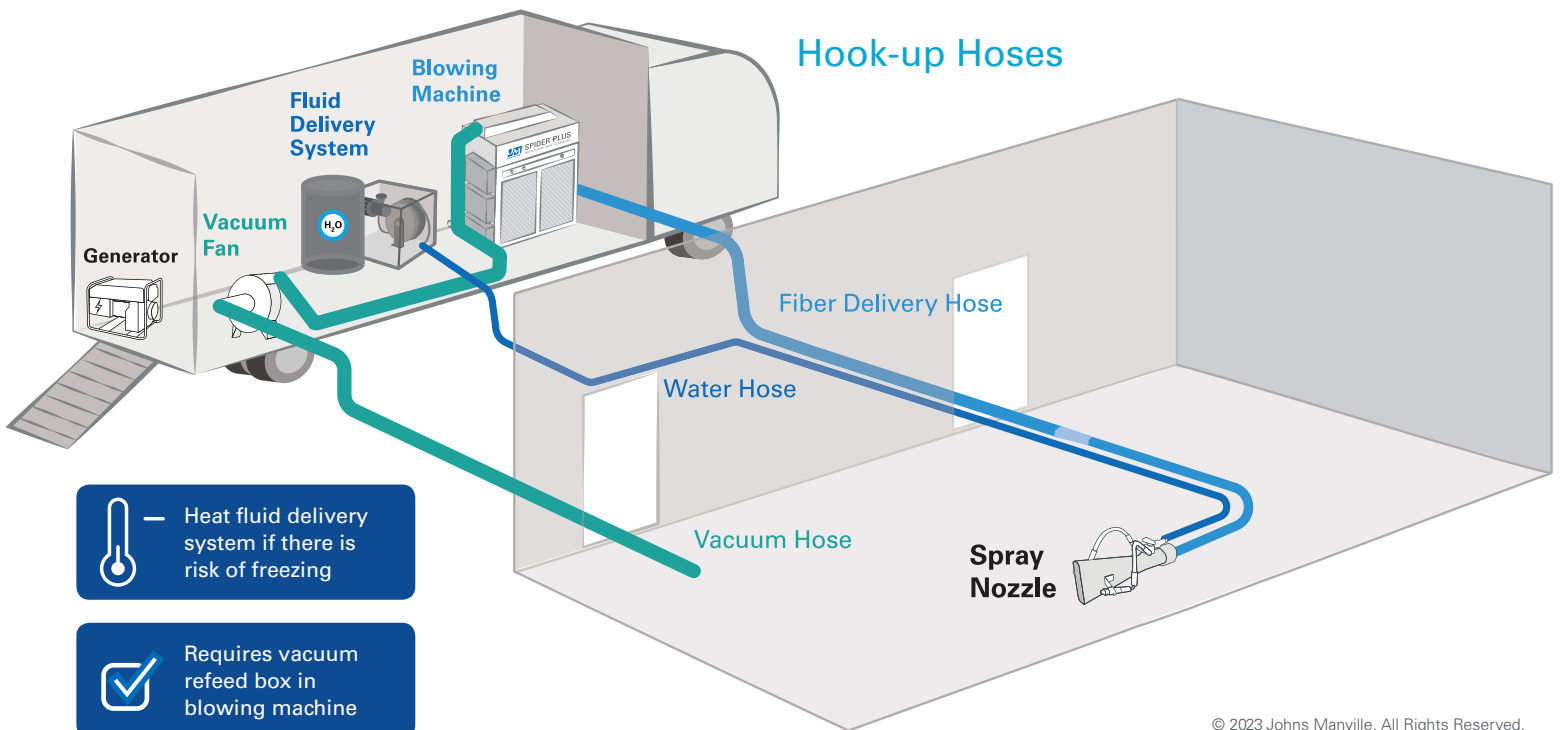
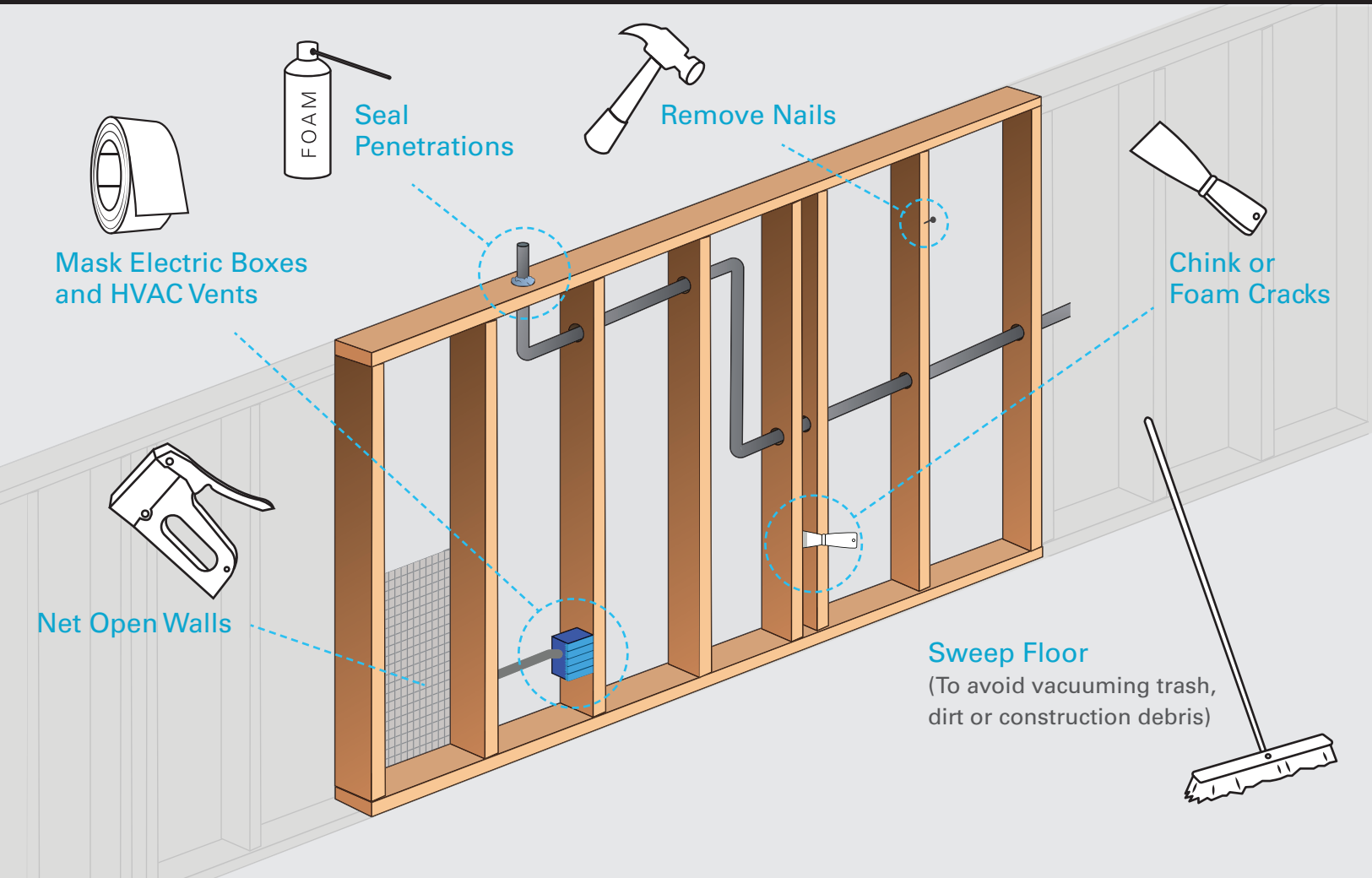

## Blowing Machine

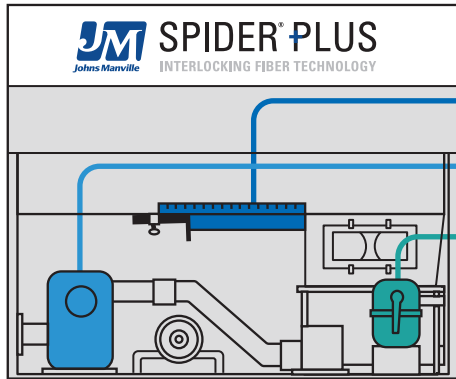

Slide Gate

Air Flow

Gear

RPM

Orifice PSI

Notes:

## Fluid Delivery System

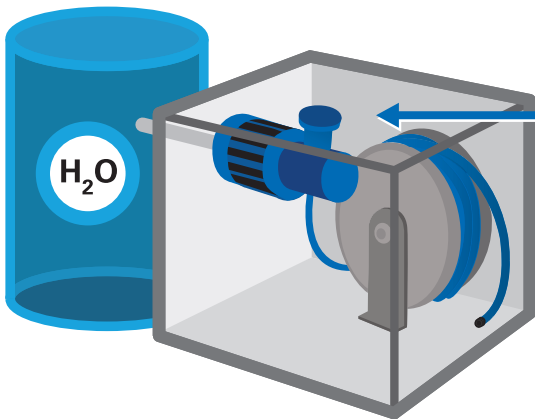

PSI

--

Recommended pressure

1000 psi for 650025 tips

## EQUIPMENT SETUP NOTES:

1. Set up blowing machine to achieve 1.5 to 1.6 psi **orifice** pressure (at the end of the blow hose) with no material flowing (2.0 to 2.5 psi for overhead application).
2. Set up material feed rate to achieve approximately 20 lbs/min of Spider Plus.
3. Make sure water spray tips are clean and undamaged.
4. Set up water pump to run at 1000 psi at the gauge in the fluid delivery system.
5. Check water flow rate at nozzles to ensure approximately 2.2 lbs/min and a wide mist spray pattern (65° wide mist).
6. Record setup parameters to speed up future setup process.
7. See next page for further instructions on measuring water and Spider Plus flow rates.

# SPRAY SETTINGS

## Air Flow (Orifice Air Pressure)

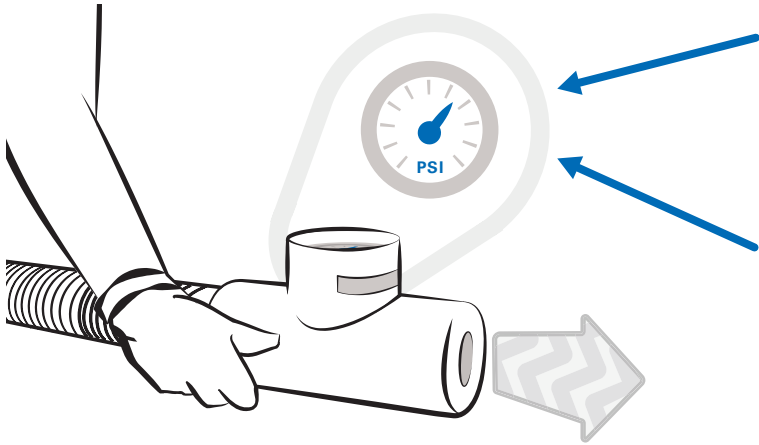



Walls
1.5 to 1.6 psi

Overhead
2.0 to 2.5 psi

Use pressure gauge attachment on end of hose and test with air only (no fiber feed)

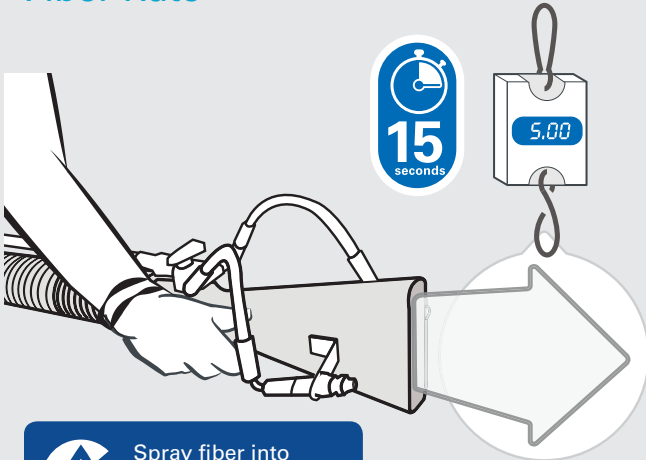
## Fiber Rate





 Spray fiber into a vented bag (no water)

Target Range

Weight of Spider Plus Sprayed in 15 Seconds	Spider Plus Delivery Rate (lbs/min)
3.0 lbs	12
3.5 lbs	14
4.0 lbs	16
4.5 lbs	18
5.0 lbs	20
5.5 lbs	22
6.0 lbs	24
6.5 lbs	26
7.0 lbs	28

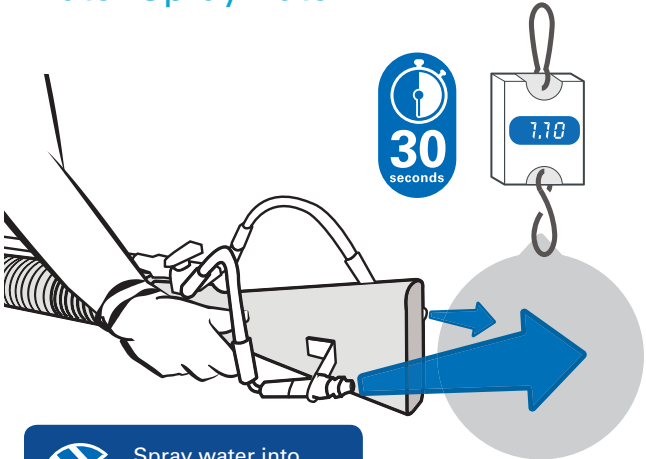
## Water Spray Rate



 Spray water into a plastic bag (no fiber)

Target Range

Weight of Water Sprayed in 30 Seconds	Spider Plus Delivery Rate (lbs/min)
0.7 lbs	1.4
0.8 lbs	1.6
0.9 lbs	1.8
1.0 lbs	2.0
1.1 lbs	2.2
1.2 lbs	2.4
1.3 lbs	2.6
1.4 lbs	2.8
1.5 lbs	3.0

## WALLS

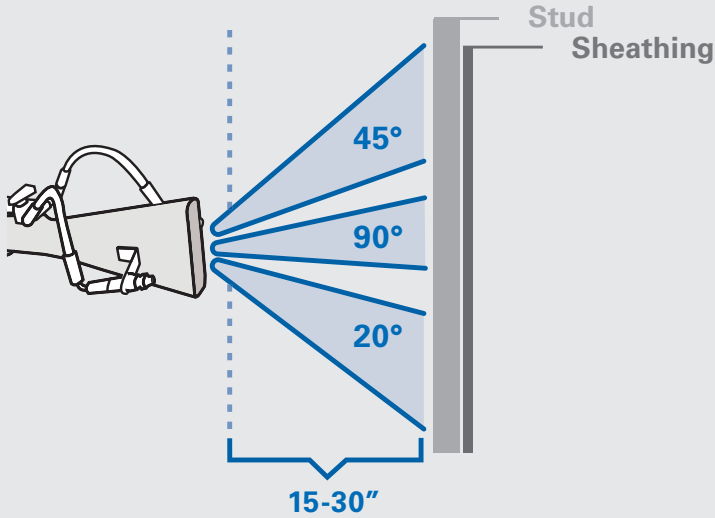

### Spraying:

Using a high density nozzle (HDN), spray at a distance of 15-30 inches (closer for higher density, further for lower density).

*When turning spray nozzle on and off, the water spray should be the first on and the last off. If needed, move nozzle closer at the top and bottom of cavity to avoid low density in these areas.*

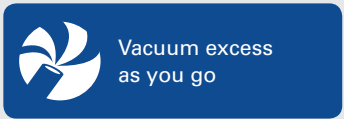

### Scrubbing:

Scrub the face of the cavities to remove excess material. Vacuum flyoff and excess material into refeed system. Maintain a sufficient quantity of new material in the hopper to avoid spraying with only refeed.

*A 3-person crew is recommended to keep up with spraying, scrubbing and vacuuming to ensure minimal fluctuation in refeed rate.*

## OVERHEAD

Establish a foundation in the end of a cavity, then fill the cavity in layers. Spider is intended to be used in overhead applications only when the material will be covered with drywall or another method to ensure long-term longevity of the insulation.

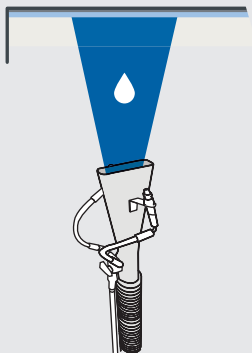

**1** Water Pre-spray\*

*\*Not necessary for some applications*

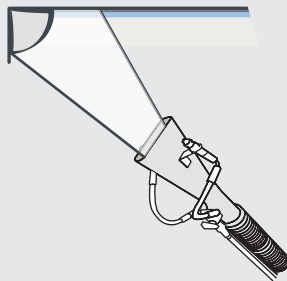

**2** End of Cavity

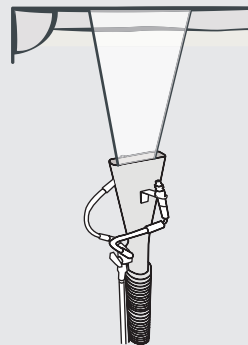

**3** Base Coat

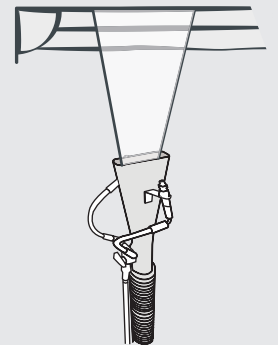

**4** Fill Cavity

# CHECKING DENSITY

## BAG COUNT METHOD



### Bag Count

R-Value	Wall Type	Bags per 1000ft <sup>2</sup>	Bags per 100m <sup>2</sup>
14	2x4	14.6	15.7
15		17.5	18.8
22 US / 23 CAN	2x6	22.9	24.7
23 US / 24 CAN		27.5	29.2

## R-VALUE GAUGE METHOD

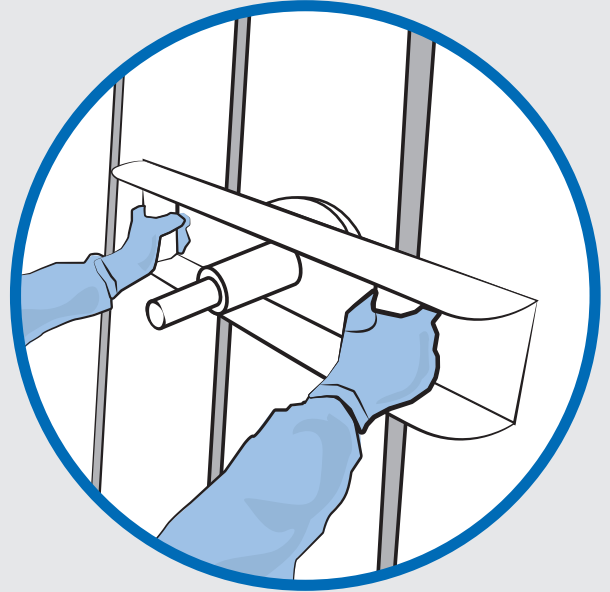

(Set up for either 2x4 or 2x6 construction)

## MATERIAL REMOVAL METHOD

Remove sample of insulation to measure density

Weigh sample

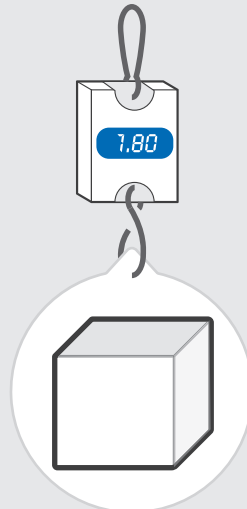
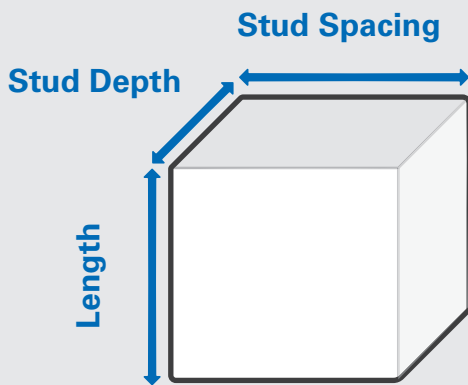

### Density Sample Length

2x4, 16" o.c.	34 inches
2x6, 16" o.c.	21.75 inches
2x6, 24" o.c.	14 inches

### Target Sample Weight

Wall	R-Value	Weight (lbs)
2x4	14	1.4 to 1.6
	15	1.7 to 2.0
2x6	22 US / 23 CAN	1.4 to 1.6
	23 US / 24 CAN	1.7 to 2.0

# JOB CLEANUP



**SPIDER® PLUS**  
INTERLOCKING FIBER TECHNOLOGY

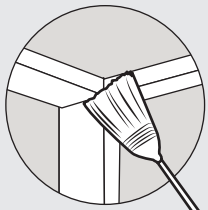

Clean the Details

Remove Masking



Sweep the Floor

## Properly secure equipment in truck

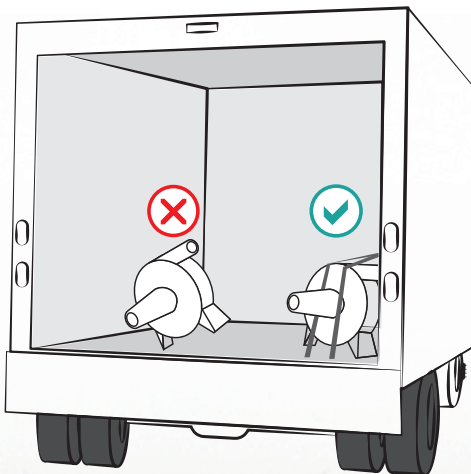

— Be sure to store fluid delivery system in a location that will not freeze when not in use to prevent hose and fittings from bursting